

**TCL**

**LED TV**

**OPERATION MANUAL**

For use with models: P4/P6/C4/C6/C8/X4/X7/P8M series

**COLOUR YOUR WORLD**



*Figures and illustrations in this User's Guide are provided for reference only and may differ from actual product appearance. Product design and specifications may be changed without notice.*

# Table of Contents

## Chapter 1: Safety Information

<b>Precautions</b> .....	3
Warning .....	3
Product .....	3
Power and Plug .....	3
Power Cord and Signal Cable .....	3
Use Environment .....	3
Cleaning .....	3
Hanging the TV Set on the Wall .....	3

## Chapter 2: Connections and Setup

<b>TV Buttons</b> .....	4
<b>Initial Setup</b> .....	4
<b>Sockets</b> .....	6
<b>Remote Control Functions</b> .....	7
Installing Batteries .....	7
<b>Exclusive Remote Control</b> .....	8
How to use the remote control .....	8
Installing Batteries .....	8
<b>Network Connection</b> .....	9
<b>Switching On</b> .....	10
<b>Switching Off</b> .....	10

## Chapter 3: Basic TV Operations

<b>Accessing Channels</b> .....	11
<b>Watching Connected Devices</b> .....	11
<b>Adjusting Volume</b> .....	11
<b>Accessing Smart TV Homepage</b> .....	11
<b>Accessing T recommended</b> .....	11
<b>Accessing Google Play</b> .....	11
<b>Using System Settings menu</b> .....	12
<b>Using Instant Power On</b> .....	12
<b>Using TV Settings menu</b> .....	12

## Chapter 4: Using more of your TV

<b>Installing Channels</b> .....	13
<b>Using Subtitles</b> .....	13
Turning on/off subtitles .....	13
Enabling subtitle languages on digital TV channels .....	13
Selecting a subtitle type on digital TV channels .....	13
<b>Using Teletext</b> .....	13
Selecting decoding page language .....	13
Digital Teletext language .....	13
<b>Network waking up</b> .....	13
<b>T-Link</b> .....	14
Enabling or disabling T-Link .....	14
Using Auto Power on .....	14
Using Auto standby .....	14
<b>Time Shift</b> .....	14
Quick Access of Time Shift .....	14
<b>HbbTV</b> .....	14
HbbTV access .....	14
HbbTV deactivation .....	14
<b>Google Cast</b> .....	15
<b>T-Cast</b> .....	15
<b>PVR (Personal Video Recorder)</b> .....	15
<b>Using EPG (Electronic Program Guide)</b> .....	15
<b>Bluetooth Function</b> .....	16
<b>Freeview Plus</b> .....	16
What you need .....	16
To launch Freeview Plus .....	16
<b>Netflix Settings</b> .....	16
<b>Password in Parental Control</b> .....	16

## Chapter 5: Other Information

<b>Problems &amp; Solutions</b> .....	17
<b>Troubleshooting</b> .....	18
<b>Legal Statement</b> .....	19
<b>Licence</b> .....	20

## Precautions

Read all of the instructions before operating the set. Keep these instructions well for future use.

## Warning

Never place a television set in an unstable location. A television set may fall, causing serious personal injury or death. Many injuries, particularly to children, can be avoided by taking simple precautions such as:

- Using cabinets or stands recommended by the manufacturer of the television set.
- Only using furniture that can safely support the television set.
- Ensuring the television set is not overhanging the edge of the supporting furniture.
- Not placing the television set on tall furniture (for example, cupboards or bookcases) without anchoring both the furniture and the television set to a suitable support.
- Not placing the television set on cloth or other materials that may be located between the television set and supporting furniture.
- Educating children about the dangers of climbing on furniture to reach the television set or its controls.

If your existing television set is being retained and relocated, the same considerations as above should be applied.

## Product

- Do not block or cover the ventilation openings on the back cover.
- Do not push objects of any kind into this unit through the cabinet slots as they could touch the current carrying parts or short-circuit parts, resulting in fire, electric shock, or damage to the unit.
- Do not attempt to open the cabinet as this may cause damage. There are no parts inside you can service by yourself. Refer all servicing to qualified personnel.
- Do not touch the screen surface with fingers as this may scratch or mar the TV screen.
- Do not impact the TV screen with hard pressure as this may damage the TV screen severely.
- This appliance is not intended for use by young children or infirm persons without supervision. Young children should be supervised to ensure that they do not play with the appliance.

## Power and Plug

- Unplug the set under the following conditions:
  - If the set will not be used for a long period of time.
  - If the power cord or the power outlet/plug is damaged.
  - Follow the instructions to install and adjust the product. Adjust those controls that are covered in these operating instructions as improper adjustment of other controls may result in damage. If this happens, unplug the set and refer to the service personnel.
  - If the set is subject to impact or has been dropped

and the cabinet has been damaged.

- Where the mains plug or an appliance coupler is used as disconnect device, the disconnect device shall remain readily operable.

## Power Cord and Signal Cable

- Do not allow anything to rest on or roll over the power cord and the signal cable.
- Protect the power cord and the signal cable from being trampled.
- Do not overload the power cord or the power outlet.
- Do not expose the power cord and the signal cable to moisture.

## Use Environment

- Do not place the set on an unstable cart, stand, or table.
- Place the set on a place that allows good ventilation.
- Do not use the set near damp, and cold areas.
- Do not expose the set to excessive heat such as direct sunlight, fire, or the like and no naked flame sources, such as lighted candles, should be placed on the apparatus.
- Do not expose the set to dripping or splashing and no objects filled with liquids, such as vases, shall be placed on the apparatus.
- Do not use the set in dusty environments.
- Operating Temperature: 5°C to 35°C (41°F to 95°F)  
Operating Humidity: 20% to 80%, non-condensing  
Storage Temperature: -15°C to 45°C (5°F to 113°F)  
Storage Humidity: 10% to 90%, non-condensing

## Cleaning

- Dust the set by wiping the screen and the cabinet with a soft, clean cloth or some special liquid cleaner.
- Do not apply excessive force to the screen when cleaning.
- Do not use water or other chemical cleaner to clean the screen as this may damage the surface of the TV screen.

## Hanging the TV Set on the Wall

**Warning: This operation requires two people.**

To ensure a safe installation, observe the following safety notes:

- Check that the wall can support the weight of the TV set and wall mount assembly.
- Follow the mounting instructions provided with the wall mount.
- The TV set must be installed on a vertical wall.
- Make sure to use only screws suitable for the material of the wall.
- Make sure that the TV set cables are placed so that there is no danger of tripping over them.

All other safety instructions about our TV sets are also applicable here. Wall mount bracket not included.

*(Note: Certain TV models are not designed to be mounted to the wall.)*

## TV Buttons

If the batteries in your remote control are run down, you can use the buttons on your TV set. They have the following functions:

For models with below buttons on the set:



For models with below buttons on the set:

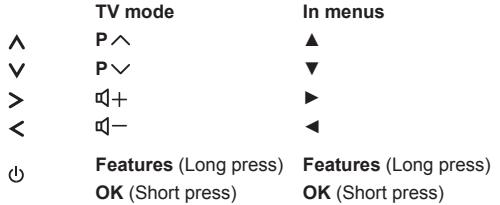

For models with only one button on the set:

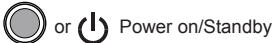

**Note:**

Figures and illustrations are provided for reference only and may vary depending on the model.

## Initial Setup

The first time you switch the set on, the **Welcome** screen appears, which guides you through the initial setup process. Follow the on-screen instructions to finish the initial setup process such as selecting the language, connecting to the network, scanning channels, and more. During each step, either make a choice or skip the step. If you skip a step, you can perform the setup later from the settings menu.

*Note: If the channel search retrieved only the analogue channels it could be caused by poor broadcasting and therefore is not covered by manufacturer warranty. Manufacturers cannot be held responsible for lack of or poor broadcasting in some areas.*

### Google setup and TCL initial setup

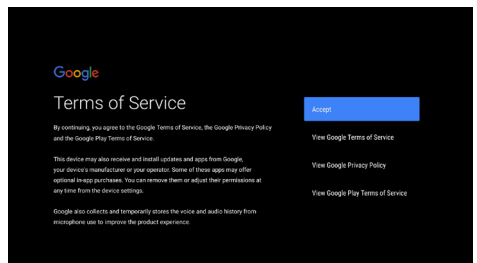
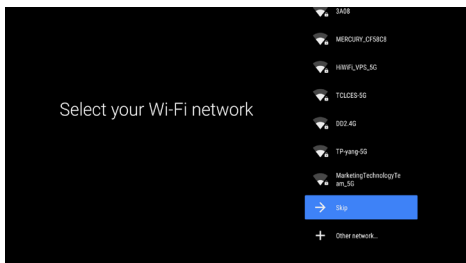
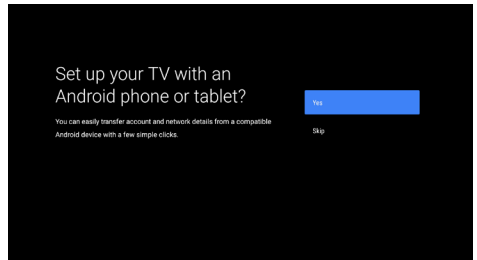
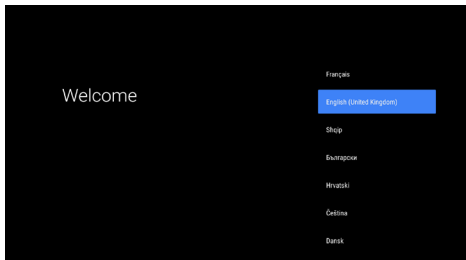

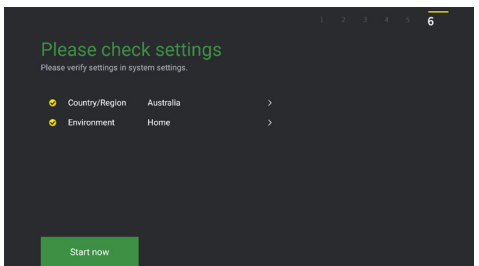
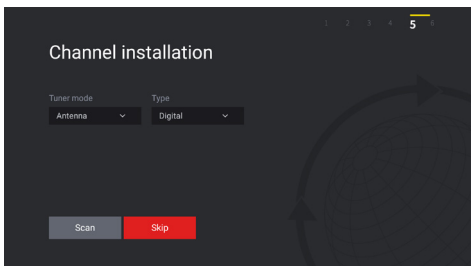
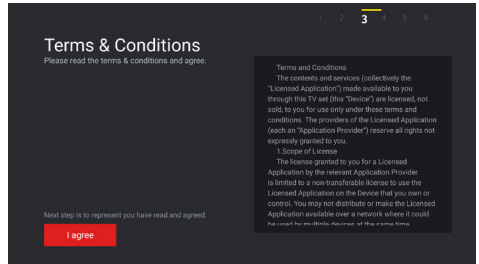
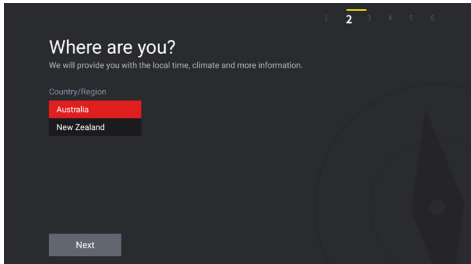
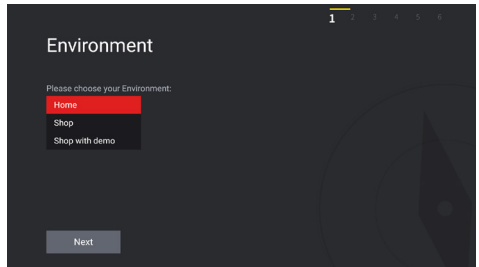
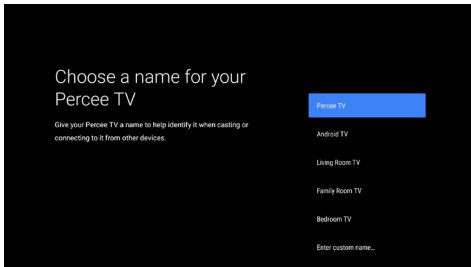
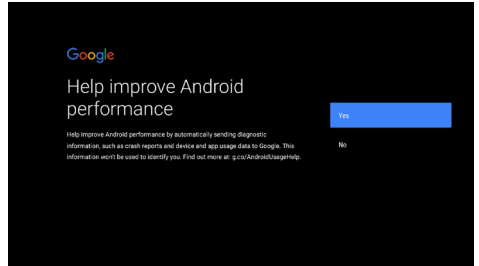
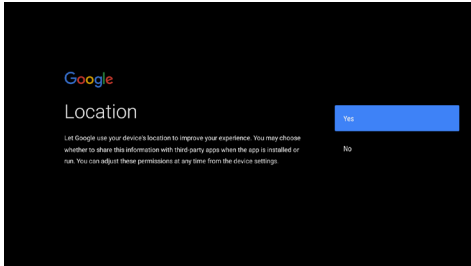

**Note:** Figures and illustrations are provided for reference only and may differ from actual product appearance.

# Connections and Setup

## Sockets

*Note: The location and names of the sockets on the TV may vary according to TV model, and not all sockets are available on all models.*

USB 3.0 or  
USB 2.0 or  
USB 2.0  
/SERVICE

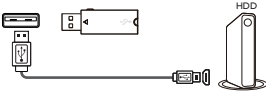

### USB 3.0 or USB2.0 or USB 2.0/SERVICE socket (input)

These sockets can be used to connect a USB device.

**Note:** The number of USB sockets on the TV may vary according to TV model.

HDMI  
or  
HDMI  
(ARC)

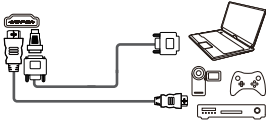

### HDMI or HDMI(ARC) socket (input)

The HDMI (High-Definition Multimedia Interface) socket can be used to connect a Blu-ray player, PC with a compatible video card installed, certain DVD players or a high-definition compatible digital satellite decoder. This socket provides an uncompressed digital connection that carries both video and audio data by way of an integrated mini-jug cable.

COMPONENT IN  
(YPbPr)

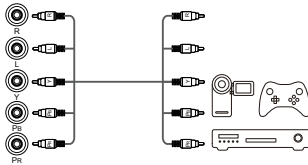

### COMPONENT IN(YPbPr) socket (input)

These YPbPr sockets can be used to connect a device that has component video sockets, such as a DVD player. The component sockets can recognize if the device you're connecting to is Y Pb Pr compatible. The component sockets provide excellent picture quality because the video is separated into three independent parts.

AV IN

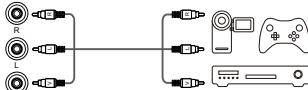

### AV IN adapter socket

The AV IN adapter socket can be used to connect the attached AV adapter cable with VIDEO and AUDIO L & R IN sockets. The AV IN sockets can be used to connect a range of equipment, including video recorders, camcorders, decoders, satellite receivers, DVD players, or games consoles. The VIDEO IN socket provides composite video connection.

or  
AV IN  
adapter

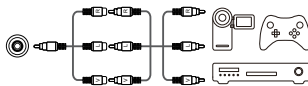

ANTENNA IN

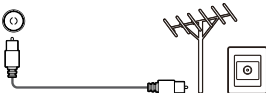

### ANTENNA IN socket (input)

This socket can be used to connect an outside aerial.

LAN



### LAN

RJ45 plug for connecting to external modem or network access equipment.

SPDIF

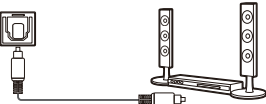

### SPDIF socket (output)

The SPDIF socket can be used to connect a compatible digital audio receiver.



### Headphone socket (output)

This socket can be used to connect headphones or stereo earphones.

**Warning:** Excessive sound pressure from earphones and headphones can cause hearing loss.

## Remote Control Functions

Most of your television's functions are available via the menus that appear on the screen. The remote control supplied with your set can be used to navigate through the menus and to configure all the general settings.

**Note:** Figures and illustrations in this operation manual are provided for reference only and may differ from actual product appearance.

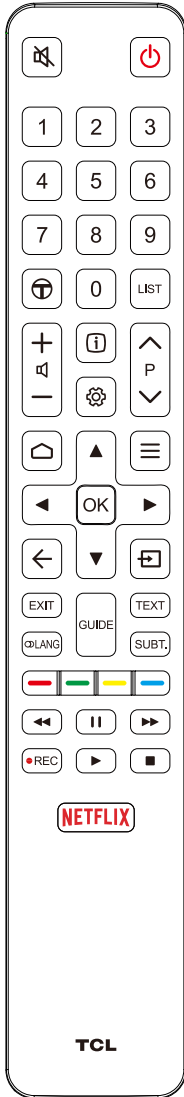

- To switch the sound off and back on.
- Standby / quit standby.
- Numeric buttons** To enter channel numbers or a digit.
- To access T recommended apps.
- LIST** To display the channel list.
- To control the volume.
- To display program information, if available.
- To display the Settings menu.
- P** To change channels.
- To access or exit the Smart TV homepage.
- To display the Option menu.
- Navigation direction buttons.
- OK** To confirm an entry or selection.
- To return to the previous menu or quit an app.
- To select input source.
- EXIT** To exit the Settings menu.
- LANG** To select an audio language available for selected digital TV program.
- GUIDE** To toggle the Electronic Program Guide on or off (only available for digital channels).
- TEXT** To toggle Teletext on or off.
- SUBT.** To select a subtitle language available for selected digital TV program.
- Colour buttons** To select tasks or Teletext pages; to be used for HbbTV function.
- To start fast reverse.
- To pause playback.
- To start fast forward.
- To record programs under DTV source.
- To start playback.
- To stop playback.
- NETFLIX** To access the NETFLIX application. (Not available for some models.)

### Installing Batteries

1. Push to open the back cover as illustrated.
2. Insert two AAA batteries according to the polarities marked on the battery case.
3. Replace the back cover as illustrated.

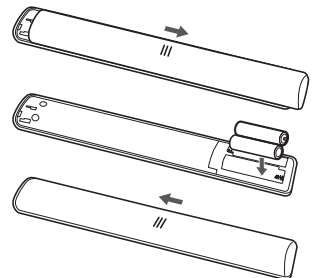

# Connections and Setup

## Exclusive Remote Control



- To switch the sound off and back on.
- Standby / quit standby.
- To control the volume.
- To access T recommended apps.
- To turn on the mouse function.
- To change channels.
- To access or exit the Smart TV homepage.
- To select input source.
- Navigation direction buttons.
- OK** To confirm an entry or selection.
- To return to the previous menu or quit an app.
- To display the Option menu.
- NETFLIX** To access Netflix.
- To pop up the virtual remote control keyboard when available.
- Google Assistant** Press to activate and use Google Assistant. *(Available only when the network connection works normally.)*

Google is a trademark of Google LLC.

**Note:** This remote control is available only for selected models. The remote control type may be changed without notice.

### How to Use the Remote Control

When using or button for the first time, you will be prompted to pair the remote with the TV. Please follow the on-screen guide for pairing instructions.

- a. Keep the remote control and TV in 1 meter, press **OK** and button on the remote at the same time. You can use or button after activating successfully.
- b. This voice search function is only available for content search from certain apps.
- c. Set languages in the **settings** to your local language or official language to enhance voice search successfully.

### Installing Batteries

1. Hold the bottom part of the remote control, use a plastic coin-shaped object to twist the switch to the "Open" location as illustrated.
2. Pull out the battery cover.
3. Insert two AAA batteries according to the polarities marked on the battery case.
4. Replace the battery cover and use a plastic coin-shaped object to twist the switch to the "Close" location.

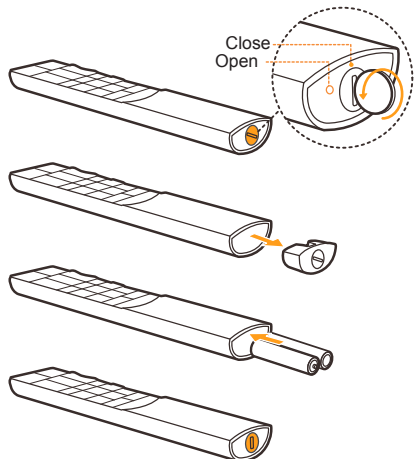



## Network Connection



Your TV will require an internet connection to operate all functions. Data usage charges may apply. Please refer to your Internet Service Provider (ISP) for additional information.

To access the internet, you must subscribe to high speed broadband internet service from your internet service provider.

Your TV can be connected to your home network in two ways:

- Wired, using the RJ45 (LAN) connector on the back panel.
- Wireless, using the internal wireless or external wireless USB adapter and your home wireless network.

**Note:** The following instructions are just the usual ways to connect your TV to the wired or wireless network. The connection method may be different depending on your actual network configuration. If you have any questions about your home network, please refer to your ISP (Internet Service Provider).

### Connecting to a wired network

To connect to a wired network:

1. Ensure you have:
  - An Ethernet cable long enough to reach your TV
  - A router or modem with an available Ethernet port
  - A high-speed internet connection
  - An **Ethernet (LAN) port** on the back of the TV
2. Connect your Ethernet cable to the router and to the **Ethernet port** on the back of the TV.
3. Use the **Network** menu to configure the TV.

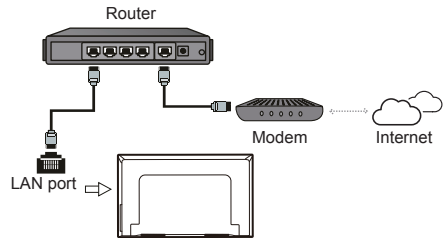





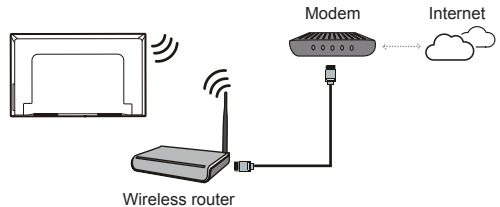

### Connecting to a wireless network

To connect to a wireless network:

1. Ensure you have:
  - A router broadcasting a high-speed wireless signal
  - A high-speed internet connection
2. Use the **Network** menu to configure the TV.



**Note:** Please follow below steps to enter the **Network** menu.

1. Press  on the remote control to display the Smart TV homepage.
2. Press  /  /  to move the cursor to  (**Settings**) on the right top of the screen and press **OK** to enter.
3. Press  /  to select **Network**, then press **OK** to enter the submenu and follow the on-screen guidance to set up your network.

# Connections and Setup

## Switching On

Follow the instructions on this page on how to switch on your TV set and the remote control before going on to following pages describing how to use the channel set-up procedure.

1. Insert two AAA batteries in the remote control.

Precautions on using batteries:

- Only use the battery types specified.
- Make sure you use the correct polarity.
- Do not mix new and used batteries.
- Do not use rechargeable batteries.
- Do not expose batteries to excessive heat such as sunshine, fire or the like, throw them in a fire, recharge them or try to open them, as this could cause them to leak or explode.
- Remove the batteries from the remote control if you are not using it for a long period of time.
- Attention should be drawn to the environmental aspects of battery disposal.

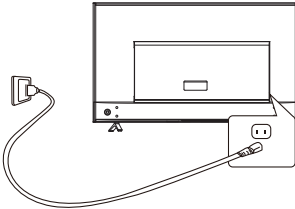

2. Connect the power cable FIRST to the television, THEN to a mains socket. (**Note:** If the power cable is connected to the television, please only connect the power cable to the mains socket.)

Your TV set should only be connected to an AC supply. It must not be connected to a DC supply. If the plug is detached from the cable, do not, under any circumstances, connect it to a mains socket, as there is a risk of electric shock.

**Note:** The figures are for representation only, the location of power socket of the television might differ depend on the model.

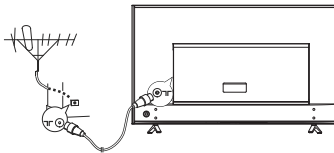

3. Connect an outside aerial to the ANTENNA IN socket at the back of the TV set.

The aerial socket (75 OHM - VHF / UHF / cable) can be used for connecting an external aerial or other equipment fitted.

**Note:** If you want to receive the signal from your cable or cable box, please connect a coaxial cable to the ANTENNA IN socket at the back of the TV set.

4. When powered on, the TV will be turned on directly or be in standby mode.

If the power indicator lights up, the TV set is in standby mode. Press the  button on the remote control or on the TV set to turn on the TV.

## Switching Off

To put the TV set into standby mode, press the  button on the remote control. The TV set remains powered up, but with low energy consumption.

To switch off the TV set, unplug the mains socket from the mains outlet.

## Accessing Channels



**Using the numeric buttons:** press the corresponding numeric buttons on the remote control to access the channels.

**Using the P/V buttons:** press the P/V buttons on the remote control or the corresponding buttons on the TV set to scroll through the channels.

**Using the LIST button:** press the LIST button on the remote control to display the channel list and press ▲/▼/◀/▶ and OK to select channels.



## Watching Connected Devices

Press  on the remote control to display the source list. Press ▲/▼ to select TV or other input sources and press OK to confirm.

You can also press  on the remote control to display the homepage, press ▲/◀/▶ to move the cursor to the  (Inputs) area on the right top of the screen, and press OK to enter. Then press ▲/▼ and OK to select the input source.

## Adjusting Volume

**Volume control:** press the  buttons on the remote control or the corresponding buttons on the TV set to increase or decrease the volume.

**Sound mute:** press the  button to temporarily mute the sound. Press this button again or the  button to restore the sound.

## Accessing Smart TV Homepage

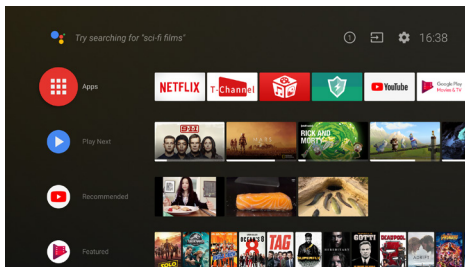

Allows you to enjoy Internet Applications (Apps) and specially adapted Internet websites, and perform system settings for your TV. You can make controlling with the TV remote control.



### WARNING:

- Configure the network settings before using **Smart TV applications**.
- Slow responses and/or interruptions may occur, depending on your network conditions.
- If you experience a problem using an application, please contact the content provider.

- According to circumstances of the content provider, an application's updates or the application itself may be discontinued.
- Depending on your country's regulations, some applications may have limited service or not be supported.
- Changes in application content may be made without prior notice by the service provider.

1. Press  on the remote control to display the Smart TV homepage.
2. Press ▲/▼/◀/▶ and OK to enter the desired apps, functions or settings.
3. Press ← to return to the homepage.
4. To exit the homepage, press ▲/◀/▶ to move the cursor to the  (Inputs) area on the right top of the screen, press OK to enter and then press ▲/▼ and OK to select your desired input source.

**Note:** Since the connection with Internet takes time, it's recommended that you wait a few minutes to use the Smart TV feature after activation of TV from standby.

## Accessing T recommended

Allows you to enjoy Internet Applications (Apps).

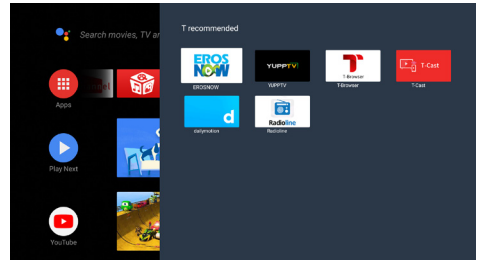

1. Press  on the remote control to display the recommended apps.
2. Press ▲/▼/◀/▶ and OK to enter the desired apps.
3. Press ← to return to the recommend page and exit.

## Accessing Google Play

Google Play is your entertainment unbound. It brings together all of the entertainment you love and helps you explore it in new ways, anytime, anywhere. We've brought the magic of Google to music, movies, TV, books, magazines, apps and games, so you get more from your content every day.

# Basic TV Operations

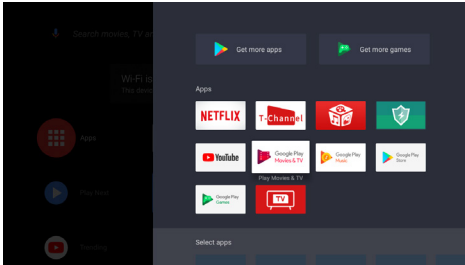

1. Press **HOME** on the remote control to display the Smart TV homepage.
2. Press **▲/▼** to select the **Apps**, and press **OK** to enter. Then press **▲/▼/◀/▶** and **OK** to enter the desired apps.
3. Press **←** to return to the homepage.

## Using System Settings menu

Allows you to not only adjust device settings, such as Network, Inputs, Google Cast, Power and Apps, etc., but also set preferences.

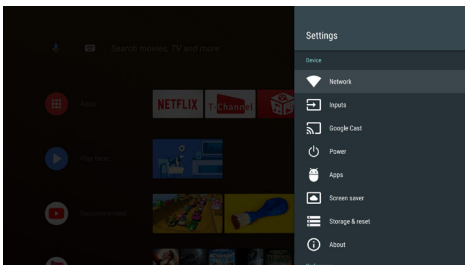
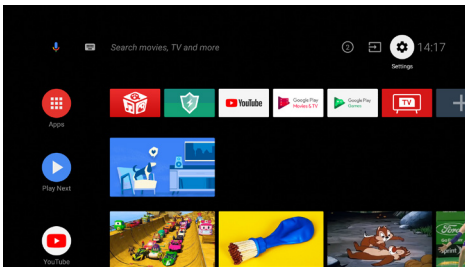

1. Press **HOME** on the remote control to display the Smart TV homepage.
2. Press **▲/▼/◀/▶** to select **Settings** and press **OK** to enter the Google settings.

3. Press **▲/▼** to choose the items and press **OK** to enter.
4. Press **←** to return to previous interface.
5. Press **EXIT** to close the menu.

## Using Instant Power On

It enables you to turn on your TV faster from standby mode than turning this function off, but it will also increase standby power consumption.

1. Press **HOME** on the remote control to display the homepage, Press **▲/▼/◀/▶** to select **Settings > Device > Power > Instant power on** and press **OK** to toggle between **On** and **Off**.
2. Press **←** to return to the homepage.

## Using TV Settings menu

Allows you to adjust TV settings, such as picture and sound.

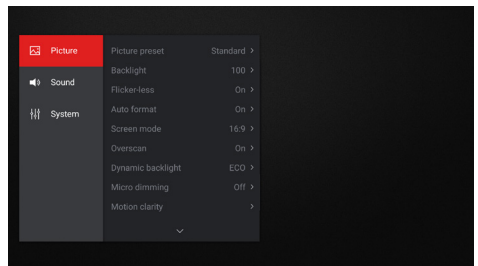



1. Press **SETTINGS** on the remote control to display the Settings menu.
2. Press **▲/▼** to select the desired item, then press **OK/▶** to enter the corresponding submenu.
3. In submenus, press **▲/▼** to select menu options, then press **OK/▶** to enter the option list, the adjustment interface, or the corresponding submenu.
4. Press **←** to return to the previous menu.
5. Press **EXIT** or **SETTINGS** to close the menu.

**Note:** You can also press **≡** on the remote control, select **Settings** (if available) and press **OK** to enter the Settings menu. Some options may not be available for certain signal sources.

## Installing Channels



This section describes how to search and store channels automatically. This may be done in any of the cases below:

- you have skipped the channel installation step in the initial setup;
  - you are prompted that there are no channels in TV mode;
  - you want to update your channels.
1. In TV mode, press  on the remote control and select **Channel > Channel scan**. Press **OK/▶** to enter.
  2. The TV installs and arranges channels according to your country or region. Press **▲/▼** to select **Country/Region**, and press **OK/▶** to enter. Enter the default password **1234** or your own password in case you have changed the password in the **System > Lock menu**. Press **▲/▼** to select your country or region and press **OK** to confirm.
  3. Press **▲/▼** to select **Automatic search** and press **OK/▶** to enter.
  4. Press **▲/▼** to select **Channel type** and press **◀/▶** to select **Digital**, **Analogue** or **Digital&Analogue**.
  5. After configuration is completed, press **▼** to select **Search** and press **OK** to start scanning channels.
  6. The channel search may take a few minutes. After the automatic search, channels are arranged in a preset order. If you wish to hide or move channels, press  on the remote control, select **Channel > Channel organizer** and press **OK/▶** to enter.

## Using Subtitles

You can enable subtitles for each TV channel. Subtitles are broadcast via Teletext or DVB-T digital broadcasts. With digital broadcasts, you have the additional option of selecting a preferred subtitle language.

### Turning on/off subtitles

1. Press  on the remote control, select **Channel > Subtitle** and press **OK/▶** to enter.
2. Select the **Subtitle** option, press **OK/▶** to enter, press **▲/▼** to select **On** or **Off** and press **OK** to confirm.
3. Press **EXIT** or  to close the menu.



### Enabling subtitle languages on digital TV channels

1. Press  on the remote control, select **Channel > Subtitle > Digital subtitle language 1st** and press **OK/▶** to enter.
2. Press **▲/▼** to select a subtitle language as your preferred language and press **OK** to confirm.
3. Press **▲/▼** to select **Digital subtitle language 2nd** and press **OK/▶** to enter.

4. Press **▲/▼** to select a secondary subtitle language and press **OK** to confirm.
5. Press **EXIT** or  to close the menu.



**Shortcut operation:** Press **SUBT.** on the remote control to directly select a subtitle language available for the selected digital TV program.

### Selecting a subtitle type on digital TV channels

1. Press  on the remote control, select **Channel > Subtitle > Subtitle type** and press **OK/▶** to enter.
2. Press **▲/▼** to select a subtitle type and press **OK** to confirm. You can select **Hearing impaired** to display the hearing impaired subtitles with your selected language.
3. Press **EXIT** or  to close the menu.



## Using Teletext

### Selecting decoding page language

1. Press  on the remote control, select **Channel > Teletext > Decoding page language** and press **OK/▶** to enter.
2. Press **▲/▼** to select a proper type of language in which Teletext will display and press **OK** to confirm.
3. Press **EXIT** or  to close the menu.

### Digital Teletext language

On digital TV channels, depending on the broadcaster, you may be able to enjoy a service with multiple initial Teletext pages in different languages. This function allows you to select an available language as primary language, which relates to different initial Teletext pages.

1. Press  on the remote control, select **Channel > Teletext > Digital teletext language** and press **OK/▶** to enter.
2. Press **▲/▼** to select a language and press **OK** to confirm.
3. Press **EXIT** or  to close the menu.

## Network waking up

This function allows you to turn on your TV from standby mode via a network. To use this function, please make sure:

1. Your TV is connected to an effective home network;
2. The desired controller, such as a smartphone, is connected to the same network as your TV;
3. An app which supports network waking up function, has been installed into the controller;
4. **Networked standby** is set to **On** in the **Network** menu.



When the TV is in networked standby mode, you can use the app to wake up the TV remotely.

# Using more of your TV

## T-Link

Use this function to search for CEC devices connected to the HDMI sockets in your TV and enable auto power on and auto standby between the TV and CEC devices.

### Enabling or disabling T-Link

1. Press  on the remote control, select **System > T-Link** and press **OK/▶** to enter.
2. Press **▲/▼** to select **On** or **Off** and press **OK** to confirm.
3. Press **EXIT** or  to close the menu.

### Using Auto Power on

Enables the TV to automatically power on when you power on a CEC device (e.g. DVD) with the device's remote. Select **On** to enable this function.

### Using Auto Standby



Enables all CEC devices to automatically go to the standby mode when you turn off the TV with the TV remote. Select **On** to enable this function.

*Note: The CEC functions depend on the devices connected and it is possible that some devices may not interoperate correctly when connected to this TV. The user manual or the manufacturer of the problematic devices should be consulted for further information.*

## Time Shift

Allows you to pause, fast forward and rewind live TV, so you don't have to miss any part of your favourite programs. Before you use the function, connect a USB drive to the TV first. For the first time, you should complete the disk setup for the USB drive.

*Note: The option is available only when Time Shift is set to On.*

1. Press  on the remote control and select **Time Shift**, then press **OK/▶** to confirm.
2. Follow the directions on the screen to do the disk setup if you use time shift for the first time.
3. After the disk setup is done, time shift will start, and the time shift menu displays on the screen. For later use, press  and select **Time Shift**. press **OK/▶** to display the time shift menu and operate according to the on-screen prompt.
4. Pressing  button stops the time shift and exits.
  - When the time shift menu disappears and only the timing of the time shift remains on the screen, you can press **OK** to call out the time shift menu.

### Notes:

- This feature is available only for digital channels.
- Before you plug the USB drive to TV, make sure you have backed up the data on the drive to avoid unforeseen malfunction and data loss.

- We recommend that you use a USB drive with at least 1GB free space and a disk speed faster than 5.0MB/sec.
- The bigger the USB drive free space for time shift, the bigger the recording length.

**Quick Access of Time Shift:** Insert a USB disk, press **PAUSE (II)** on the remote control, it will access Time Shift automatically.

## HbbTV

HbbTV (Hybrid broadcast broadband TV) is a service offered by certain broadcasters and available only on some digital TV channels. HbbTV delivers interactive television over broadband Internet. These interactive features are added to and enrich the normal digital programs, and include services such as digital teletext, electronic program guide, games, voting, specific information related to the current program, interactive advertising, information magazines, catch-up TV, etc. To use HbbTV please ensure your TV is connected to Internet and HbbTV is switched on.

### Notes:

- HbbTV services are broadcast- or country-dependent and may be unavailable in your area.
- You cannot download files to your TV with HbbTV function.
- Application provider or broadcasting related conditions may cause an HbbTV application to be unavailable momentarily.
- To access HbbTV applications you must connect your TV to the Internet via a broadband link. HbbTV applications may not work correctly in case of network related issues.

### HbbTV access

1. Press  on the remote control, select **System > Advanced settings > HbbTV** and press **OK/▶** to enter.
2. Press **▲/▼** to select **On** and press **OK** to confirm.
3. When you tune to a digital TV channel that offers HbbTV, this will be signaled to you by an on-screen indication (generally a red button, but other colour buttons may also be used). Press the indicated colour button to open the interactive pages.
4. Use **▲/▼/◀/▶** and the colour buttons to navigate through the HbbTV pages and press **OK** to confirm.

### HbbTV deactivation

To avoid disturbances that may be caused by HbbTV broadcasting tests, you can turn off the HbbTV function:

1. Press  on the remote control, select **System > Advanced settings > HbbTV** and press **OK/▶** to enter.
2. Press **▲/▼** to select **Off** and press **OK** to confirm.

# Using more of your TV

## Google Cast

Google Cast™ lets you cast your favorite videos, games, and apps from your mobile device, in full quality, to your TV. Just one tap of the Cast button on your Android or iOS screen is all you need to supersize the things you love. Cast your content then continue browsing on your phone or tablet.

## T-Cast

T-Cast lets you enjoy plenty of videos, rich of applications by scanning the QR code on the TV screen and downloading T-Cast.

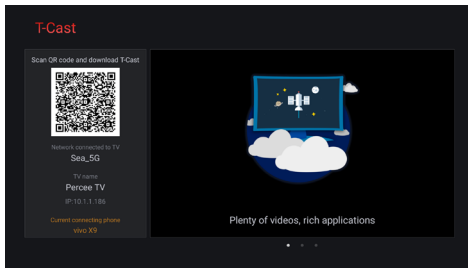

## PVR(Personal Video Recorder)

Allows you to record your favourite TV programs. Before you use the function, connect a USB drive to the TV first.

**Note:** The feature is available only in selected products and, due to specific TV network limitations and country technical requirements, might not be available in product or place of installation. Feature might also be blocked by TV network due to copyright protection (HD content, recording protection). Please use **≡** on the remote control to check if the feature is available in your product.

1. Press **≡** on the remote control and select **PVR**.
2. Press **OK/▶** to enter and select **Record**. It starts to record automatically.
3. Press **BLUE** button on the remote control and use **▲/▼/◀/▶** to adjust the recording duration.
4. Press **OK/■** to stop recording manually, the recorded file will be saved. In normal operation, the recording will stop automatically when the recording duration expires.
5. In recording, the PVR mini pane will also show on the screen to indicate the recording progress.
6. To watch the recorded program, exit PVR mode first, Press **≡** and select **PVR > PVR List**, then select the related record file. Press **OK** to play. (It is the same if you record a digital radio program).

## Notes:

- This feature is available only for digital non-encrypted channels. Even when C/CAM (CI or CI+) is inserted, this feature is not available on encrypted channels.
- Before you connect the USB drive to the TV, make sure you have backed up the data in the drive to avoid the loss of your important data due to unforeseen malfunction.
- The bigger the USB drive free memory for the PVR function, the bigger the recording length.
- If you want to change channel or signal source during recording, store the recording data before changing the channel or source.
- The TV cannot play files normally if the parameters of the file exceed the limitations of the system, the file format is not supported, the file is damaged, or the file cannot be decoded.
- Do not disconnect the USB drive when the system is reading a file or transmitting data, otherwise the system or the drive may be damaged.

## Using EPG (Electronic Program Guide)

EPG is an on-screen guide that displays scheduled digital TV programs. You can navigate, select and view programs.

**Note:** The DTV EPG does not require an internet connection. To use the DTV EPG, HbbTV must be set to **Off**. when HbbTV is set to **ON**, then it will enter the HbbTV EPG directly. Please refer to “**HbbTV**” part of this manual for assistance to set HbbTV to on or off.

1. Press **GUIDE** on the remote control, the **Program Guide** menu will appear, which allows you to get information about the current or next program playing on each channel. Navigate through the different programs using the **▲/▼/◀/▶** buttons on the remote control.
2. Use the related buttons shown at the bottom of the screen to view EPG.
  - **Program filter:** Program guide filter for digital TV programs.
    - Press **≡** to display the type list of the program.
    - Navigate through the different types using the **▲/▼** buttons on the remote control.
    - Select one or more types, which you want to highlight from the type list, press **OK** to select or deselect. A checkmark will appear to the right of the type when selected.
  - **Custom schedule:** Press **▲/▼** to select a program, then press the **RED** button to set the schedule. Use the **▲/▼** buttons to select **Schedule reminder** or **Schedule recording**, then press **OK** to enter.

# Using more of your TV

- **Select date:** Press the **GREEN** button to select date.
  - **Schedule list:** Press the **YELLOW** button to view your schedule list.
3. Press **GUIDE** or **EXIT** to exit EPG.

## Bluetooth Function

(\* not available for some models)

Bluetooth® is a wireless technology standard for exchanging data over short distance between Bluetooth devices. You can connect Bluetooth audio device, mouse or keyboard via the TV.

1. Press  on the remote control, move to the **Settings** area, select **Settings** and press **OK** to enter.
2. Move to the **Remote & accessories** area, select **Add accessory** and press **OK** to enter. The TV will search nearby Bluetooth devices automatically.
3. Select an available device, press **OK** and follow the guides on the screen to connect it.

**Note:** Bluetooth technology (if available in your TV) uses 2.4GHz frequency thus close proximity to WiFi access points, routers or microwave ovens might interfere with Bluetooth audio streaming. If you face interruptions in audio reception, you should restart your Bluetooth device to find frequency with less interferences and if you continue to face issues you should move closer to TV or increase space between TV and source of interferences.

The Bluetooth word mark and logos are registered trademarks owned by Bluetooth SIG, Inc. and any use of such marks by TCL is under license. Other trademarks and trade names are those of their respective owners.

## Freeview Plus

Freeview Plus is a new television service which provides a state of the art EPG and seamless access to Catch Up TV from free-to-air networks with the simple press of a button. Freeview Plus provides an unrivalled user experience and places free to air television at the forefront of innovation, with services that include:

- A 7-day, easy-to-use EPG
- All available Catch Up TV on the TV screen
- Featured recommendations
- Ability to browse by genre and search programs for the next 7 days
- A favourite function with reminders for live and Catch Up programs

### What you need

You need a high-speed (broadband) internet connection to the TV.

### To launch Freeview Plus

When you are watching TV, you will briefly see a prompt at the top left of the screen. Press the corresponding colour key on the remote control to launch Freeview Plus. Follow the on-screen instructions and use the colour keys, arrow keys, and **OK** button to navigate.

\*Freeview Plus uses HbbTV technology which combines broadcast and broadband. Internet connection is required. Data usage and conditions apply.

\*\*Freeview Plus is available through out Australia but Catch Up services vary by region – please check [www.freeview.com.au](http://www.freeview.com.au) to see what's available in your area.

\*\*\*More information about Freeview Plus can be found on [www.freeview.com.au](http://www.freeview.com.au).

### Netflix settings

Netflix provides on-demand movies and TV shows delivered via the Internet. Netflix is available in certain countries. Unlimited membership is required. More information can be found at [www.netflix.com](http://www.netflix.com) <<http://www.netflix.com/>> .

*Note: you can directly access Netflix via clicking the **Netflix** button on the remote control.*

### Password in Parental Control

- The default password is 1234. You can change it to a new one.
- The super password is 0423. If you forget your code, enter the super password to override any existing codes.



## Problems & Solutions

*Note: Problems & solutions 1 to 2 are for the TV models which have network functions, so users of non-connected TV models can disregard them.*

### 1. Fail to link to the network.

- Check if your TV is connected with the network;
- Reboot your TV;
- Consult your internet service provider, to confirm if access of your router is supported. Refer to the operation manual of your router.
- Make sure your TV is connected to a router, and make sure your router is powered on. Check that your router/modem has an internet connection, and that your Ethernet cables/wireless connection is OK. Test your connection with a computer to make sure it is OK. Should the problem persist, contact customer service.

### 2. The video could not be played smoothly.

- Videos from your USB flash drive --- It may result from data transmission, or its code flow is far beyond the supported formats of this TV set.
- Videos downloaded from internet, or online videos.
  - a. It may be caused by the lower bandwidth of your network. A high network speed is required to handle online videos.
  - b. Peak internet usage times may affect the bandwidth.
  - c. Check if any other computers on the same network are also operating, as they may be using up bandwidth. Especially if they are downloading or playing on-line videos.
  - d. The video may not be smooth itself, it is not the problem of your TV or network.

### 3. When two mobile hard disks are connected with the TV at the same time, they will not be recognized some times.

- All mobile hard disks consume a lot of power, which may result in power supply problems. We recommend inserting only one hard disk, or a low power consumption mobile hard disk.

### 4. The video from a mobile hard disk (USB) is playing with no sound.

- The audio format of the video in your mobile hard disk is not supported by the TV player.

### 5. Some videos fail to play.

- The formats of the videos may not be supported by the TV, especially videos shot by certain kinds of cameras, generally with their private protocol of formats, which are not compatible with your TV.

### 6. Video stops playing midway.

- Mistakes may occur when videos are copied or

compressed, so they may automatically stop playing during playback.

### 7. What should I pay attention to, when I do SW updating?

- No power cuts when SW updating;
- Avoid any operations with your remote control when SW updating;
- Depending on your internet connection speed, the software updating process may take some time.

### 8. There are no distinct changes of TV interface after SW updating.

- Under certain conditions, SW updating may not only update or add new functions but also improve the performance of the TV set, without distinct changes to the user interface. Also, there may be no changes to the user interface at all.

### 9. What should I do when SW updating process stops due to a sudden power-off?

- If you do SW updating by USB, do not pluck the USB from your TV, and restart your TV to continue SW updating; If you do SW updating by Network, also restart your TV and check if it is well functioned.

### 10. With a USB device being inserted into the TV in advance, I am prompted that no USB devices are detected after I access Media, why?

- There may be something wrong with your mobile hard disk(s), damaged or with low voltage. You could increase power supply by inserting the two plugs on one end on the USB wire into TV's USB port simultaneously.

### 11. External device cannot be recognized.

- Some external devices (e.g. webcam, smart phone, tablet, game handle, and external wireless adapter) may not be compatible with the TV and cannot be supported for certain functions (nScreen, wireless display, gesture control, face recognition, if any). Please try a similar device. If it does not work, contact your local dealer.

### 12. Voice search does not work.

- Check if your remote control has been successfully paired with your TV.
- Check if the language setting is correct.
- Check if Google server is available and stable.

## Troubleshooting

Most problems you encounter with your TV can be corrected by consulting the following troubleshooting list.

### No picture, no sound

1. Check if the fuse or circuit breaker is working.
2. Plug another electrical device into the outlet to make sure it is working or turned on.
3. Power plug is in a bad contact with the outlet.
4. Check the signal source.

### No colour

1. Change the colour system.
2. Adjust the saturation.
3. Try another channel. Black-white program may be received.

### Remote control does not work

1. Change the batteries.
2. Batteries are not installed correctly.
3. Main power is not connected.

### No picture, normal sound

1. Adjust the brightness and contrast.
2. Broadcasting failure may happen.

### Normal picture, no sound

1. Press the VOLUME UP button to increase volume.
2. Volume is set to mute, press the Mute button to restore sound.
3. Change the sound system.
4. Broadcasting failure may happen.

### Unorderly ripples on the picture

It is usually caused by local interference, such as cars, daylight lamps and hair driers. Adjust the antenna to minimize the interference.

### Snowy dots and interference

If the antenna is located in the fringe area of a television signal where the signal is weak, the picture may be marred by dots. When the signal is extremely weak, it may be necessary to install a special antenna to improve

the reception.

1. Adjust the position and orientation of the indoor/outdoor antenna.
2. Check the connection of antenna.
3. Fine tune the channel.
4. Try another channel. Broadcasting failure may happen.

### Ignition

Black spots or horizontal streaks appear, or the picture flutters or drifts. This is usually caused by interference from car ignition system, neon lamps, electric drills, or other electrical appliance.

### Ghost

Ghosts are caused by the television signal following two paths. One is the direct path, the other is reflected from tall buildings, hills, or other objects. Changing the direction or position of the antenna may improve the reception.

### Radio frequency interference

This interference produces moving ripples or diagonal streaks, and in some case, loss of contrast in the picture. Find out and remove the radio interference source.

*\*To bring you better visual experience, please remove all labels, if any, from TV front panel and screen before use.*

*\*Figures and illustrations in this User Manual are provided for reference only and may differ from actual product appearance. Product design and specifications may be changed without notice.*

## Legal Statement

[Legal Statement] of TCL - manufacturer of this TV set  
Due to the various capabilities of products featuring the SmartTV - Services, as well as limitations in the available content, certain features, applications, and services may not be available on all devices or in all territories. Some features on SmartTV may also require additional peripheral devices or membership fees that are sold separately. Please visit our website for more information on specific device information and content availability. The services and availability of content through SmartTV are subject to change from time to time without prior notice.

All content and services accessible through this device belong to third parties and are protected by copyright, patent, trademark and/or other intellectual property laws. Such content and services are provided solely for your personal noncommercial use. You may not use any content or services in a manner that has not been authorized by the content owner or service provider. Without limiting the foregoing, unless expressly authorized by the applicable content owner or service provider, you may not modify, copy, republish, upload, post, transmit, translate, sell, create derivative works, exploit, or distribute in any manner or medium any content or services displayed through this device.

You expressly acknowledge and agree that use of the device is at your sole risk and that the entire risk as to satisfactory quality, performance and accuracy is with you. The device and all third party content and services are provided "as is" without warranty of any kind, either express or implied. TCL expressly disclaims all warranties and conditions with respect to the device and any content and services, either express or implied, including but not limited to, warranties of merchantability, of satisfactory quality, fitness for a particular purpose, of accuracy, of quiet enjoyment, and non-infringement of third party rights. TCL does not guarantee the accuracy, validity, timeliness, legality, or completeness of any content or service made available through this device and does not warrant that the device, content or services will meet your requirements, or that operation of the device or services will be uninterrupted or error-free. Under no circumstances, including negligence, shall TCL be liable, whether in contract or tort, for any direct, indirect, incidental, special or consequential damages, attorney fees, expenses, or any other damages arising out of, or in connection with, any information contained in, or as a result of the use of the device, or any content or service accessed by you or any third party, even if advised of the possibility of such damages.

Third party services may be changed, suspended, removed, terminated or interrupted, or access may be disabled at any time, without notice, and TCL makes no representation or warranty that any content or service will remain available for any period of time. Content and services are transmitted by third parties by means of networks and transmission facilities over which TCL has no control. Without limiting the generality of this disclaimer, TCL expressly disclaims any responsibility or liability for any change, interruption, disabling, removal of or suspension of any content or service made available through this device. TCL may impose limits on the use of or access to certain services or content, in any case and without notice or liability. TCL is neither responsible nor liable for customer service related to the content and services. Any question or request for service relating to the content or services should be made directly to the respective content and service providers.

## Licence



The terms HDMI, HDMI High-Definition Multimedia Interface, and the HDMI Logo are trademarks or registered trademarks of HDMI Licensing Administrator, Inc.



H.265-HIGH EFFICIENCY VIDEO CODING

HEVC, or H.265 is the successor to H.264 and strives to deliver video with equivalent quality with bitrate savings of up to 50 percent. HEVC is critical for streaming high-quality video even in congested network environments, and will be a driving factor in the delivery of 4K content to new Ultra HD displays.



Manufactured under license from Dolby Laboratories. Dolby, Dolby Audio, and the double-D symbol are trademarks of Dolby Laboratories..



The Bluetooth® word mark and logos are registered trademarks owned by Bluetooth SIG, Inc. and any use of such marks by TCL is under license. Other trademarks and trade names are those of their respective owners.



For DTS patents, see <http://patents.dts.com>. Manufactured under license from DTS Licensing Limited. DTS, the Symbol, DTS and the Symbol together, and DTS Premium Sound are registered trademarks or trademarks of DTS, Inc. in the United States and/or other countries. © DTS, Inc. All Rights Reserved.



Freeview Plus uses HbbTV technology which combines broadcast and broadband. Internet connection is required. Data usage charges and conditions apply.



Like us on Facebook

**TCL Electronics Australia Pty Ltd.**

ABN 83 111 032 896

Address: 797 Springvale Road, Mulgrave, VIC 3170, Australia

Telephone: 1300 738 149

[service.au@tcl.com](mailto:service.au@tcl.com)

[www.tclelectronics.com.au](http://www.tclelectronics.com.au)

72-MT58DU-EAU1E