

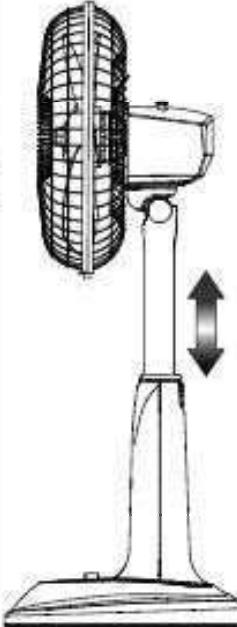
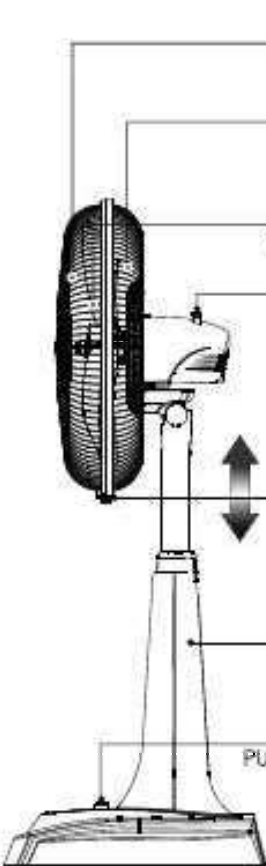
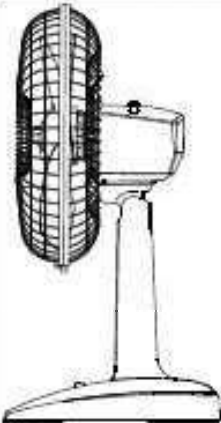

座檯電風扇 ELECTRIC DESK FAN

零部件名稱 / PART NAME		
型號 / MODEL		
D12-G□/G□-P	R16-G□/G□-P	R18-G□/G□-P
		 <p>前護罩 FRONT GUARD</p> <p>後護罩 BACK GUARD</p> <p>扇葉 PROPELLER FAN</p> <p>KNOB K</p> <p>護罩夾 GUARD CLIP</p> <p>支架 STAND</p> <p>風速鍵 PUSH BUTTON SWITCH</p>
<p>D16-G□/G□-P</p> 		

REMARK: □ IS THE ALPHABET OF PRODUCTION YEAR

安裝及操作前請先細閱本說明書，以確保安全。
FOR SAFETY, PLEASE READ THIS MANUAL PRIOR TO INSTALL AND OPERATING

組裝零部件 / HOW TO ASSEMBLE

護罩及扇葉組裝程序 (見附圖)。
Process of assemble the guard and propeller fan. (referring to the below figures)

組裝前 / Before assemble:

- 拆下旋鈕及螺帽
- Remove the spinner and the back guard lock



把橫栓對準插槽 插槽
Align the pin and the groove.

插槽 GROOVE

橫栓 PIN

方並扣上 Guide 標誌 Mark
裝上後護罩時，對準有標誌的地
Align GUIDE and MARK

前護罩 FRONT GUARD

① 對準護罩上的標記，然後把前護罩套上。
Align with the mark on the back guard and hang on.

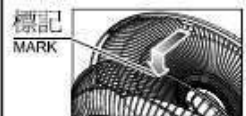

② 同時使用雙手把前護罩完全套上。
Use both hands to fit into place.



③ 扣上護罩夾扣
Lock guard clip

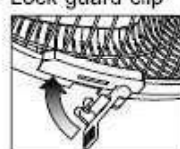

馬達回轉軸 ROTOR SHAFT 螺帽 BACK GUARD LOCK 旋鈕 SPINNER

支架 STAND 後護罩 BACK GUARD 扇葉 PROPELLER FAN 護罩夾 GUARD CLIP

Model R18-G

此箭嚮“上”
This mark is up.

組裝前 / Before assemble:

- 拆下旋鈕及螺帽
- Remove the spinner and the back guard lock



把橫栓對準插槽 插槽
Align the pin and the groove.

插槽 GROOVE

橫栓 PIN

前護罩 FRONT GUARD

護罩夾 GUARD CLIP

警告 WARNING

禁止使用未完成安裝底座的電風扇 (電風扇可塌下並造成傷害)
Do not switch on the incomplete electric fan assembly (the fan may collapse and cause injury)

注意 CAUTION

錯誤安裝後護罩，有可能會產生噪音如下：
 ■ 當風扇啟動時，扇葉與螺帽的接觸點，會引起噪音。
 ■ 當風扇啟動時，若安裝不平衡，會引起噪音。
 Incorrectly fastening the back guard lock may cause asymmetrical noise as a consequence of-
 ■ The contact between the propeller and the guard lock which causes noise while fan is operating.
 ■ Misplace of the balance which causes noise while fan is operating.

前護罩 FRONT GUARD

護罩夾 GUARD CLIP

1. 安裝電風扇前，先將附在支架底部的六角螺絲釘鬆出 (見圖1)
 2. 將電線穿過風扇底座的後孔 (見圖2)
 3. 當風扇支架與底座組裝完成後，請將電源線固定在底座的洞孔空間 (見圖3)
 4. 利用在圖1鬆出的六角螺絲釘，將風扇支柱與底座鎖緊 (見圖4)
1. Before installation, unscrew a Hexagon head bolt which attached with bottom of Stand (Fig.①)
 2. Thread power cord through the backside hole of base cover (Fig.②)
 3. After assemble the stand and base cover together, fix the power cord to the retaining hold of base cover (Fig.③)
 4. Re-screw the removed Hexagon head bolt as Fig.① to fit tightly between the stand and the base cover (Fig.④)

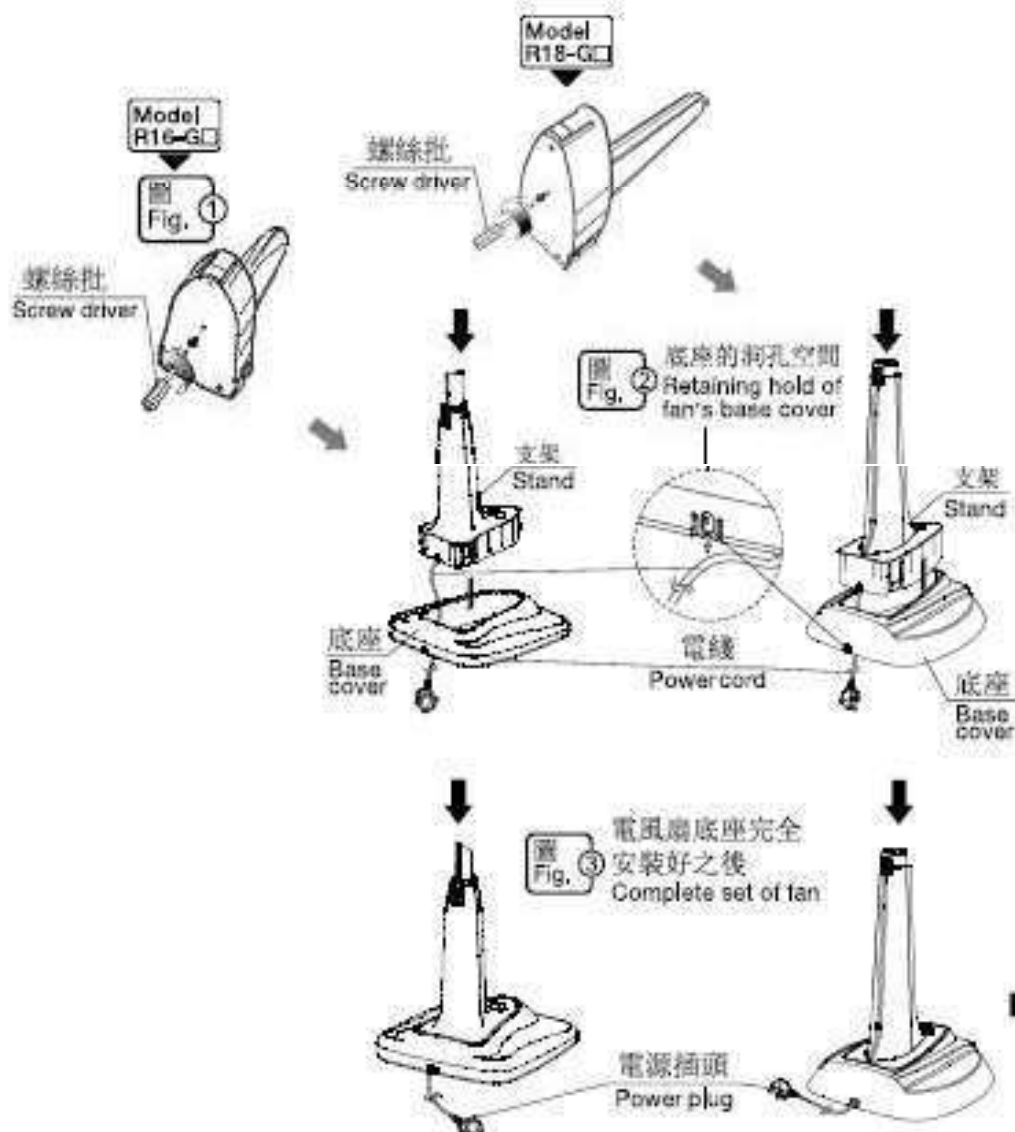

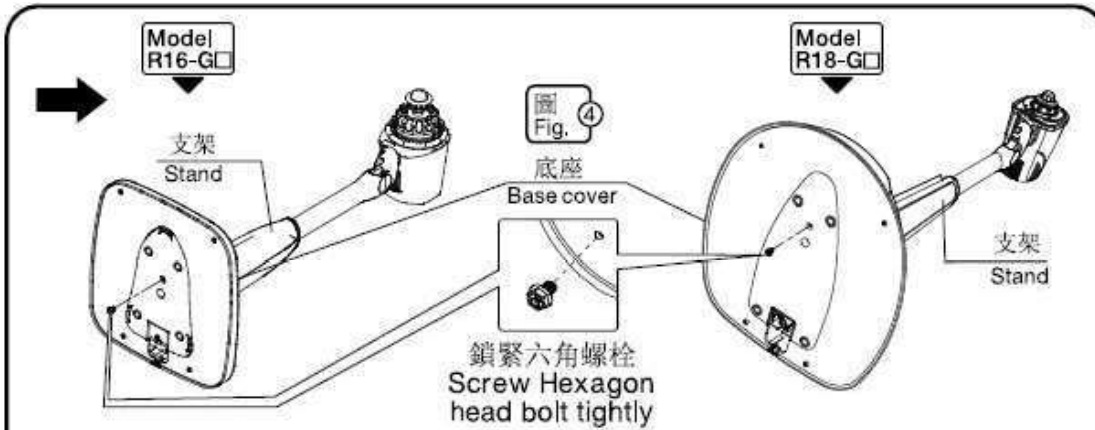

操作方法 / HOW TO USE

風速調節器 / SPEED REGULATOR

- 按下風速控制鍵1、2或3，即可啓動風扇。
關機，按“0”。
最低風速，按“1”。
中度風速，按“2”。
最高風速，按“3”。
- Press one of the three push button switch (1, 2 or 3) to turn the fan on.
Press “0” to turn off.
Press “1” for the lowest fan speed.
Press “2” for the medium fan speed.
Press “3” for the highest fan speed.

搖擺送風 / OSCILLATION

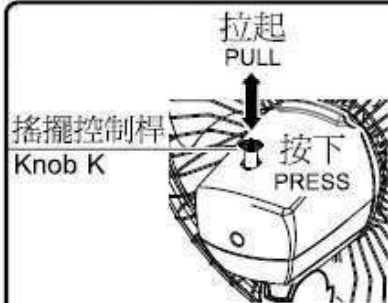

- 按下搖擺控制桿，即可啓動搖擺送風功能。
- 拉起搖擺控制桿，即可停止搖擺送風功能。
- Press Knob K to start fan oscillation.
- Pull Knob K to stop fan oscillation.

風向 / AIR FLOW DIRECTION

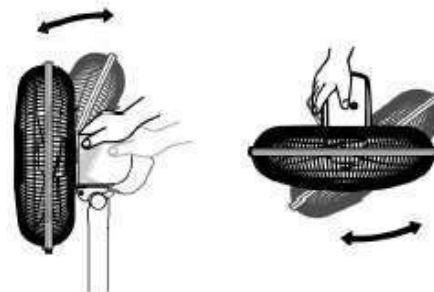

- 本機可供向上、下、左、右調校風向。調校時，只需輕握支架，把馬達調校到所需方向即可。
- The air flow direction can be adjusted up, down, left or right by gently hold the stand and adjust the motor as desired.

HEIGHT ADJUSTMENT MODEL : R16-G□/G□-P, R18-G□/G□-P

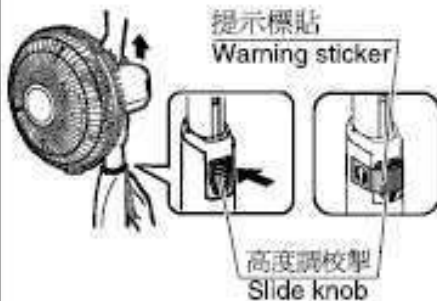

- 要提升風扇高度，按住高度調校掣，把馬達部分拉起至所需高度。
- 要降低風扇高度，按住高度調校掣，把馬達部分降低至所需高度。
- To raise the level of the fan, press the slide knob together with pulling up the motor part to the desired height.
- To lower the level of the fan, press the slide knob together with lowering the motor part to the desired height.



：組裝護罩及扇葉前，請勿按高度調校掣，否則馬達部分迅速滑起可能引致受傷。

： Do not press slide knob unless assemble the guard and propeller fan because the motor part quickly slide up and cause injury.

警告 / CAUTION

- ① 切勿將手指或其他物件放進護罩內，否則可能損害扇葉或引致受傷。

Do not put fingers or anything into the guard. The blade might be damaged and cause injury.



- ② 請勿在下列環境中使用本機：

- 室溫高於 45°C
- 極度潮濕的地方
- 靠近火種或容易被水灑濕的地方
- 存放大量燃油、化學品或滿佈塵埃的地方

Do not use the fan in :

- Room temperature over 45 °C
- Very humid area
- Near fire or wet area
- Area containing high amount of fuel, chemicals or dust.



- ③ 請勿在本機上使用任何噴霧劑，否則塑料零部件可能受損或變形。

Do not apply any kind of spray. Otherwise, the plastic parts might be damaged or deformed.



- ④ 請勿在靠近窗簾的位置使用本機，以免造成損壞或意外。

Do not use the fan near curtain because it can cause damage and accidents.



⑤ 避免將風扇長時間直吹向人體，特別是病人、嬰兒及長者。
It is strongly advised, not to blow the fan wind directly toward body for a long time especially for patient, infant and elderly.



⑥ 若本機電源線受損，不應自行修理，必須送交合資格技術人員或三菱電機維修服務中心修理。
If the supply cord is damaged, it must be replaced by a qualified technician or MITSUBISHI ELECTRIC's Service Centers.



⑦ **電線的注意**

- 請勿弄破電線
- 請勿重力壓在電線上
- 請勿屈曲電線
- 請勿扭緊電線
- 請勿拉緊電線

以上行為也有機會導致短路或火警。

Power cord caution

- Do not make pinched
- Do not make overload on
- Do not bend
- Do not twist
- Do not pull on

It is may cause electric shock, and fire.

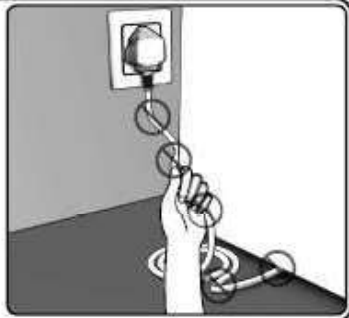

保養須知/CARE INSTRUCTION

1. 在移除保護罩前，必先將電風扇關閉及將電源線拔掉。
 2. 為免發生意外，清潔前請拔除插頭，並避免把通電的零部件沾濕。
 3. 要清潔零部件(例如：扇葉、支架、底座、護罩等)，請用浸過溫水或沾上溫和清潔劑的軟布拭抹，再用軟布抹乾。
 4. 切勿使用揮發性化學品(例如：汽油、苯、稀釋劑、清潔噴霧劑、酒精等)或其他化學品(例如：經化學處理的除塵布、鹼性肥皂液、沸水、清潔劑等)清潔本機，以免損害塑料零部件。
 5. 假如扇葉積聚大量塵埃，或會令馬達因過熱或震動過度而燒毀或損壞，所以請確保扇葉清潔。
 6. 兒童應在成人陪同下使用本機，以確保安全。
 7. 不論本產品是否正在運作，請指導並確保兒童不會把玩本機，避免發生意外。
1. The fan must switch off from supply mains before removing the guard.
 2. To prevent accidents, always unplug the fan before cleaning. Also keep electrical parts out of water.
 3. Clean the dirty parts (propeller fan, stand, base, guard, etc.) by using soft cloth, soaked and damped in warm water or mild detergent then wipe dry with soft cloth.
 4. Do not use volatile chemicals (gasoline, benzene, thinner, spray cleaner, alcohol, etc.) or other chemicals (treated dust cloths, alkaline soap solutions, boiling water, cleaner, etc.) for cleaning because all of these can damage the plastic parts.
 5. If a large amount of dust collects on the propeller fan, it may cause overheating or excessive vibration of the motor. This can lead to burn out and other damages, so be sure to keep the propeller fan clean.
 6. This appliance is not intended for use by persons (including children) with reduced physical, sensory or mental capabilities, or lack of experience and knowledge, unless they have been given supervision or instruction concerning use of the appliance by a person responsible for their safety.
 7. Children should be supervised to ensure that do not play with the appliance.

警告 WARNING

- 不論任何情況，不應對產品進行修改，產品拆卸及維修必須交由專業技術人員負責(以免引起火警、觸電或受傷)。如有疑問，請向三菱電機經銷商或維修服務中心查詢。
- Disassembly and repair should not be done unless carrying by a specialized technician (cause of fire, electric shock and injury). Please consult your MITSUBISHI ELECTRIC dealer or service center.



ELECTRIC DESK FAN
MODEL

R30A-HR□, R30A-HR□-P

INSTRUCTION MANUAL

PART NAME

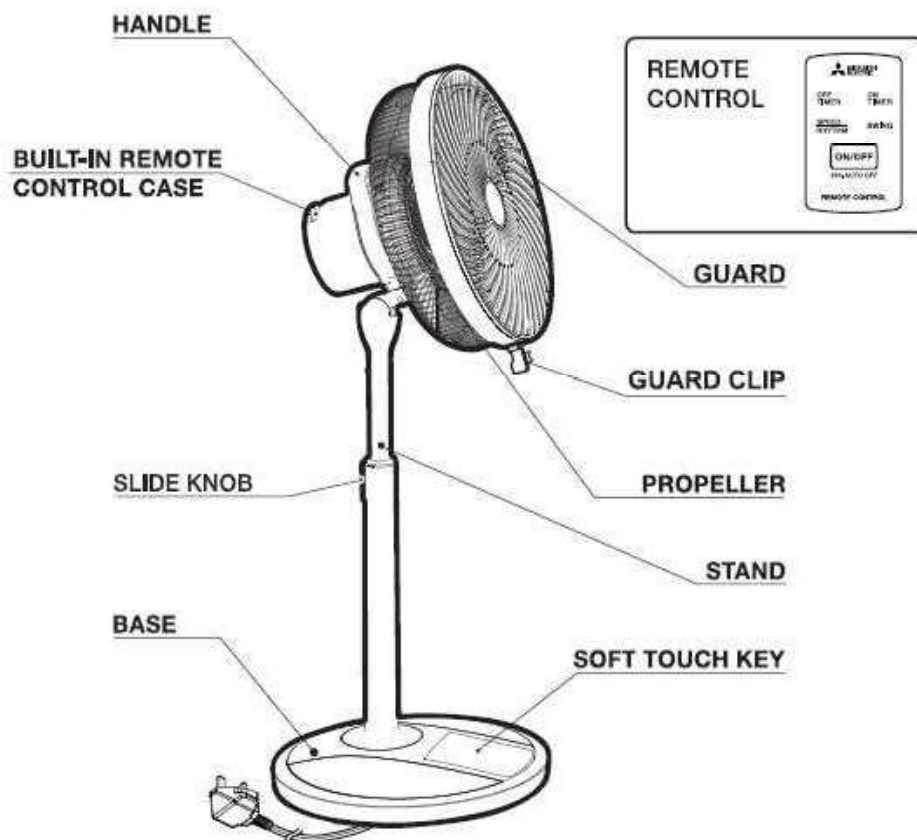

REMARK: □ IS THE ALPHABET OF PRODUCTION YEAR

FOR SAFETY, PLEASE READ THIS MANUAL PRIOR TO INSTALL AND OPERATING

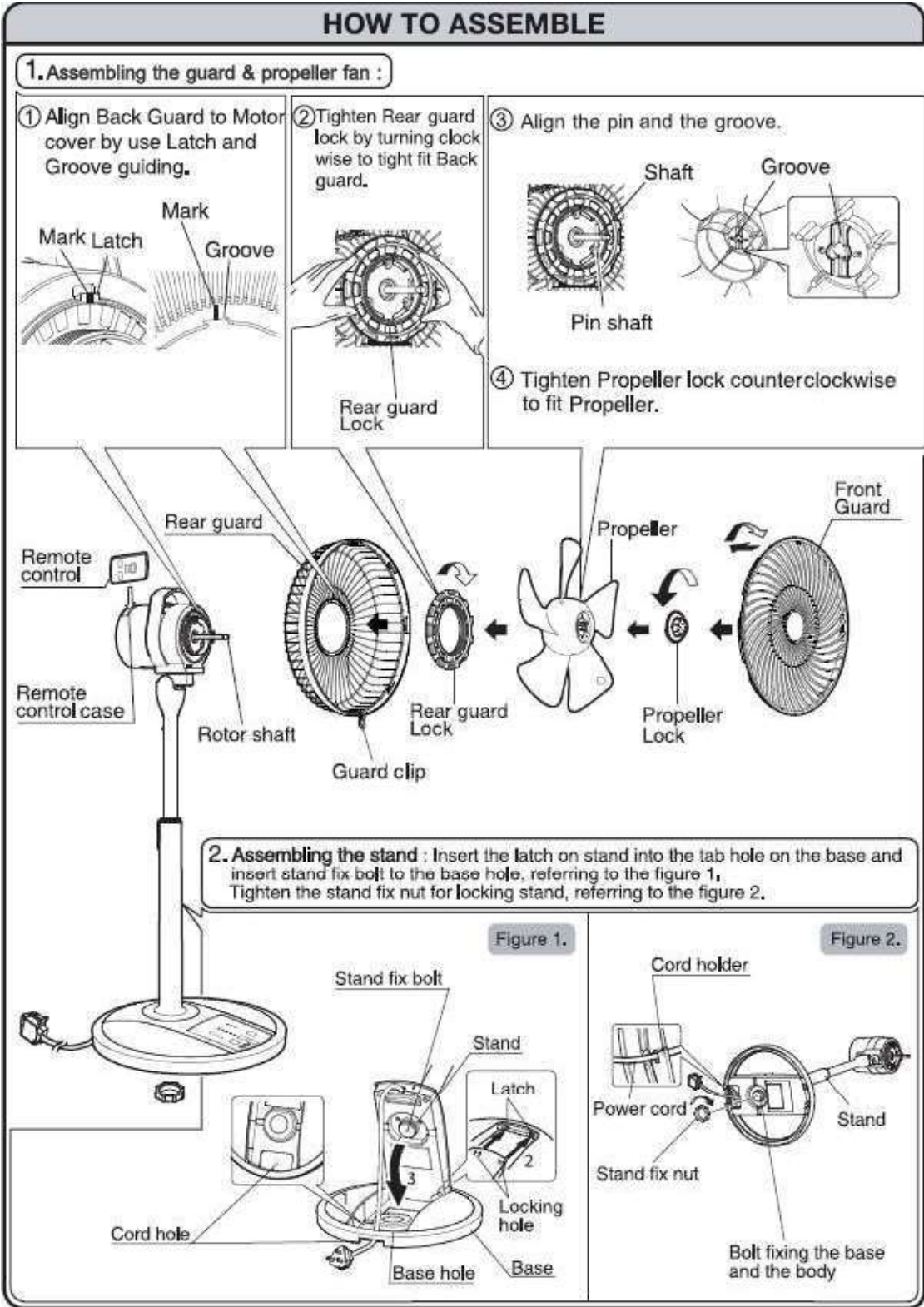

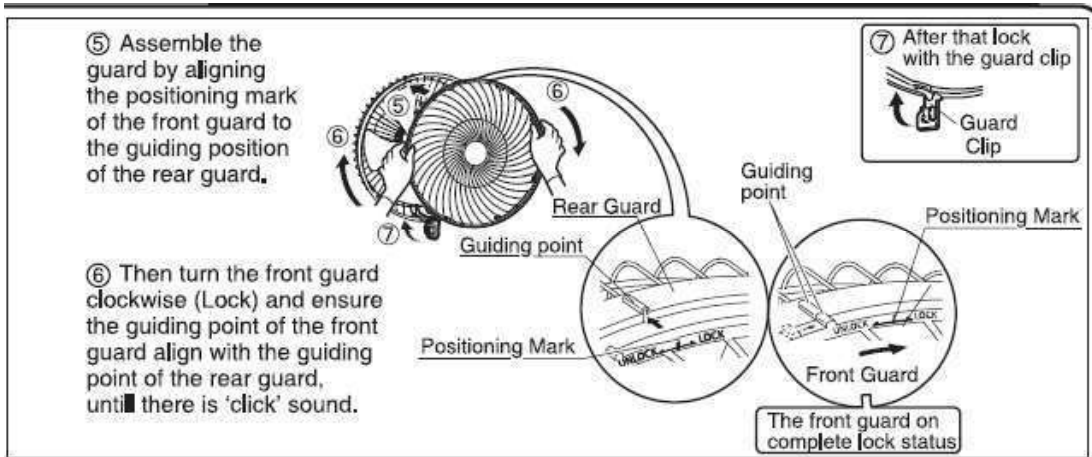

OPERATION OF R30A-HR□, R30A-HR□-P

TIMER :

Time setting, stopping, and start working by pressing timer switch as OFF TIMER or ON TIMER. Each press can change the timer status as below.

OFF TIMER :

Stopping Time Setting (OFF TIMER)

There are 2 options for stopping time setting; gradually reduce the wind speed (SLEEP MODE) or suddenly stop at the setting time.

Gradually reducing wind speed pattern

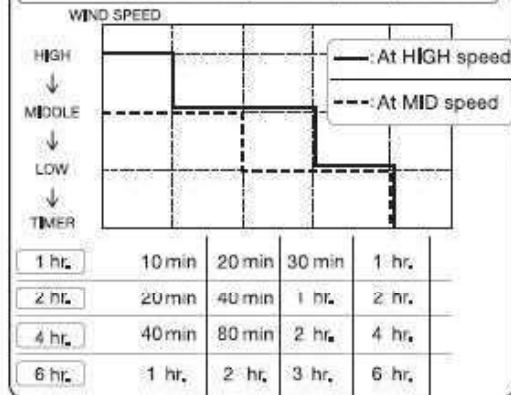

When the fan is at the MID or HIGH position

Time setting as gradually reduce the wind speed

Time setting as suddenly stop operation

When the fan is at the LOW or RHYTHM position

Can be only set the stopping time immediately once the setting time is reached. *Unable to set as gradually stop mode.

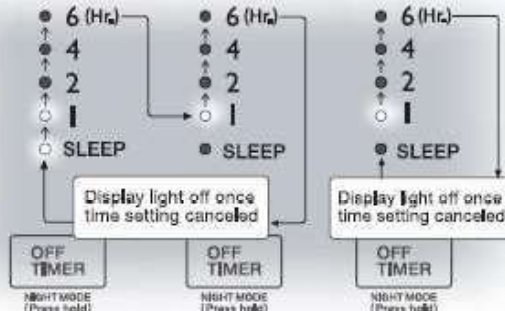

※ Sample of OFF TIMER:

★ To set OFF TIMER as gradually reduce the wind speed at 1 hr, with the wind speed position at HIGH.

● Start time counting;

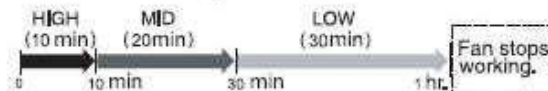

1. MEMORY FUNCTION :

The fan can record the last operation condition (wind speed) after switching off while the power cord is being connected.

When pressing ON/OFF switch to switch on the fan, it can remain the former wind speed. If the power cord is disconnected and then reconnected, the wind speed is always at LOW

2. 8 HR. AUTO OFF :

To prevent from forgetting switching off, when the fan is operating and there is not any switch to be pressed until 8 hours, the fan will automatically stop its operation.

To cancel this, press and hold the OFF TIMER switch and ON TIMER switch simultaneously for 3 seconds.

Then the fan will stop operation and press ON/OFF switch again, in case the power cord is disconnected and reconnected with ON/OFF switch pressing to switch on the fan, AUTO OFF function will be reactivated after 8 hours.

Remarks:

- Each time of pressing switch as OFF TIMER, display light will change accordingly.
- While setting stopping time (OFF TIMER) as SLEEP MODE from the middle or high speed of wind and the switch has been changed to be LOW or RHYTHM, the SLEEP MODE light will be OFF.
- Time length for stopping time setting shall be counted from the setting time is at the last position of setting. If there is any change of time setting, the counter shall restart counting time.
- Operating status of fan shall be canceled once the power cord is disconnected.

To set the starting operation time (ON TIMER), the fan will start working automatically

- The fan will start operation automatically once the setting time is reached at LOW speed and it will stop operation automatically after 2 hours. (can be used with air conditioner by setting the starting time after the air conditioner stops operation or anytime you need.)
- While the fan is stopped and ON TIMER switch is pressed, the light indicator will be changed accordingly.

ON TIMER



Sample of Time Setting

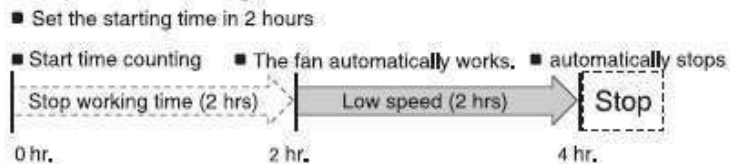

Remarks:

- OFF TIMER can be set after setting the ON TIMER (if there is no OFF TIMER setting, the fan will stop automatically after 2 hours.)
- 5 seconds before the fan starts, the light indicator is flashing at LOW speed.
- The time is counted when ON TIMER is set at the last position. If there is any change of ON TIMER setting, the time will be recounted.
- After the fan starts working automatically due to ON TIMER and any control switch is pressed, the auto stop working after 2 hours will be cancelled.

To set the stopping operation time (OFF TIMER), with ON TIMER setting

- When the OFF TIMER is set first and then ON TIMER is set, the time shall be counted the stopping time first. At the stopping time, the fan will stop and then the time will be recounted for the starting time. At the starting time setting, the fan will start working again. If there is not any switch pressed, the fan will stop after 2 hours.

● 6 hr. ● 6 hr.
○ 4 ○ 4
● 2 ● 2
● 1 ● 1
● SLEEP (MID)
OFF TIMER (Press hold)
ON TIMER (Press hold)

Time Setting Sample :
The fan is at MID wind speed and the OFF TIMER is set at 4 hours, Then the ON TIMER is set at 4 hours,

■ Start counting the starting time ■ Stop working time ■ Start Working

0 1hr. 2hr. 3hr. 4hr. 5hr. 6hr. 7hr. 8hr. 9hr. 10hr.

MID speed (4 hrs) Stop working time (4 hrs) LOW speed (2 hrs) Fan stops working.

- When the ON TIMER is set first and then OFF TIMER is set, the time shall be counted the starting time first. At the starting time, the fan will start automatically and then the time will be recounted for the stopping time. At the stopping time setting, the fan will stop working.

● 6 hr. ● 6 hr.
○ 4 ○ 4
● 2 ○ 2
● 1 ● 1
● SLEEP (MID)
OFF TIMER (Press hold)
ON TIMER (Press hold)

Time Setting Sample :
ON TIMER is set at 2 hours, then the OFF TIMER is set at 4 hours

■ Start counting the starting time ■ Start working time ■ Stop Working

0 1 hr. 2 hr. 3 hr. 4 hr. 5 hr. 6 hr.

Stop working time (2 hrs) LOW speed (4 hrs) Fan stops working.

ON/OFF Switch :
Press ON/OFF switch to start the fan operation and press again to stop operation.

SPECIAL OPTION

- Child Lock mode, designated for preventing from unintentionally misuse by children. When the Child Lock mode is set all the buttons on control panels are locked.**
 - When fan is operating, press and hold "TIMER ON" button for 3 seconds or until hear "beep" sound and LED light at locking key sign is on.
 - In CHILD LOCK mode when fan is operating, all buttons will be deactivated, users will not be able to use any control button, except OFF and CHILD LOCK button.
 - In CHILD LOCK mode when fan is off, all buttons will be deactivated, users will not be able to use any control button, except CHILD LOCK button.
 - To turn off CHILD LOCK mode, press and hold CHILD LOCK button for 3 seconds or until hear "beep" sound for 2 times and LED light is off.



6 Hr
4
2
0

ON
TIMER

Press and hold for 3 Sec.

LED key sign is on when Child Lock mode is activated.

Remarks: While the Child Lock mode is activated, if any button is pressed, the beep will sound 3 times and the LED key sign will flash.

- Night Mode, designated for providing you comfort by deactivating all display light and beep sound, functional during your sleep, night time or other preferred occasion**
 - To activate the Night Mode, press "TIMER OFF" button and hold for 3 seconds (Until the beep sounds and LED is off)
 - To deactivate the Night Mode, press "TIMER OFF" button and hold for 3 seconds (Until the beep sounds twice and LED is on)



6 Hr
4
2
1
SLEEP

OFF
TIMER

Press and hold for 3 Sec.

Remarks: While the Night Mode is activated, if any button is pressed, the LED will flash 3 times without beep sound.

The Installation of remote control battery.

How to Install lithium battery (CR 2025)

- Press the tip pen to rear hold and slide along arrow direction.
- Put holder out.
- Put lithium battery in and always keep ⊕ over holder.
- Pull holder until "click" sound.

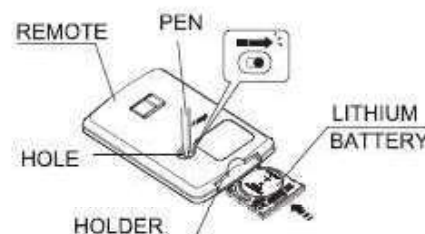

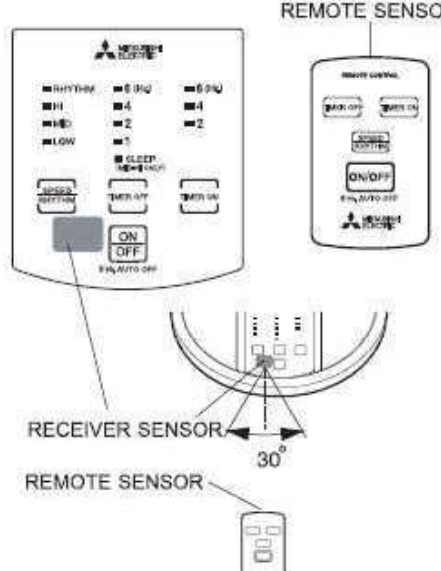

Suggestion



- Do not use others kind of battery.
- Do not drop or impacted remote control.

Receiver Control Panel and Remote Control



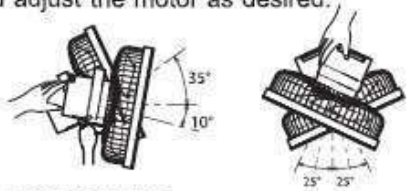
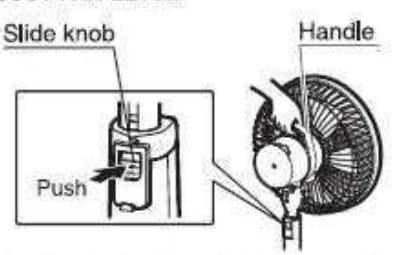
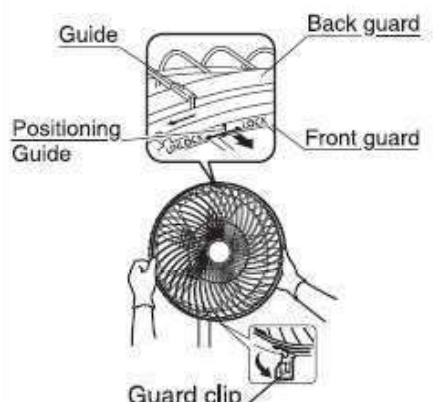
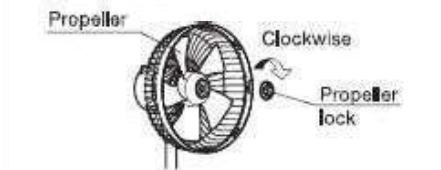
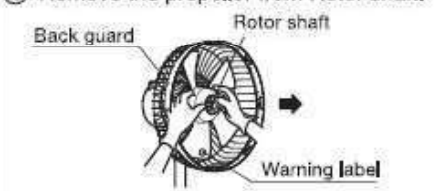
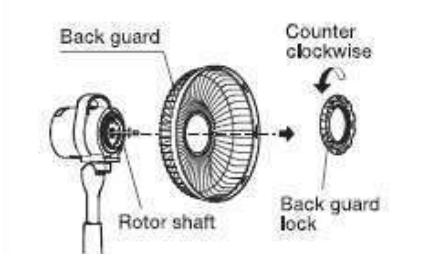
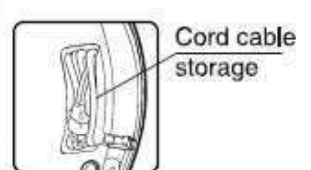

- Remote to control panel the receiver be 4m and 30 degree to the left & right side.
- * In Case of receiver control close the floor. It's might be not operating as condition.
- Low battery. Please change to new lithium battery (CR 2025 model).

Remote Control will not operating with the condition as:

- Remote Control and Receiver Control Panel are damages.
- In case of effective from Inverter or Hi-light equipment.
- In case of effective from sunlight to receiver control panel.
- In case of effective from magnetic (television etc).

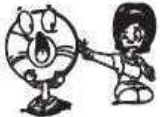
USAGE	MANTANANCE
<p>■ OSCILLATION</p> <ul style="list-style-type: none"> ■ To turn on oscillation, press Swing button, the beep sounds. ■ To turn off oscillation, press Swing button, the beep sounds twice. <div data-bbox="737 394 837 457" style="border: 1px solid black; padding: 2px; display: inline-block;">SWING</div> <p>■ AIR FLOW DIRECTION</p> <ul style="list-style-type: none"> ■ The air flow direction can be adjusted up, down, left or right by gently hold the stand and adjust the motor as desired.  <p>■ ADJUST FAN LEVEL</p>  <ul style="list-style-type: none"> ■ To raise the level of the fan, press the slide knob together with pulling up the motor part to the desired height. ■ To lower the level of the fan, press the slide knob together with lowering the motor part to the desired height. <div data-bbox="277 1247 854 1325" style="border: 1px solid gray; padding: 5px;"> <p>CAUTION: Do not press slide knob unless assemble the guard and propeller fan because the motor part quickly slide up and cause injury.</p> </div>	<p>■ FAN BLADE DISASSEMBLE STEPS</p> <ol style="list-style-type: none"> ① Take the front fan guard out of the back guard by releasing the guard clip and prying the guard lock until latches separated. Then remove the front guard.  ② Remove the propeller lock by turn its clockwise.  ③ Remove the propeller from Rotor shaft.  ④ Remove the back guard lock by rotate counter clock wise. 
<p>■ POWER CORD STORAGE</p>  <p>■ BUILT-IN REMOTE CONTROL CASE</p> <p>Keep the remote control at the motor cover part</p> 	

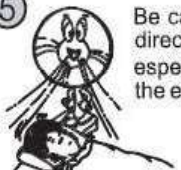
CAUTION

<p>① Do not insert fingers or objects into the guard because propeller fan might be damaged and cause injury.</p> 	<p>④ Do not use the fan near curtain because it can cause damage and accidents.</p> 
<p>② Do not use the fan in : ■ Room temperature over 45 °C ■ Very humid area ■ Near fire or wet area ■ Area containing high amount of oil, chemicals, dust</p> 	<p>⑤ Be careful not to blow the fan wind directly toward body for a long time especially for patient, infants and the elderly.</p> 
<p>③ Do not apply any kind of spray. Otherwise, the plastic parts might be damaged or deformed.</p> 	<p>⑥ If the supply cord of this appliance is damaged, it must only be replaced by a qualified technician or MITSUBISHI SERVICE CENTRE</p> 

CARE INSTRUCTION

1. The fan must switch off from supply mains before removing the guard.
2. To prevent accidents, always unplug the fan before cleaning. Also keep electrical parts out of water.
3. Clean the dirty parts (propeller fan, stand, base, guard, etc.) by using soft cloth, soaked and damped in warm water or mild detergent then wipe dry with soft cloth.
4. Do not use volatile chemicals (gasoline, benzene, thinner, spray cleaner, alcohol, etc.) or other chemicals (treated dust cloths, alkaline soap solutions, boiling water, cleaner, etc.) for cleaning because all of these can damage the plastic parts.
5. If a large amount of dust collects on the propeller fan, it may cause overheating or excessive vibration of the motor. This can lead to burn out and other damages, so be sure to keep the propeller fan clean.
6. This appliance is not intended for use by persons (including children) with reduced physical, sensory or mental capabilities, or lack of experience and knowledge, unless they have been given supervision or instruction concerning use of the appliance by a person responsible for their safety.
7. Children should be supervised to ensure that do not play with the appliance.



Disassembly and repair should not be done unless carrying by a specialized technician (cause of fire, electric shock and Injury). Please consult your MITSUBISHI ELECTRIC dealer or service center.



座檯電風扇 ELECTRIC DESK FAN

型號 / MODEL R30-M□, R30-M□-P

零部件名稱 / PART NAME

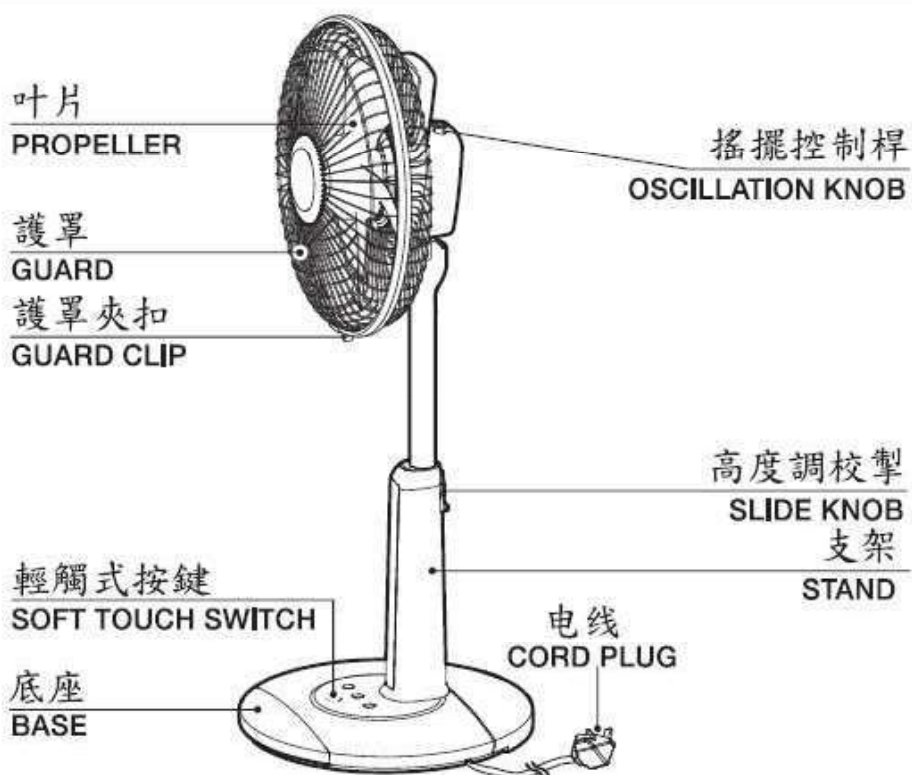

註：□ 乃生產年份的代表字母
REMARK：□ IS THE ALPHABET OF PRODUCTION YEAR

安裝及操作前請先細閱本說明書，以確保安全。
FOR SAFETY, PLEASE READ THIS MANUAL PRIOR TO INSTALL AND OPERATING

安裝法 / ASSEMBLY

1. 电扇底座装配法 Steps of Basic Assembly

① 为了松开电扇底座的扣环, 把扣环螺栓逆时针方向地旋转出来。
Release Stand fix nut by turning it counterclockwise.



电扇底座 Base
电扇底座的扣环 Stand fix nut

② 为了把电扇底座和体部装配在一起, 装进螺栓使电扇的体部与电扇底座固定, 同时把电线穿进下面的孔间, 然后把纺锤锁插入到锁间里面。
Attach the base with the body by tightening locking Fan axis on the fan body and the base and inserting the cord cable into the hole. Then insert the locking latch into its hole.

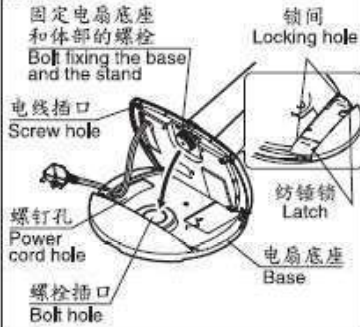

固定电扇底座和体部的螺栓 Bolt fixing the base and the stand
电线插口 Screw hole
螺钉孔 Power cord hole
螺栓插口 Bolt hole
锁间 Locking hole
纺锤锁 Latch
电扇底座 Base

③ 紧扭电扇底座的每一个螺钉。
Tightening all screws at the base.

④ 紧紧固定电扇底座的扣环, 顺行地旋转进去。
Tightening the stand fix nut at the base by turning clockwise.

⑤ 把电线穿过电线扣环和侧面的电线孔。
Insert power cord via cord holder and cord hole at the side.

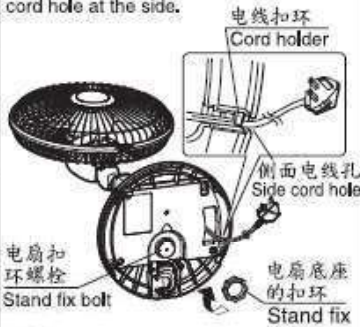

电线扣环 Cord holder
侧面电线孔 Side cord hole
电扇扣环螺栓 Stand fix bolt
电扇底座的扣环 Stand fix nut

2. 組裝護罩及扇葉 / Assembling the guard & propeller fan :

① 裝上後護罩時, 對準有標誌的地
Align Back Guard to Motor cover by use Latch and Groove guiding.



標誌 Mark
門 Latch
標誌 Mark
槽 Groove

② 護罩的固定螺母順時針旋轉, 然後在後衛去擰緊固定, 以便沒有世紀。
Tighten Back guard lock by turning clockwise to tight fit Back guard.



③ 把橫栓對準插槽。
Align the pin shaft and the groove.

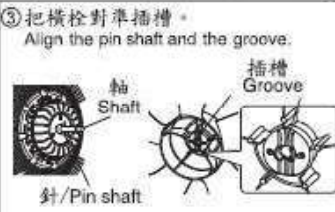

插槽 Groove
軸 Shaft
針/Pin shaft

④ 擰緊微調反順時針方向, 以適應刀片。
Tighten Propeller lock counterclockwise to fit Propeller.



⑤ 對準護罩上的標記, 然後把前護罩套上。
Align with the mark on the back guard and hang on.



標記 MARK

⑥ 同時使用雙手把前護罩完全套上。
Use both hands to fit into place.



⑦ 加上護罩夾
Lock guard clip



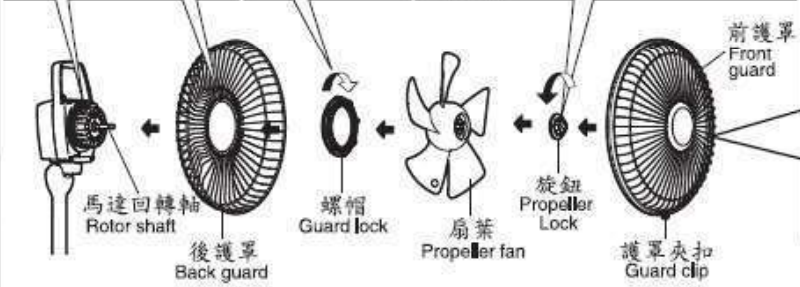

馬達回轉軸 Rotor shaft
後護罩 Back guard
螺帽 Guard lock
扇葉 Propeller fan
旋鈕 Propeller Lock
前護罩 Front guard
護罩夾扣 Guard clip

1. MEMORY FUNCTION :

The fan can record the last operation condition (wind speed) after switching off while the power cord is being connected. When pressing ON/OFF switch to switch on the fan, it can remain the former wind speed. If the power cord is disconnected and then reconnected, the wind speed is always at LOW

2. 8 HR. AUTO OFF :

To prevent from forgetting switching off, when the fan is operating and there is not any switch to be pressed until 8 hours, the fan will automatically stop its operation. To cancel this, press and hold the OFF TIMER switch and ON TIMER switch simultaneously for 3 seconds. Then the fan will stop operation and press ON/OFF switch again. In case the power cord is disconnected and reconnected with ON/OFF switch pressing to switch on the fan, AUTO OFF function will be reactivated after 8 hours.

模型R30-M□, R30-M□-P的应用法 / OPERATION OF R30-M□, R30-M□-P

定时器 (TIMER) :

● 可以定关闭和开动时, 按关闭定时电键或者开动定时电键, 每当按着以上的电键, 定时状况将如下变换:
 ■ Time setting, stopping, and start working by pressing timer switch as OFF TIMER or ON TIMER. Each press can change the timer status as below.

关闭定时 (OFF TIMER) :

● 可以定关闭时间为 2 模式: 休眠模式 (SLEEP MODE) 风速将会慢慢地停下, 或者立即关闭。

Stopping Time Setting (OFF TIMER)

■ There 2 options for stopping time setting; gradually reduce the wind speed (SLEEP MODE) or suddenly stop at the setting time.

附注 / Remarks :

- 当每一次按着关闭定时电键的时候, 定时状况指示灯将按着先前定为变更的。
- 如果当电扇在被定为中速 (MID) 或高速 (HIGH) 然后换成低速 (LOW) 或自然风速 (RHYTHM) 的时候定着关闭时间为休眠模式的话, 休眠模式关闭定时状况灯将会关掉。
- 关闭定时的时间将被开始数算当关闭定时以被定在定时间的最后定位, 接着当重新定着关闭时间的时候, 电扇系统也将会重新开始数算时间。
- 电扇的各个运行状况将被取消当拔开电扇插头的时候。
- Each time of pressing switch as OFF TIMER, display light will change accordingly.
- While setting stopping time (OFF TIMER) as SLEEP MODE from the middle or high speed of wind and the switch has been changed to be LOW or RHYTHM, the SLEEP MODE light will be OFF.
- Time length for stopping time setting shall be counted from the setting time is at the last position of setting.
- If there is any change of time setting, the counter shall restart counting time.
- Operating status of fan shall be canceled once the power cord is disconnected.

开-关电键 ON/OFF / ON/OFF Switch :

按 ON/OFF 电键为了让电扇开动, 如果想要关掉, 再按一次 Press ON/OFF switch to start the fan operation and press again to stop operation.

● 当电扇以被定在 '中速' (MID) 或 '高速' (HIGH) 的时候。
 ■ When the fan is at the MID or HIGH position

● 当电扇以被定在 '低速' (LOW) 或 '自然风速' (RHYTHM) 的时候。
 ■ When the fan is at the LOW or RHYTHM position

当到先前定的时间, 只可以定为立即关闭模式, 不可以定为休眠模式。 Can be only set the stopping time immediately once the setting time is reached, *Unable to set as gradually stop mode.

休眠模式 关闭定时
Time setting as gradually reduce the wind speed

立即关闭模式 关闭定时
Time setting as suddenly stop operation

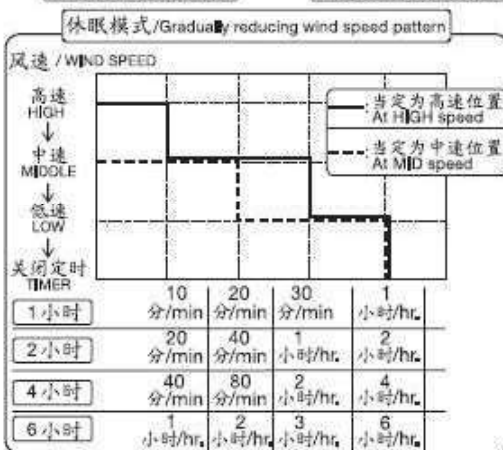
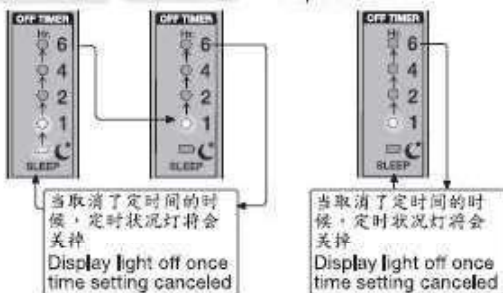

※ 关闭定时举例 / Sample of OFF TIMER:
 定为1小时休眠模式关闭定时与定风速为 '高速' (HIGH)
 ★ To set OFF TIMER as gradually reduce the wind speed at 1 hr. with the wind speed position at HIGH.

- 开始数算...
- Start time counting;

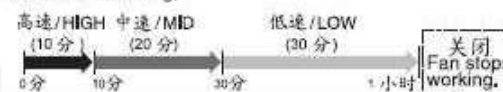

1. 关于记忆功能 (MEMORY FUNCTION)

当关掉电扇但还插上插头之后, 电扇可以记录最后运行状况 (风速)。当按着开-关电键为打开电扇, 电扇将还会留下先前定的风速位置。但如果拔开电扇插头再插上一次, 当打开电扇的时候, 风速状况将总是开始为低速。

2. 关于8小时后自动关闭功能 (8 HR. AUTO OFF)

为了预防忘了关掉电扇, 当电扇正在运行以及没有按着哪个电键 8 个小时的时候, 电扇将会自动关闭。但如果您想要取消自动关闭功能, 一起按着关闭定时电键和打开定时电键 3 秒, 电扇应该被关掉, 如您将要用电扇一次, 按开-关电键 (ON/OFF)。如果拔开电扇插头后再插上一次和按着开-关电键 (ON/OFF) 的话, 这 8 小时后自动关闭功能将会重新开动一次。

模型R30-M□, R30-M□-P的应用法 / OPERATION OF R30-M□, R30-M□-P (Continue)

电扇打开定时(ON TIMER)将自动运行 / To set the starting operation time (ON TIMER), the fan will start working automatically

- 电扇将会自动运行当到先前设定的时间, 即将在'低速'(LOW), 接着将自动关闭当通过了2小时之后。(可以用于空调器, 当关掉空调器了之后, 电扇将自动持续运行或用这个功能当您想要让电扇自动打开的时候)
- 当电扇以被关掉而按着'打开定时'电键的时候, 定时状况灯将会按着每一次按着'打开定时'电键变更。
- The fan will start operation automatically once the setting time is reached at LOW speed and it will stop operation automatically after 2 hours. (can be used with air conditioner by setting the starting time after the air conditioner stops operation or anytime you need.)
- While the fan is stopped and ON TIMER switch is pressed, the light indicator will be changed accordingly.



当取消了定时时间的时候, 定时状况灯将会关掉
The light indicator OFF when the setting time is cancelled.

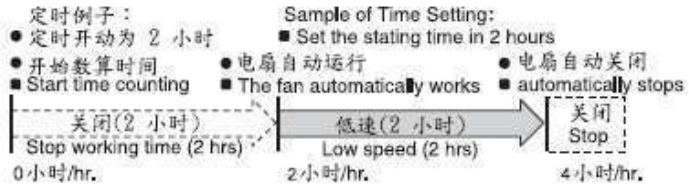

附注 / Remarks:

- 可以接着打开定时来定关闭定时(如果没有定着关闭定时的话, 当通过了2小时之后, 电扇将会自动关掉)
- 当电扇开始运行5秒之前, '低速'(LOW)定时状况灯将闪烁。
- 系统将开始计算时间当'打开定时'以被定为最后位置, 但如果有变换, 系统将会开始再来依次计算。
- 当电扇自动运行之后, 因为关于'打开定时'(ON TIMER)功能, 如果有按着无论哪个控制电键的话, 会让'2小时后自动关闭'功能以被立即取消。
- OFF TIMER can be set after setting the ON TIMER (if there is no OFF TIMER setting, the fan will stop automatically after 2 hours.)
- 5 seconds before the fan starts, the light indicator is flashing at LOW speed.
- The time is counted when ON TIMER is set at the last position. If there is any change of ON TIMER setting, the time will be recounted.
- After the fan starts working automatically due to ON TIMER and any control switch is pressed, the auto stop working after 2 hours will be cancelled.

电扇关闭定时(OFF TIMER)共同用于电扇打开定时(ON TIMER)一起

To set the stopping operation time (OFF TIMER), with ON TIMER setting

- 如果先定关闭定时(OFF TIMER), 然后再定打开定时(ON TIMER), 时间将被先从关闭定时开始计算直到先前已定的时间, 然后电扇将停止关闭。从那以后, 系统将重新计算时间和重新运行直到先前已定的打开时间, 电扇将再来一次运行, 但如果没有按着那一个控制电键的话, 电扇将在通过2小时以后自动停止关闭。
- When the OFF TIMER is set first and then ON TIMER is set, the time shall be counted the stopping time first. At the stopping time, the fan will stop and then the time will be recounted for the starting time. At the starting time setting, the fan will start working again. If there is not any switch pressed, the fan will stop after 2 hours,



定时例子: Time Setting Sample:
先定为'中速'(MID)再定'关闭定时'(OFF TIMER)让电扇4小时以后自动关闭。然后定'打开定时'让电扇在通过4小时以后自动打开。

Time Setting Sample:
The fan is at MID wind speed and the OFF TIMER is set at 4 hours. Then the ON TIMER is set at 4 hours.

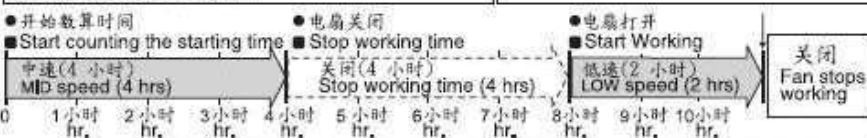

- 如果先定打开定时(ON TIMER), 然后再定关闭定时(OFF TIMER), 时间将被先从打开定时开始计算直到先前已定的时间, 电扇将自动运行。从那以后, 系统将重新计算关闭时间直到先前已定的关闭时间, 电扇将自动停止关闭。
- When the ON TIMER is set first and then OFF TIMER is set, the time shall be counted the starting time first. At the starting time, the fan will start automatically and then the time will be recounted for the stopping time. At the stopping time setting, the fan will stop working.



维修法 / MAINTENANCE

搖擺送風 / OSCILLATION

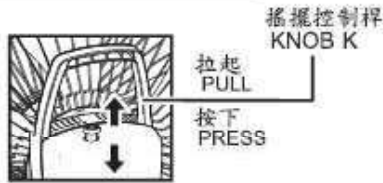

- 按下搖擺控制桿，即可啟動搖擺送風功能。
- 拉起搖擺控制桿，即可停止搖擺送風功能。
- Press Knob K to start fan oscillation.
- Pull Knob K to stop fan oscillation.

送風方向 / AIR FLOW DIRECTION



- 本機可供向上、下、左、右調校風向，只需輕握支架，把馬達調校到所需方向即可。
- The air flow direction can be adjusted up, down, left or right by gently hold the stand and adjust the motor as desired.

高度調校 / HEIGHT ADJUSTMENT

- 要提升風扇高度，按住高度調校掣，把馬達部分拉起至所需高度。
- 要降低風扇高度，按住高度調校掣，把馬達部分降低至所需高度。
- To raise the level of the fan, press the slide knob together with pulling up the motor part to the desired height.
- To lower the level of the fan, press the slide knob together with lowering the motor part to the desired height.

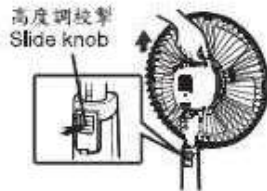

注意：組裝護罩及扇葉前，請勿按高度調校掣，否則馬達部分迅速滑起可能引致受傷。
CAUTION: Do not press slide knob unless assemble the guard and propeller fan because the motor part quickly slide up and cause injury.

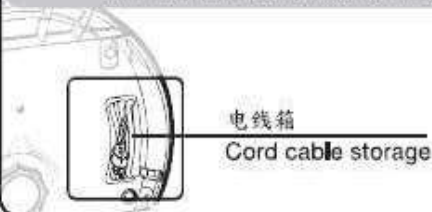

電扇葉片裝卸法 FAN BLADE DISASSEMBLE STEPS

- ① 為了旋開前-后電扇網罩，先脫出網罩的鎖夾子，再掀起網罩的扣環直到鎖釘从后電扇網罩分离出来为止，然后再脱前电扇网罩出来。
Take the front fan guard out of the back guard by releasing the guard clip and prying the guard latch until latches separated. Then remove the front guard.



- ② 為了脫出電扇葉片的撞鎖，把它順行地旋轉出來。
Release fan blade knob by turning clockwise.

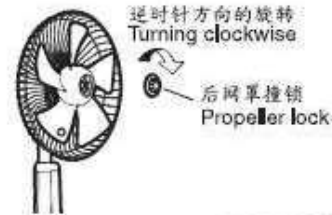

- ③ 為了脫出電扇后网罩的撞鎖，把它逆时针方向地旋轉出來。
Remove fan blade from the shaft rod.



- ④ 為了脫出電扇后网罩的撞鎖，把它逆时针方向地旋轉出來。
Remove back guard stopper by turning it counterclockwise.

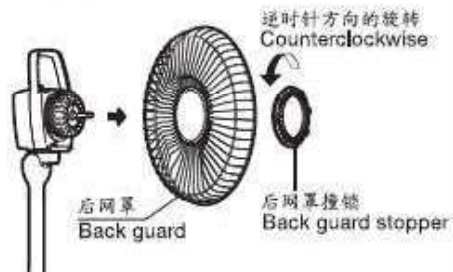

警告 / CAUTION

① 切勿將手指或其他物件放進護罩內，否則可能損害扇葉或引致受傷。
Do not insert fingers or objects into the guard because propeller fan might be damaged and cause injury.



④ 請勿在靠近窗簾的位置使用本機，以免造成損壞或意外。
Do not use the fan near curtain because it can cause damage and accidents.



② 請勿在下列環境中使用本機：
• 室溫高於45°C
• 極度潮濕的地方
• 靠近火種或容易被水濺濕的地方
• 存放大量燃油、化學品或滿佈塵埃的地方
Do not use the fan in :
■ Room temperature over 45°C
■ Very humid area
■ Near fire or wet area
■ Area containing high amount of oil, chemicals, dust



⑤ 避免將風扇長時間直吹向人體，特別是病人、嬰兒及長者。
Be careful not to blow the fan wind directly toward body for a long time especially for patient, infants and the elderly.



③ 請勿在本機上使用任何噴霧劑，否則塑料零部件可能受損或變形。
Do not apply any kind of spray. Otherwise, the plastic parts might be damaged or deformed.



⑥ If the supply cord of this appliance is damaged, it must only be replaced by a qualified technician or MITSUBISHI SERVICE
若本機電源線受損，不應自行修理，必須送交合資格技術人員或三菱電機維修服務中心修理。



保養須知 / CARE INSTRUCTION

1. 在移除保護罩前，必先將電風扇關閉及將電源線拔掉。
 2. 為免發生意外，清潔前請拔除插頭，並避免把通電的零部件沾濕。
 3. 要清潔零部件(例如：扇葉、支架、底座、護罩等)，請用浸過溫水或沾上溫和清潔劑的軟布拭抹，再用軟布抹乾。
 4. 切勿使用揮發性化學品(例如：汽油、苯、稀釋劑、清潔噴霧劑、酒精等)或其他化學品(例如：經化學處理的除塵布、鹼性肥皂液、沸水、清潔劑等)清潔本機，以免損害塑料零部件。
 5. 假如扇葉積聚大量塵埃，或會令馬達因過熱或震動過度而燒毀或損壞，所以請確保扇葉清潔。
 6. 兒童應在成人陪同下使用本機，以確保安全。
 7. 不論本產品是否正在運作，請指導並確保兒童不會把玩本機，避免發生意外。
1. The fan must switch off from supply mains before removing the guard.
 2. To prevent accidents, always unplug the fan before cleaning. Also keep electrical parts out of water.
 3. Clean the dirty parts (propeller fan, stand, base, guard, etc.) by using soft cloth, soaked and damped in warm water or mild detergent then wipe dry with soft cloth.
 4. Do not use volatile chemicals (gasoline, benzene, thinner, spray cleaner, alcohol, etc.) or other chemicals (treated dust cloths, alkaline soap solutions, boiling water, cleaner, etc.) for cleaning because all of these can damage the plastic parts.
 5. If a large amount of dust collects on the propeller fan, it may cause overheating or excessive vibration of the motor. This can lead to burn out and other damages, so be sure to keep the propeller fan clean.
 6. This appliance is not intended for use by persons (including children) with reduced physical, sensory or mental capabilities, or lack of experience and knowledge, unless they have been given supervision or instruction concerning use of the appliance by a person responsible for their safety.
 7. Children should be supervised to ensure that do not play with the appliance.



- 不論任何情況，不應對產品進行修改，產品拆卸及維修必須交由專業技術人員負責(以免引起火警、觸電或受傷)。如有疑問，請向三菱電機經銷商或維修服務中心查詢。
- Disassembly and repair should not be done unless carrying by a specialized technician (cause of fire, electric shock and injury). Please consult your MITSUBISHI ELECTRIC dealer or service center.

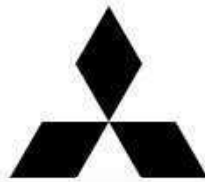

**mitsubishi
ELECTRIC**

ELECTRIC PEDESTAL FAN

QUẠT ĐỨNG

MODEL LV16-G□, LV16-R□

PART NAME / CÁC CHI TIẾT CẤU TẠO

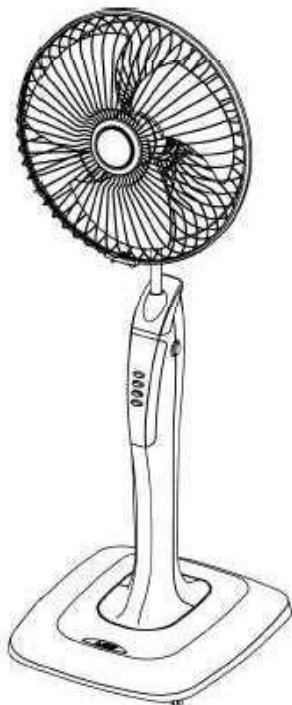

LV16-G□



REMOTE CONTROL
(MODEL LV16-R□ ONLY)

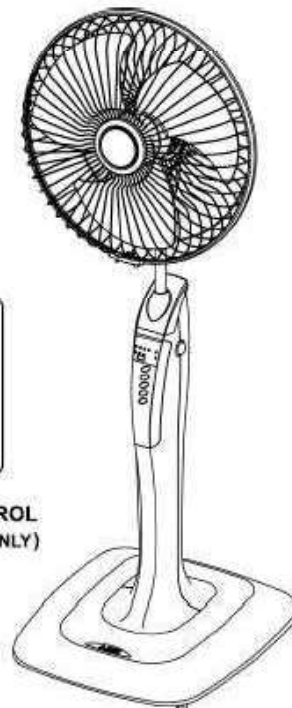

LV16-R□

REMARK : □ IS THE ALPHABET OF PRODUCTION YEAR

CHÚ Ý : □ LÀ CHỮ CÁI KÝ HIỆU CHO NĂM SẢN XUẤT

FOR SAFETY, PLEASE READ THIS MANUAL PRIOR TO INSTALL AND OPERATING
VÌ LÝ DO AN TOÀN, VUI LÒNG ĐỌC KỸ TÀI LIỆU HƯỚNG DẪN TRƯỚC KHI LẮP RÁP VÀ SỬ DỤNG

HOW TO ASSEMBLE / HƯỚNG DẪN LẮP RÁP

1. Remove the two set bolts that are under stand.
- 1/ Tháo 2 bộ bu-lông dưới thân quạt
2. Insert the tab on the stand into the tab hole on the base, pass the power cord through the cord case hole of the base and gently fit the stand into the base. (referring to the Figure 1.)
- 2/ Lắp gá chặn trên thân quạt vào lỗ ở chân đế, luồn dây điện qua lỗ và lắp thân vào chân đế (xem hình 1)

Figure 1. / Hình 1.

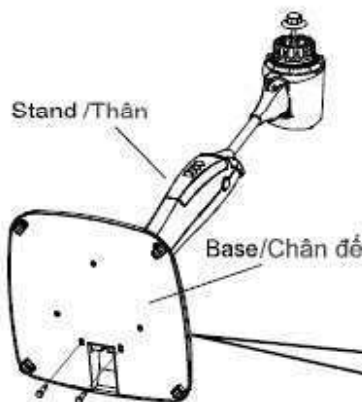
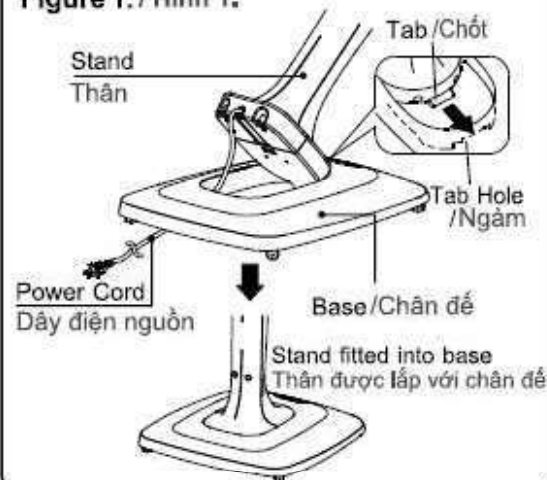
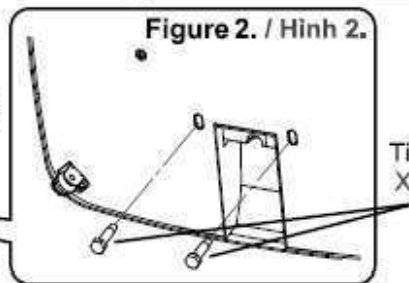
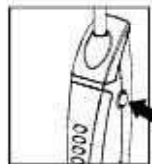

Figure 2. / Hình 2.



3. Hold the stand and base in order to fit together and gently tilt them to the side. Secure the stand to the base using the set bolts removed in step 1. (referring to the Figure 2.)
- 3/ Giữ thân và chân đế khớp với nhau và nhẹ nhàng nghiêng cả 2 về phía sau. Dùng bu-lông siết chặt thân và chân đế (xem hình 2)

HEIGHT ADJUSTMENT ĐIỀU CHỈNH ĐỘ CAO



- Press the slide knob with the motor part hold, pull up (for raise the level of motor) or push down (for lower the level of motor) the motor part to the desired height, and leave the slide knob.
- Nhấn và giữ phím trượt bên hông thân quạt, dùng tay nâng hoặc hạ cụm mô-tơ cánh quạt để chỉnh độ cao phù hợp. Sau đó thả phím trượt ra để cố định chiều cao.

AIR FLOW DIRECTION ĐIỀU CHỈNH HƯỚNG GIÓ

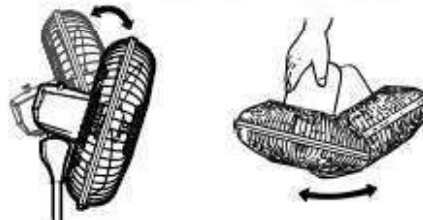

- The air flow direction can be adjusted up, of down, left or right by gently hold the stand and adjust the motor as desired.
- Hướng gió có thể điều chỉnh lên, xuống, trái hoặc phải bằng cách giữ thân quạt rồi xoay cụm mô-tơ đến vị trí mong muốn.

HOW TO ASSEMBLE / HƯỚNG DẪN LẮP RÁP

4. Assemble the guard and propeller fan. (referring to the figure 3.)
 4/ Lắp lồng bảo vệ và cánh quạt (xem hình 3)

Before assemble
 Trước khi lắp ráp

- Remove the spinner
Tháo nắp chụp
- Remove the SPL nut
Tháo vòng chặn SPL

① Align with the mark on the back guard and hang on.
 Lắp vào theo dấu định vị trên lồng sau

Mark Dấu

② Use both hands to fit into place.
 Dùng 2 tay lắp vào đúng vị trí

③ Lock guard clip.
 Khóa chốt kẹp

Figure 3. / Hình 3.

HOW TO USE / HƯỚNG DẪN SỬ DỤNG: LV16-G□

Press one of the three push button switches (1,2 or 3) to turn the fan on.
 Nhấn 1 trong 3 nút (1, 2 hoặc 3) để bật quạt

Press "3" for the highest fan speed.
 Nhấn "3" để chọn tốc độ cao

Press "2" for the medium fan speed.
 Nhấn "2" để chọn tốc độ trung bình

Press "1" for the lowest fan speed.
 Nhấn "1" để chọn tốc độ thấp

Press "0" to turn off.
 Nhấn "0" để tắt quạt

OSCILLATION
 CHỨC NĂNG ĐẢO GIÓ

KNOB K
 Nút K

Pull Knob K to stop fan oscillation.
 Kéo nút K lên để tắt chức năng đảo gió

Push Knob K to start fan oscillation.
 Nhấn nút K xuống để bật chức năng đảo gió

REMARK : □ IS THE ALPHABET OF PRODUCTION YEAR
 CHÚ Ý : □ LÀ CHỮ CÁI KÝ HIỆU CHO NĂM SẢN XUẤT

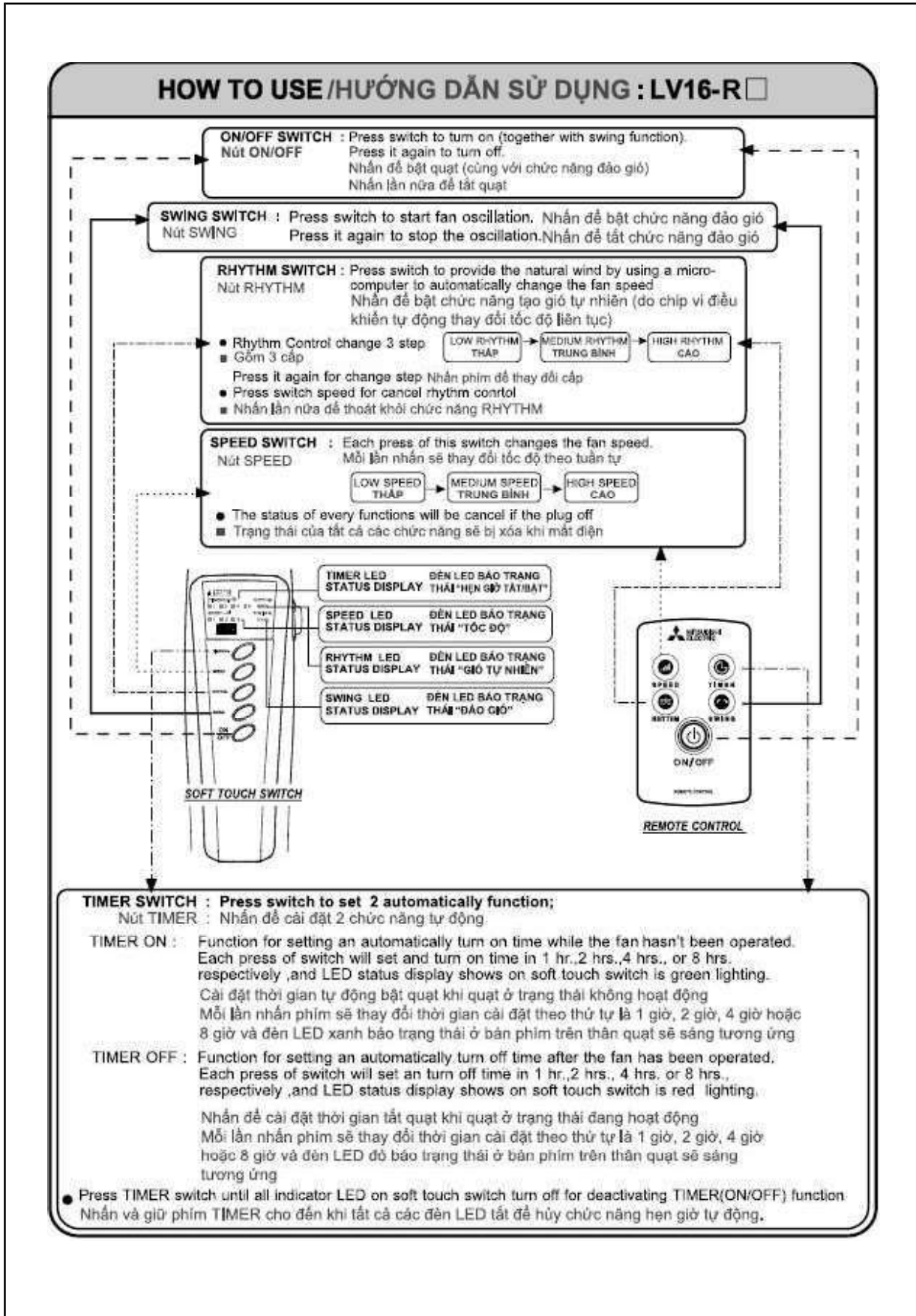

CAUTION CHÚ Ý AN TOÀN

- 1 Do not insert fingers or objects into the guard because propeller fan might be damaged and cause injury.

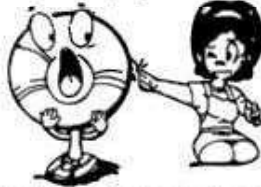

Không để ngón tay hoặc các vật thể khác vào bên trong lồng bảo vệ vì có thể làm hỏng cánh quạt cũng như làm bị thương người sử dụng.

- 2 Do not use the fan in :
• Room temperature over 45 °C



- Very humid area
- Near fire or wet area
- Area containing high amount of oil, chemicals, dust

Không sử dụng quạt khi nhiệt độ phòng hơn 45°C,

- ở nơi có độ ẩm cao,
- gần lửa và nước
- nơi có chứa nhiều dầu hỏa, hóa chất và bụi.

- 3 Do not apply any kind of spray. Otherwise, the plastic parts might be damaged or deformed.



Không được phun bất kỳ dung dịch nào vào quạt để tránh làm hỏng và biến dạng các chi tiết nhựa.

- 4 Do not use the fan near curtain because it can cause damage and accidents.

Không sử dụng quạt ở gần màn cửa vì có nguy cơ hư hỏng cũng như gây tai nạn.



- 5 Be careful not to blow the fan wind directly toward body for a long time especially for patient, infants and the elderly.



Không để quạt thổi gió trực tiếp vào người dùng trong thời gian dài, đặc biệt là người bệnh, trẻ em và người già.

- 6 If the supply cord of this appliance is damaged, it must only be replaced by a qualified technician or MITSUBISHI SERVICE

Nếu dây dẫn nguồn bị hỏng thì phải do nhà sản xuất hoặc đại lý dịch vụ hoặc những người có trình độ tương đương sửa chữa thay thế nhằm đảm bảo an toàn phòng ngừa sự cố nguy hiểm.



- 7 Caution for "Remote Control" feature :
• Insert pole (+, -) of battery properly.
• Keep remote control in a proper place. Do not lose it because it controls the operation of the fan.
• Use only a size of battery : CR 2025 (3.0 V)
• Remote control should be used carefully. Do not break it.

Lưu ý về việc sử dụng ĐKTX:

- + Lắp pin đúng điện cực +,-
- + Chỉ sử dụng pin loại: CR 2025 (3.0V)
- + Giữ ĐKTX ở nơi thích hợp. Không làm mất ĐKTX vì ĐKTX được dùng để điều khiển quạt
- + Sử dụng ĐKTX cẩn thận, tránh làm hỏng

CARE INSTRUCTION / HƯỚNG DẪN BẢO QUẢN

1. To prevent accidents, always unplug the fan before cleaning. Also keep electrical parts out of water.
2. Clean the dirty parts (propeller fan, stand, base, guard, etc.) by using soft cloth, soaked and damped in warm water or mild detergent then wipe dry with soft cloth.
3. Do not use volatile chemicals (gasoline, benzene, thinner, spray cleaner, alcohol, etc.) or other chemicals (treated dust cloths, alkaline soap solutions, boiling water, cleaner, etc.) for cleaning because all of these can damage the plastic parts.
4. If a large amount of dust collects on the propeller fan, it may cause overheating or excessive vibration of the motor. This can lead to burn out and other damages, so be sure to keep the propeller fan clean.
5. The appliance is not intended for use by young children or infirm persons unless they have been adequately supervised by a responsible person to ensure that can use the appliance safely.
6. Young children should be supervised to ensure that do not play with the appliance.

- 1/ Để tránh tai nạn, luôn luôn rút dây điện trước khi làm vệ sinh quạt. Không được để các chi tiết dẫn điện tiếp xúc với nước.
- 2/ Vệ sinh các chi tiết (cánh, thân, đế, lồng quạt, ...) bằng vải mềm ngâm nước ấm và bột giặt, sau đó lau khô bằng vải mềm.
- 3/ Không dùng các loại hóa chất dễ bay hơi (như xăng, cồn, ...) hoặc các loại hóa chất khác (như nước nóng, chất tẩy rửa, ...) để vệ sinh vì có thể làm hư hại các chi tiết nhựa.
- 4/ Nếu bụi bám nhiều trên cánh quạt, có thể gây quá nhiệt hoặc rung động mô-tơ quá mức. Đây cũng là nguyên nhân dẫn đến cháy hoặc dẫn đến các hư hỏng khác. Do đó cần vệ sinh cánh quạt thường xuyên.
- 5/ Không để trẻ em và người thiếu năng sử dụng quạt nếu không có người kiểm soát việc sử dụng 1 cách an toàn.
- 6/ Không để trẻ em chơi đùa với quạt.

WARNING/CẢNH BÁO

- This product must not be disassembled under any circumstances. Only authorized repair technicians are qualified to conduct disassembly and repairs. (Failure to heed this warning may result in fire, Electric shock or injury).
- Không được tháo rời quạt trong bất kỳ trường hợp nào. Việc tháo rời và sửa chữa chỉ được phép thực hiện bởi kỹ thuật viên của các trung tâm dịch vụ được ủy quyền. (Nếu không tuân theo cảnh báo trên có thể sẽ gây ra hỏa hoạn, điện giật hoặc tai nạn gây thương tích)





座地電風扇

ELECTRIC PEDESTAL FAN

型號/MODEL

LV16S-R□, LV16S-R□-P

產品外觀/PRODUCT APPEARANCE

遙控器
REMOTE CONTROL

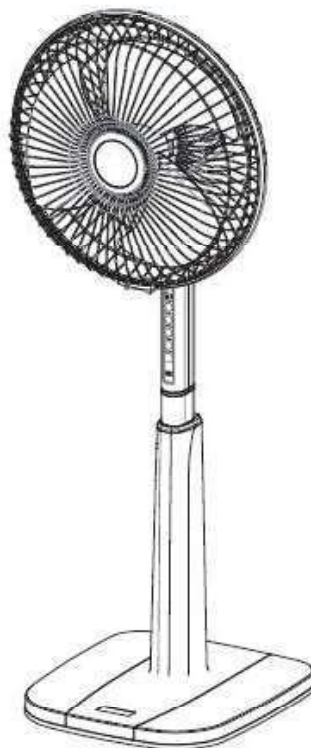

註：□ 乃生產年份的代表字母

REMARK：□ IS THE ALPHABET OF PRODUCTION YEAR

安裝及操作前請先細閱本說明書，以確保安全。

FOR SAFETY, PLEASE READ THIS MANUAL PRIOR TO INSTALL AND OPERATING

組裝方法/HOW TO ASSEMBLE



⚠ 注意/CAUTION

- 錯誤安裝後護罩，有可能會產生噪音如下：
- 當風扇啟動時，扇葉與螺帽的接觸點，會引起噪音。
 - 當風扇啟動時，若安裝不平衡，會引致噪音。
- Incorrectly fastening the back guard lock may cause asymmetrical noise as a consequence of:-
- The contact between the propeller and the guard lock which causes noise while fan is operating.
 - Mismatch of the balance which causes noise while fan is operating.

⚠ 警告/WARNING

禁止使用未完成安裝底座的電風扇
(電風扇可塌下並造成傷害)
Do not switch on the electric fan unless stand is installed properly.
(Fan may collapse and cause injury)

組裝方法 / HOW TO ASSEMBLE

⑥ 裝上護罩及扇葉 (見圖3)。

Assemble the guard and blade. (referring to the figure 3.)

組裝前: Before assemble

- 拆下旋鈕及螺帽
- Remove the spinner and the SPL nut.



螺帽
SPL nut



圖 / Figure 3.

① 對準護罩上的標記，然後把前護罩套上。

Align with the mark on back guard and put two guards together.

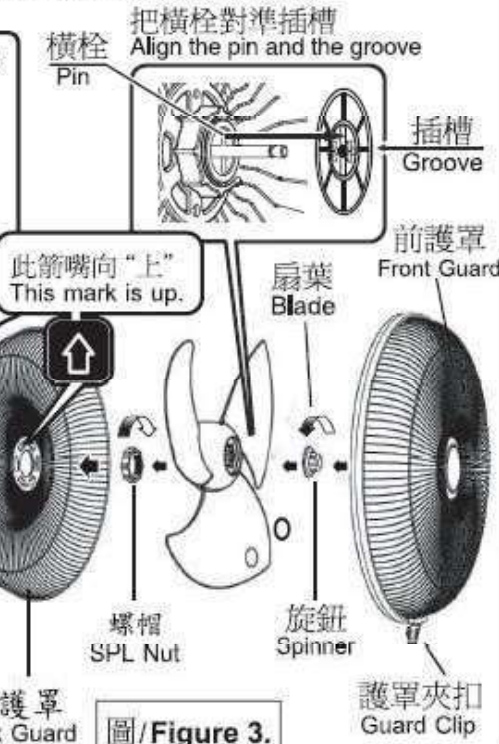

② 同時使用雙手把前護罩完全套上。



③ 扣上護罩夾



風向 / AIR FLOW DIRECTION



- 本機可供向上、下、左、右調校風向。調校時，先扶穩風扇支架，把馬達調校到所需方向即可。
- The air flow direction can be adjusted up or down, left or right by gently holding the stand and adjusting the motor as desired.

高度調校 / HEIGHT ADJUSTMENT



提示標貼
Warning sticker

高度調校掣
Slide knob

- 先扶穩馬達部分，按下高度調校掣，即可把馬達部分拉起（提升馬達的高度）或推下（降低馬達的高度）至所需高度，然後鬆開高度調校掣。
- Press the slide knob, pull up (raise the level of the motor) or push down (lower the level of motor) the motor part to desired height, then leave the slide knob.



注意
WARNING
: 組裝護罩及扇葉前，請勿按高度調校掣，否則馬達部分迅速滑起可能引致受傷。
: Do not press slide knob unless the guards and blade have been assembled because the motor part might quickly slide up and cause injury.

操作方法 / HOW TO USE

時間掣：按此鍵設定以下兩項自動功能
TIMER SWITCH : Press switch to set 2 automatically function;

開機時間：當本機尚未運作，可利用此功能設定自動開機時間。每按鍵一次，可依次設定在1、2、4或8小時後開機，而輕觸式按鍵盤上的LED狀態顯示會亮起綠燈。
TIMER ON : Function for setting an automatically turn on time while the fan hasn't been operated. Each press of switch will set and turn on time in 1 hr., 2 hrs., 4 hrs., or 8 hrs., respectively, and LED status display shows on soft touch switch is green lighting.

關機時間：當本機投入運作後，可利用此功能設定自動關機時間。每按鍵一次，可依次設定在1、2、4或8小時後關機，而輕觸式按鍵盤上的LED狀態顯示會亮起紅燈。
TIMER OFF : Function for setting an automatically turn off time after the fan has been operated. Each press of switch will set as turn off time in 1 hr., 2 hrs., 4 hrs., or 8 hrs., respectively, and LED status display shows on soft touch switch is red lighting.

- 連續按時間掣直至輕觸式按鍵盤上所有LED指示燈熄滅，即可撤銷開/關機時間掣功能。
- Press TIMER switch until all indicator LED on soft touch switch turn off for deactivating TIMER(ON/OFF) function

輕觸式按鍵
SOFT TOUCH SWITCH

遙控器
REMOTE CONTROL

時間掣狀態顯示 TIMER LED STATUS DISPLAY

韻律風狀態顯示 SPEED LED STATUS DISPLAY

風速鍵：每次按下此鍵即可改變風速。
SPEED SWITCH : Each press of this switch changes the fan speed.

低速 → 中速 → 高速

LOW SPEED → MEDIUM SPEED → HIGH SPEED

- 若拔掉插頭，各功能的狀態紀錄會被清除。
- The status of every functions will be cancelled once unplug.

韻律鍵：按下此鍵，本機即透過微電腦自動改變風速，以模仿自然涼風。
RHYTHM SWITCH : Press switch to provide the natural wind by using a micro-computer to automatically change the fan speed

柔弱速 → 適中速 → 強勁速

LOW RHYTHM → MEDIUM RHYTHM → HIGH RHYTHM

- 三種韻律變化
- 3 types of rhythm control
- 每按一次即可改變韻律速度
- Press it again for changing speed
- 按下風速鍵即可取消韻律風控制
- Press speed for cancelling rhythm control.

搖擺鍵：按一下即可啟動搖擺送風功能。再按一下即可停止搖擺送風功能。
SWING SWITCH : Press switch to start fan oscillation. Press it again to stop the oscillation.

開/關鍵：按一下即可啟動風扇（以及搖擺送風功能）。再按一下即可關機。
ON/OFF SWITCH : Press switch to turn on (together with swing function). Press it again to turn off.

警告 / CAUTION

- ① 切勿將手指或其他物件放進護罩內，否則可能損害扇葉或引致受傷。
Do not put fingers or anything into the guard. The blade might be damaged and cause injury.

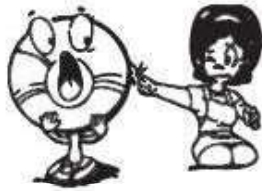

- ② 請勿在下列環境中使用本機：

- 室溫高於45°C
- 極度潮濕的地方
- 靠近火種或容易被水濺濕的地方
- 存放大量燃油、化學品或滿佈塵埃的地方

Do not use the fan in :

- Room temperature over 45 °C
- Very humid area
- Near fire or wet area
- Area containing high amount of oil, chemicals, dust



- ③ 請勿在本機上使用任何噴霧劑，否則塑料零部件可能受損或變形。
Do not apply any kind of spray. Otherwise, the plastic parts might be damaged or deformed.

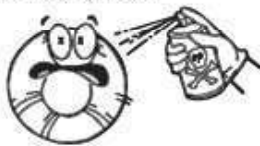

- ④ 請勿在靠近窗簾的位置使用本機，以免造成損壞或意外。

Do not use the fan near curtain because it can cause damage and accidents.



- ⑤ 避免將風扇長時間直吹向人體，特別是病人、嬰兒及長者。
Be careful not to blow the fan wind directly toward body for a long time especially for patient, infants and the elderly.



- ⑥ 若本機電源線受損，不應自行修理，必須送交合資格技術人員或三菱電機維修服務中心修理。
If the supply cord is damaged, it must be replaced by a qualified technician or MITSUBISHI ELECTRIC's Service Centers.



- ⑦ 「遙控器」注意事項
- 請依電極 (+, -) 正確地安裝電池。
 - 請使用同一大小的電池：CR 2025 (3.0 V)。
 - 請把遙控器放置於適當地方。切勿遺失，否則不能遙控本機。
 - 請小心使用遙控器，以免損壞。

Caution for "Remote Control" feature :

- Insert pole (+, -) of battery properly.
- Keep remote control in a proper place. Do not lose it because it controls the operation of the fan.
- Use only a size of battery : CR 2025 (3.0 V)
- Remote control should be used carefully. Do not break it.

8

電線的注意

- 請勿弄破電線
- 請勿重力壓在電線上
- 請勿屈曲電線
- 請勿扭緊電線
- 請勿拉緊電線

以上行為也有機會導致短路或火警。

Power cord caution

- Do not make pinched
 - Do not make overload on
 - Do not bend
 - Do not twist
 - Do not pull on
- It may cause electric shock, and fire.

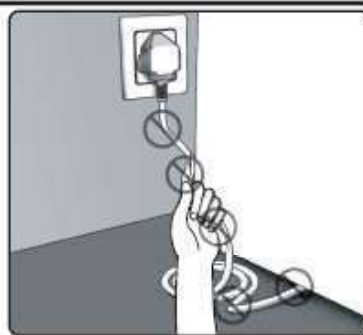

保養須知/CARE INSTRUCTION

1. 在移除保護罩前，必先將電風扇關閉及將電源線拔掉。
2. 為免發生意外，清潔前請拔除插頭，並避免把通電的零部件沾濕。
3. 要清潔零部件（例如：扇葉、支架、底座、護罩等），請用浸過溫水或沾上溫和清潔劑的軟布拭抹，再用軟布抹乾。
4. 切勿使用揮發性化學品（例如：汽油、苯、稀釋劑、清潔噴霧劑、酒精等）或其他化學品（例如：經化學處理的除塵布、鹼性肥皂液、沸水、清潔劑等）清潔本機，以免損害塑料零部件。
5. 假如扇葉積聚大量塵埃，或會令馬達因過熱或震動過度而燒毀或損壞，所以請確保扇葉清潔。
6. 兒童應在成人陪同下使用本機，以確保安全。
7. 不論本產品是否正在運作，請指導並確保兒童不會把玩本機，避免發生意外。

1. To prevent accidents, always unplug the fan before cleaning. Also keep electrical parts out of water.
2. Clean the dirty parts (propeller fan, stand, base, guard, etc.) by using soft cloth, soaked and damped in warm water or mild detergent then wipe dry with soft cloth.
3. Do not use volatile chemicals (gasoline, benzene, thinner, spray cleaner, alcohol, etc.) or other chemicals (treated dust cloths, alkaline soap solutions, boiling water, cleaner, etc.) for cleaning because all of these can damage the plastic parts.
4. If a large amount of dust collects on the propeller fan, it may cause overheating or excessive vibration of the motor. This can lead to burn out and other damages, so be sure to keep the propeller fan clean.
5. The appliance is not intended for use by young children or infirm persons unless they have been adequately supervised by a responsible person to ensure that can use the appliance safely.
6. Young children should be supervised to ensure that do not play with the appliance.



警告/WARNING

- 不論任何情況，不應對產品進行修改，產品拆卸及維修必須交由專業技術人員負責（以免引起火警、觸電或受傷）。如有疑問，請向三菱電機經銷商或維修服務中心查詢。
- Disassembly and repair should not be done unless carrying by a specialized technician (cause of fire, electric shock and injury). Please consult your MITSUBISHI ELECTRIC dealer or service center.



掛牆電風扇 ELECTRIC WALL FAN

型號 / MODEL :

W16-G□, W16-G□-P

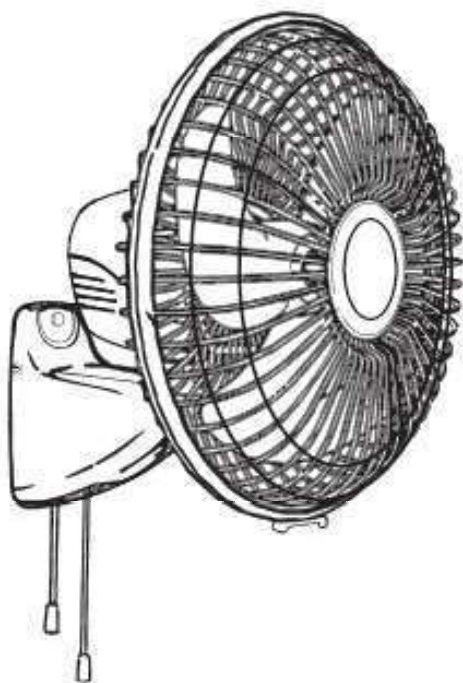

W16-R□, W16-R□-P

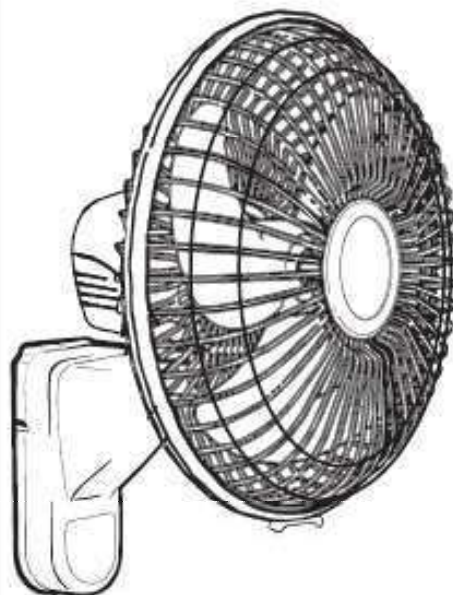

註：□乃生產年份的代表字母
REMARK：□ IS THE ALPHABET OF PRODUCTION YEAR

安裝及操作前請先細閱本說明書，以確保安全。

FOR SAFETY, PLEASE READ THIS MANUAL PRIOR TO INSTALL AND OPERATING

安裝與組合 / INSTALLATION AND ASSEMBLY

決定電源線長度。把多出的電源線繞在電線槽內，把電源線從左邊或右邊的電源線孔穿出。

Determine the power cord length. Winding the remain power cord on cord core and pass the power cord through the left or right cord hole.

電源線 POWER CORD
電線槽 CORD CORE
電源線孔 CORD HOLE

組裝護罩及扇葉前：
Before assemble the guard and propeller fan

拆下旋鈕及螺帽。
Remove the spinner and SPL nut.

此箭嘴向“上”
This mark is up.

把橫栓對準插槽。
Align the pin and the groove.

橫栓 PIN
插槽 GROOVE

承托件 MOUNT PIECE
螺絲 SCREW
螺帽 KNOB SCREW
馬達回轉軸 ROTOR SHAFT
螺帽 SPL NUT
旋鈕 SPINNER
後護罩 BACK GUARD
扇葉 PROPELLER FAN
護罩夾 GUARD CLIP

① 對準護罩上的標記，然後把前護罩套上。
Align with the mark on the back guard and hang on.

標記 MARK

② 同時使用雙手把前護罩完全套上。
Use both hands to push into place.

③ 扣上護罩夾。
Lock guard clip.

按照安裝表把承托件固定在牆壁上。把風扇掛在承托件上，然後收緊螺帽。

Fix the mount piece to the wall following installation table. Install the fan by hang the fan on mount piece and tighten the knob screw.

安裝表 / INSTALLATION TABLE

型號 Model	距離/Distance	
	A	B
W16-G□	超過 34 厘米	超過 46 厘米
W16-G□-P	More than 34 cm.	More than 46 cm.
W16-R□		
W16-R□-P		

註：□ 乃生產年份的代表字母
REMARK: □ IS THE ALPHABET OF PRODUCTION YEAR

操作方法 / HOW TO USE : W16-R□/R□-P

開/關鍵：按一下即可啓動風扇（以及搖擺送風功能）。再按一下即可關機。

ON/OFF SWITCH : Press switch to turn on (together with swing function). Press it again to turn off.

搖擺鍵：按一下即可啓動搖擺送風功能。再按一下即可停止搖擺送風功能。

SWING SWITCH : Press switch to start fan oscillation. Press it again to stop fan oscillation.

輕觸式按鍵
SOFT TOUCH SWITCH

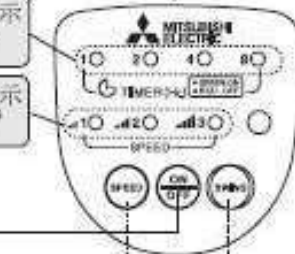

時間狀態顯示
TIMER LED STATUS DISPLAY

韻律風狀態顯示
SPEED LED STATUS DISPLAY

遙控器
REMOTE CONTROL



風速鍵：每次按下此鍵即可改變風速。

SPEED SWITCH :
Each press of this switch changes the fan speed.

低速 → 中速 → 高速

LOW SPEED → MEDIUM SPEED → HIGH SPEED

- 若拔掉插頭，各功能的狀態紀錄會被清除。
- The status of every functions will be cancel if the plug off

韻律鍵：
按下此鍵，本機即透過微電腦自動改變風速，以模仿自然涼風。

RHYTHM SWITCH :
Press switch to provide the natural wind by using a micro-computer to automatically change the fan speed.

- 三種韻律變化
- Rhythm control change 3 step

柔弱速 → 適中速 → 強勁速

LOW RHYTHM → MEDIUM RHYTHM → HIGH RHYTHM

每按一次即可改變韻律速度
Press it again for change step

- 按下SPEED風鍵即可取消韻律風控制。
- Press SPEED switch to deactivate RHYTHM Function.
- 風速指示燈1, 2, 3 將按着自然空氣流通控制度交換發照。
- Wind speed display light can be switched to illuminate among 1, 2, 3 speed level of natural wind control.

時間掣：按此鍵設定以下兩項自動功能

TIMER SWITCH : Press switch to set 2 automatically function;

開機時間：當本機尚未運作，可利用此功能設定自動開機時間。每按鍵一次，可依次設定在1、2、4 或 8 小時後開機，而輕觸式按鍵盤上的LED狀態顯示會亮起綠燈。

TIMER ON
Function for setting an automatically turn on time while the fan hasn't been operated.
Each press of switch will set and turn on time in 1 hr., 2 hrs., 4 hrs., or 8 hrs. respectively, and LED status display shows on soft touch switch is green lighting.

關機時間：當本機投入運作後，可利用此功能設定自動關機時間。每按鍵一次，可依次設定在1、2、4或8小時後關機，而輕觸式按鍵盤上的LED狀態顯示會亮起紅燈。

TIMER OFF
Function for setting an automatically turn off time after the fan has been operated.
Each press of switch will set an turn off time in 1 hr., 2 hrs., 4 hrs. or 8 hrs., respectively, and LED status display shows on soft touch switch is red lighting.

- 連續按時間掣直至輕觸式按鍵盤上所有LED指示燈熄滅，即可撤銷開/關機時間掣功能。
- Press TIMER switch until all indicator LED on soft touch switch turn off for deactivating TIMER(ON/OFF) function

安裝注意事項/INSTALLATION PRECAUTION

1. 必須把承托件牢固地裝在牆壁上，而該處必須堅固，並能承受本機的重量，例如混凝土牆壁或厚度超過 2.3 厘米的木板牆壁。
安裝風扇時，請將風扇掛在墊座上，然後收緊螺樁。
2. 不要把本機橫向、傾斜或倒轉安裝，否則或有鬆脫的危險。必須把本機垂直正面安裝。
3. 若安裝在混凝土牆壁上，請按圖1放進兩顆螺絲膠塞（只適用於混凝土牆），然後用螺絲把承托件固定在牆壁上。

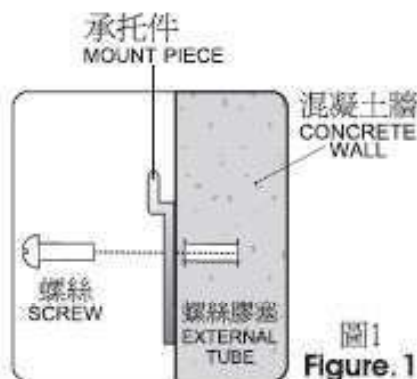

1. Fix the mount piece securely to a part of the wall that is strong enough to hold the fan weight such as a concrete wall or a wood wall thicker than 2.3 cm.,and then install the fan by hang the fan on mount piece and tighten the knob screw.
2. Do not mount the fan horizontally, diagonally or upside down. Otherwise, the fan may fall off. Always install the fan vertically with the mounting face up right.
3. If mounting on the concrete wall, preinsert two plastic "external tubes" (exclusively used for the concrete wall) into the wall, and then fix the mount piece to the wall with screws, referring to the figure 1.

操作方法/ HOW TO USE: W16-G□, W16-G□-P

搖擺控制繩：

拉一下即可啓動搖擺送風。

- 再拉一下即可停止搖擺送風。

SWING ROPE : Pull so that the fan oscillate in the right and left direction.
■ Pull it again to stop fan oscillation.

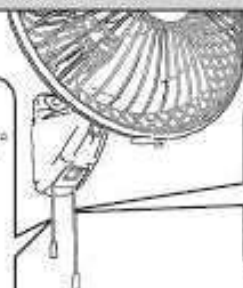

風速控制繩：

拉一下即可啓動風扇；每再拉一下，即可按以下次序改變風速。

SPEED ROPE :

Pull to turn the fan on. Each time of pulling, the fan will operate in order of speed.



送風方向/AIR FLOW DIRECTION

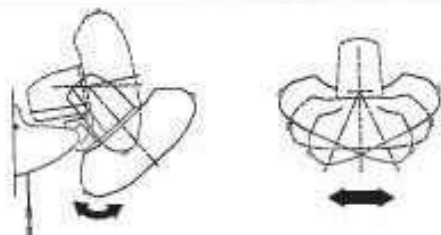

- 本機可供向上、下、左、右調校風向，只需把馬達調校到所需方向即可。

■ The air flow direction can be adjusted up, down, left or right by adjusting the motor as desired.

警告

1. 切勿將手指或其他物件放進護罩內，否則可能損害扇葉或引致受傷。
2. 請勿在本機上使用任何噴霧劑，否則塑料零部件可能受損或變形。
3. 請勿在下列環境中使用本機：極度潮濕的環境；室溫高於45°C；靠近火種或容易被水濺濕的地方；存放大量燃油、化學品或滿佈塵埃的地方。
4. 請勿將衣架或衣物掛在風扇護罩上，亦不要大力拉扯護罩，否則機身可能鬆脫或造成危險。
5. 避免將風扇長時間直吹向人體，特別是病人、嬰兒及長者。
6. 電源插頭必須在伸手可及的地方。若長期不用本機，請拔除電源插頭。
7. 若本機電源線受損，不應自行修理，必須送交合資格技術人員或三菱電機維修服務中心修理。
8. 「遙控器」注意事項
 - 請依電極 (+, -) 正確地安裝電池。
 - 請使用同一大小的電池：CR 2025 (3.0 V)
 - 請把遙控器放置於適當地方。切勿遺失。
 - 請小心使用遙控器，以免損壞。否則不能遙控本機。

CAUTION

1. Do not insert fingers or objects into the guard because propeller fan might be damaged and cause injury.
2. Do not apply any kind of spray. Otherwise, the plastic parts might be damaged or deformed.
3. Do not use the fan in very humid area, place that room temperature is over 45 °C, area where near fire or wet ,or area containing high amount of oil, chemicals, dust.
4. Do not place a cloth hanger or clothes on the guard. In addition, do not pull the guard with a strong force or hang on the guard. Otherwise, the fan may fall off or causes danger.
5. Be careful not to blow the fan wind directly toward body for a long time especially for patient, infants and the elderly.
6. The supply plug must be accessible ,and if the fan is not used for a long time,unplug the fan.
7. If the supply cord of this appliance is damaged, it must only be replaced by a qualified technician or MITSUBISHI SERVICE
8. Caution for "Remote Control" feature :
 - Insert pole (+, -) of battery properly.
 - Use only a size of battery : CR 2025 (3.0 V)
 - Keep remote control in a proper place. Do not lose it because it controls the operation of the fan.
 - Remote control should be used carefully. Do not break it.

保養須知

1. 在移除保護罩前，必先將電風扇關閉及將電源線拔掉。
2. 為免發生意外，清潔前請拔除插頭，並避免把通電的零部件沾濕。
3. 要清潔零部件（例如：扇葉、支架、底座、護罩等），請用浸過溫水或沾上溫和清潔劑的軟布拭抹，再用軟布抹乾。
4. 切勿使用揮發性化學品（例如：汽油、苯、稀釋劑、清潔噴霧劑、酒精等）或其他化學品（例如：經化學處理的除塵布、鹼性肥皂液、沸水、清潔劑等）清潔本機，以免損害塑料零部件。
5. 假如扇葉積聚大量塵埃，或會令馬達因過熱或震動過度而燒毀或損壞，所以請確保扇葉清潔。
6. 兒童應在成人陪同下使用本機，以確保安全。
7. 不論本產品是否正在運作，請指導並確保兒童不會把玩本機，避免發生意外。

CARE INSTRUCTION

1. The fan must switch off from supply mains before removing the guard.
2. To prevent accidents, always unplug the fan before cleaning. Also keep electrical parts out of water.
3. Clean the dirty parts (propeller fan, stand, base, guard, etc.) by using soft cloth, soaked and damped in warm water or mild detergent then wipe dry with soft cloth.
4. Do not use volatile chemicals (gasoline, benzene, thinner, spray cleaner, alcohol, etc.) or other chemicals (treated dust cloths, alkaline soap solutions, boiling water, cleaner, etc.) for cleaning because all of these can damage the plastic parts.
5. If a large amount of dust collects on the propeller fan, it may cause overheating or excessive vibration of the motor. This can lead to burn out and other damages, so be sure to keep the propeller fan clean.
6. This appliance is not intended for use by persons (including children) with reduced physical, sensory or mental capabilities, or lack of experience and knowledge, unless they have been given supervision or instruction concerning use of the appliance by a person responsible for their safety.
7. Children should be supervised to ensure that do not play with the appliance.



警告 / WARNING

- 不論任何情況，不應對產品進行修改，產品拆卸及維修必須交由專業技術人員負責（以免引起火警、觸電或受傷）。如有疑問，請向三菱電機經銷商或維修服務中心查詢。
- Disassembly and repair should not be done unless carrying by a specialized technician (cause of fire, electric shock and injury). Please consult your MITSUBISHI ELECTRIC dealer or service center.

