

For FAQs and more information, please visit:

www.eufylife.com

Owner's Manual

RoboVac 15T (T2115)

T2115 51005001472 V01

Table of Contents

02 Important Safety Instructions

05 About Your RoboVac

What's in the Box

RoboVac Anatomy

Buttons & Indicators

10 Using Your RoboVac

Important Tips Before Use

Preparation

Charge Your RoboVac

Start / Stop Cleaning

Select a Cleaning Mode

Set Time and Scheduled Cleaning

18 Cleaning and Maintenance

Clean the Dust Collector and Filters

Clean the Rolling Brush

Clean the Side Brushes

Replace the Side Brushes

Clean the Sensors and Charging Pins

Clean the Swivel Wheel

23 Troubleshooting

25 Specifications

25 Customer Service

Thank you for purchasing RoboVac 15T. Read all instructions before using this product, and keep it properly for future reference.

Important Safety Instructions

To reduce the risk of injury or damage, read these safety instructions carefully and keep them at hand when setting up, using, and maintaining this device.



WARNING SYMBOLS USED

This is the safety alert symbol. This symbol alerts you to potential hazards that could result in property damage and/or serious bodily harm or death.

- This device can be used by children aged from 8 years and above and persons with reduced physical, sensory or mental capabilities or lack of experience and knowledge if they have been given supervision or instruction concerning use of this device in a safe way and understand the hazards involved.
- Children should be supervised to ensure they do not play with this device.
- Cleaning and maintenance shall not be performed by children without adult supervision.
- This device is only to be used with the power supply unit provided.
- For the purposes of recharging the battery, only use the detachable power supply unit provided with this device.
- The battery must be removed from this device before this device is disposed of. To remove the battery from this device, first remove the screws on the bottom, then remove the main PCB and unscrew the battery cover using a screwdriver. Remove the battery by disconnecting the quick connector.
- The used battery should be placed in a sealed plastic bag and disposed of safely according to local environmental regulations.

- The external flexible cable or cord of the power supply unit cannot be replaced; if the cord is damaged, the power supply unit shall be disposed of.
- This device is for indoor use only.
- This device is not a toy. Do not sit or stand on this device. Small children and pets should be supervised when this device is operating.
- Store and operate this device in room temperature environments only.
- Clean with a cloth dampened with water only.
- Do not use this device to pick up anything that is burning or smoking.
- Do not use this device to pick up spills of bleach, paint, chemicals, or anything wet.
- Before using this device, pick up objects like clothing and loose paper. Lift up cords for blinds or curtains, and move power cords and fragile objects out of the way. If this device passes over a power cord and drags it, an object could be pulled off a table or shelf.
- If the room to be cleaned has a balcony, a physical barrier should be used to prevent access to the balcony and to ensure safe operation.
- Do not place anything on top of this device.
- Be aware that this device moves around on its own. Take care when walking in the area where this device is operating to avoid stepping on it.
- Do not operate this device in areas with exposed electrical outlets on the floor.
- Do not expose the electronics of this device, its battery, or the integrated Charging Base. There are no user-serviceable parts inside.

- Do not use this device on an unfinished, unsealed, waxed or rough floor. It may result in damage to the floor and this device. Use only on hard floor surfaces or low-pile carpet.
- This device has been designed to be used on floors without scratching them. We still recommend that you test this device on a small area of the room to be cleaned to ensure no scratches are made before cleaning the whole room.

Notice

 This symbol on the device or its packaging indicates: Do not dispose of electrical appliances as unsorted municipal waste; use separate collection facilities. Contact your local authority for information regarding the collection systems available. If electrical appliances are disposed of in landfills or dumps, hazardous substances can leak into the groundwater and get into the food chain, damaging your health and well-being. When replacing old appliances with new ones, the retailer is legally obliged to take back your old appliance for disposal at least free of charge.

FCC Statement

This device complies with Part 15 of the FCC Rules. Operation is subject to the following two conditions: (1) This device may not cause harmful interference, and (2) this device must accept any interference received, including interference that may cause undesired operation.

The following importer is the responsible party (for FCC matters only).

Company Name: POWER MOBILE LIFE, LLC

Address: 400 108th Ave NE Ste 400, Bellevue, WA 98004-5541

Telephone: 1-206-383-8247

IC Statement

This device complies with Industry Canada licence-exempt RSS standard(s). Operation is subject to the following two conditions: (1) this device may not cause interference, and (2) this device must accept any interference, including interference that may cause undesired operation of the device.

About Your RoboVac

What's in the Box

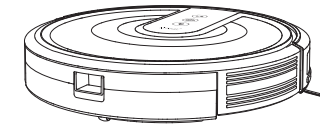

RoboVac 15T

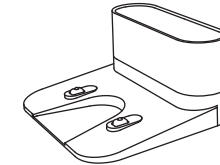

Charging Base



Remote Control
(AAA Battery ×2)

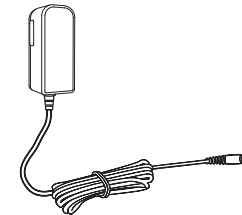

Power Adapter



Cleaning Tool

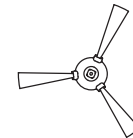

Side Brushes (x4)

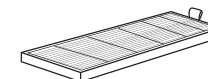

Additional
High-Performance
Filter

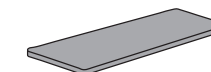

Additional
Foam Filter



Cable Ties (x5)



Owner's Manual &
Other Documents

RoboVac Anatomy

Top & Side

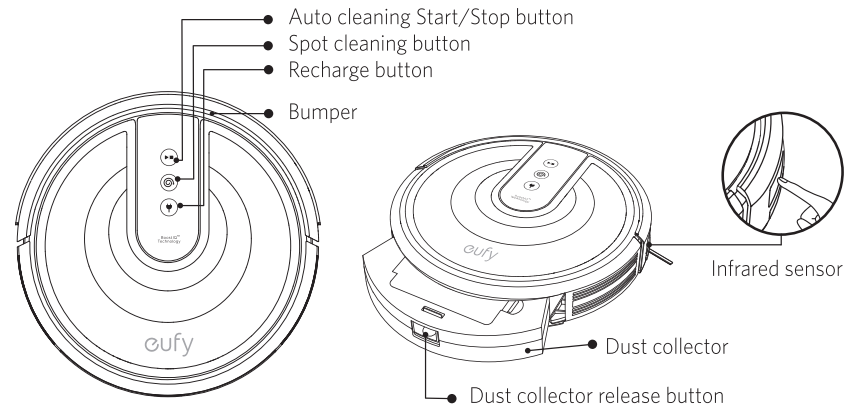

Bottom

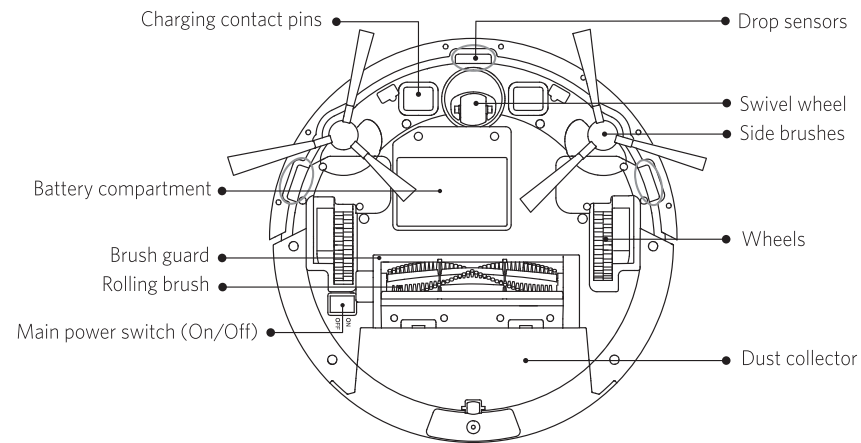

Dust Collector

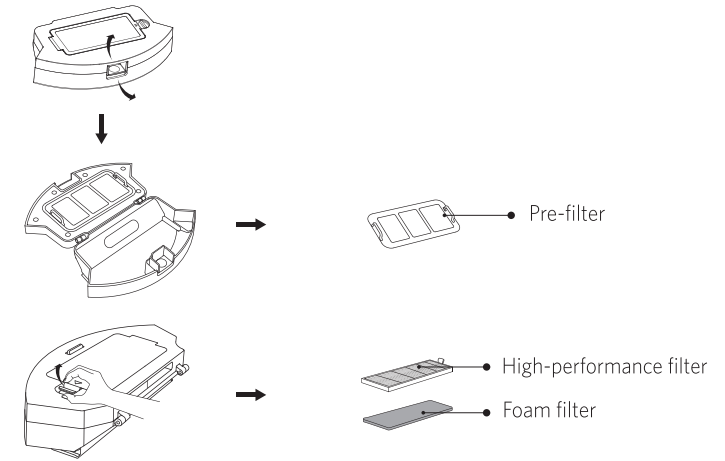

Suction Inlet

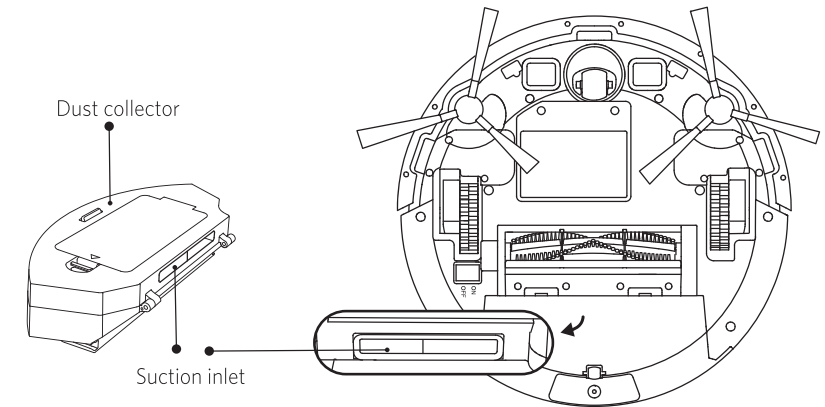

Charging Base

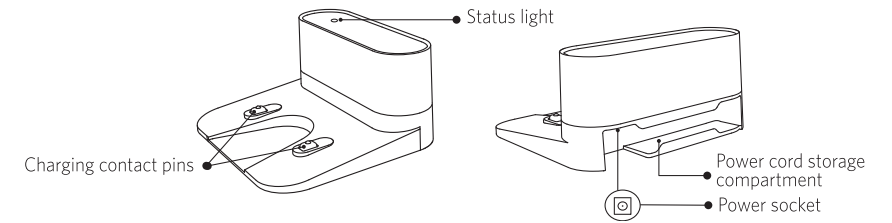

Remote Control

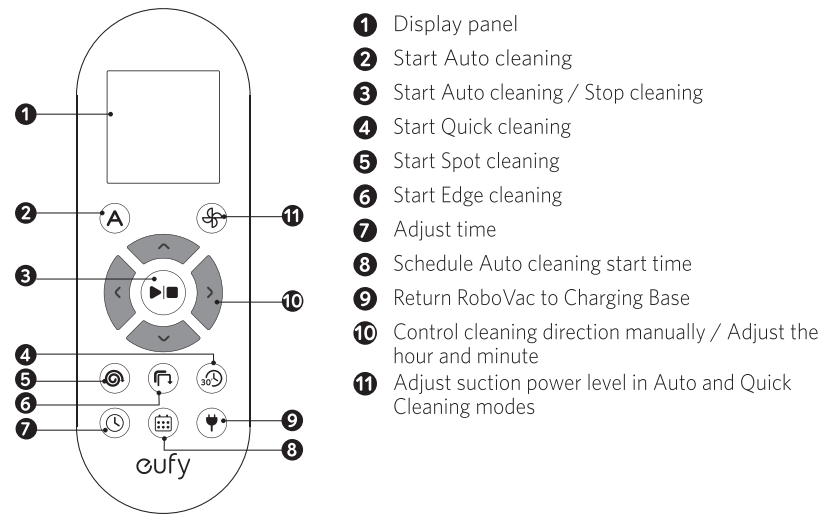



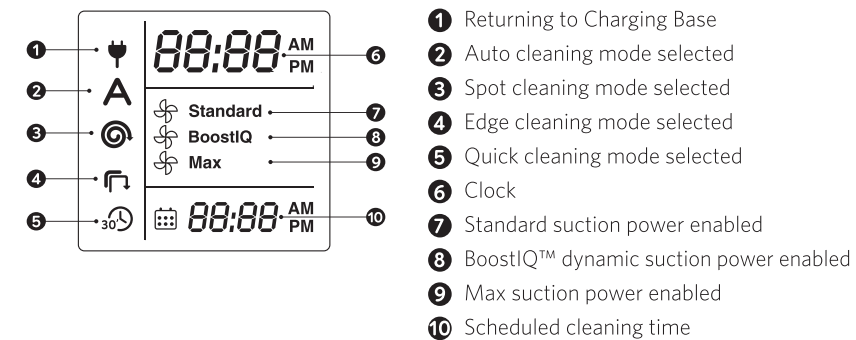

Remote Control Display



 Install 2 AAA batteries before using the remote control for the first time. Make sure the positive and negative ends are facing the correct polarity direction as marked in the battery compartment.

Buttons & Indicators

	Start/Stop Cleaning <ul style="list-style-type: none"> Solid Blue: standby or cleaning Flashing/Solid red: error * Refer to the "Troubleshooting>Error Tone" section in this manual for solutions.
	Spot Cleaning <ul style="list-style-type: none"> Flashing blue: Spot Mode
	Return to Charging Base <ul style="list-style-type: none"> Flashing blue: returning to charging base Flashing orange: low power and returning to charging base Breathing orange (when docked to charging base): charging Solid blue (when docked to charging base): fully charged

 To conserve power, all LED indicators automatically turn off when:

- RoboVac is not docked to the Charging Base and has been inactive for 1 minute;
- RoboVac is fully charged for 1 minute.

Using Your RoboVac

Important Tips Before Use

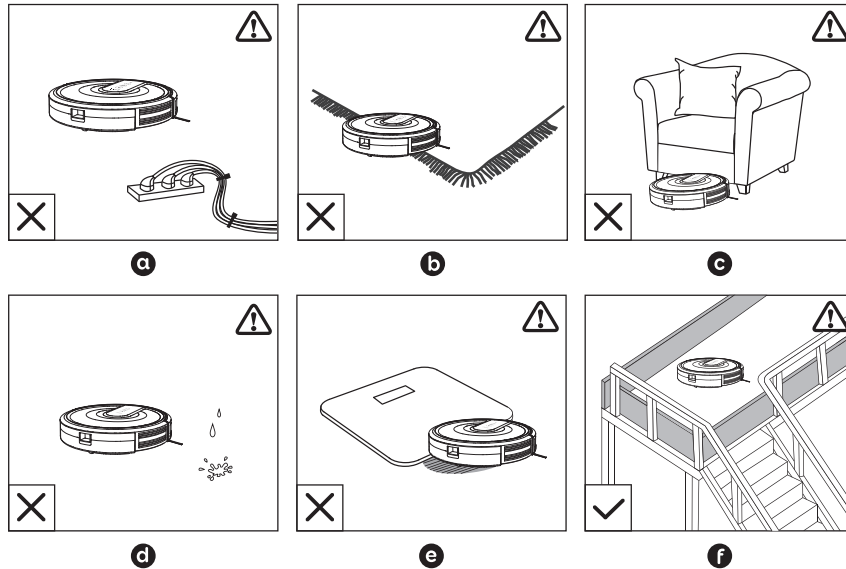

- a** Remove power cords and small objects from the floor that may entangle RoboVac. You can use the supplied cable ties to organize your wires and power cords.
- b** Fold tasseled edges of area rugs underneath to prevent tangling RoboVac. Avoid cleaning very dark-colored high-pile rugs or rugs thicker than 1.02 in/26 mm as they may cause RoboVac to malfunction.
- c** Keep RoboVac away from spaces lower than 2.87 in/73 mm to prevent RoboVac from getting stuck. If necessary, place a physical barrier to block off the problem areas.
- d** Keep RoboVac away from wet areas.
- e** RoboVac may climb on top of objects less than 0.63 in/16 mm in height. Remove these objects if possible.
- f** Anti-drop sensors prevent RoboVac from tumbling down stairs and steep drops. They may work less effectively if dirty or used on reflective/very dark-colored floors. It is recommended to place physical barriers to block off areas where RoboVac may fall.

 Place physical barriers in front of fireplaces and areas that may cause damage to RoboVac if entered.

Preparation

- 1** Install the side brushes before use.

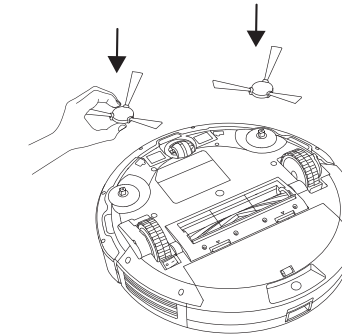

- 2** Turn on the main power switch on the bottom of RoboVac.

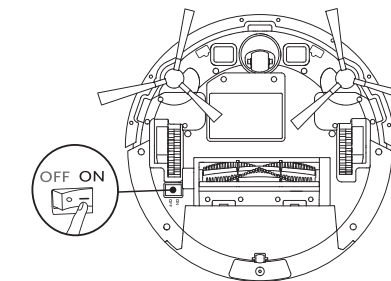

 Remove the sticker next to the power switch, and the foam blocks beside the bumper before use.

- 3** Place the Charging Base on a hard, level surface and against a wall.

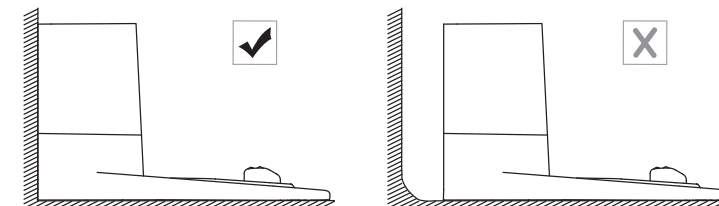

- 4 Remove objects within 3 ft/1 m of the left and right side and within 6 ft/2 m of the front of the Charging Base.

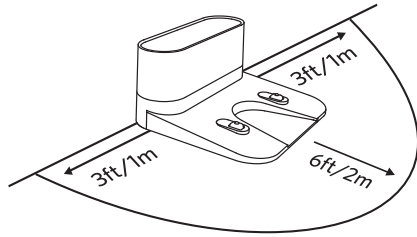

- 5 Connect the round connector of the adapter into the power socket on the Charging Base and the other end into a wall outlet.

- When the Charging Base connects to AC power, the LED indicator on the Charging Base is SOLID WHITE.

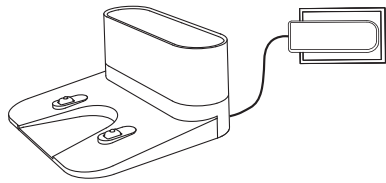

Lightbulb icon:

- Install the Charging Base in a location that RoboVac can easily access. It is recommended to place the Charging Base against a wall, and on a hard-level surface rather than on rugs or carpets.
- Always keep the Charging Base plugged in, otherwise RoboVac will not automatically return to it.

Charge Your RoboVac

- RoboVac has a pre-installed rechargeable battery that has to be fully charged before use.
- RoboVac returns to the Charging Base at the end of a cleaning cycle or when its battery is running low.

Method 1: Attach RoboVac to the Charging Base by aligning its charging pins with the charging pins on the base.

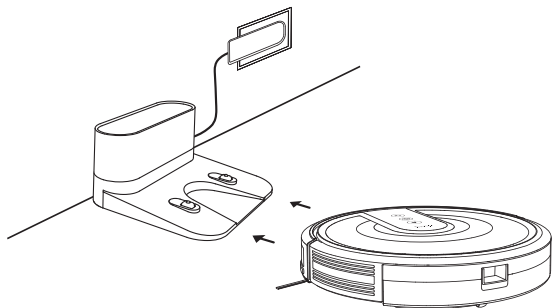

Method 2: Press on RoboVac or on the remote control to return RoboVac to the Charging Base.

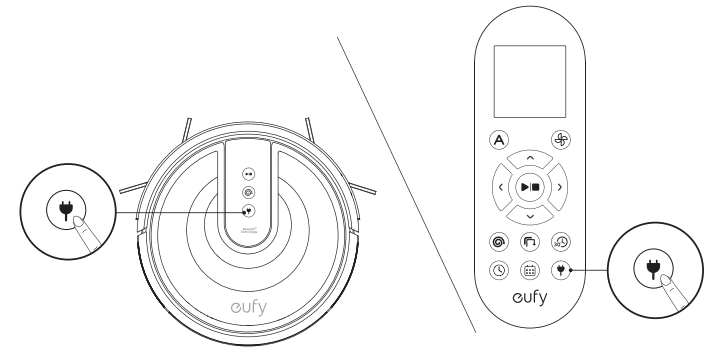

Lightbulb icon: Turn off the main power switch if RoboVac will not be used for a long period of time. To preserve the battery's lifespan, recharge at least once every 6 months.

Start / Stop Cleaning

Menu icon: Make sure the main power switch on the bottom of RoboVac is turned on before use.

1. Press on RoboVac or **A** / on the remote control to start cleaning in Auto Mode.

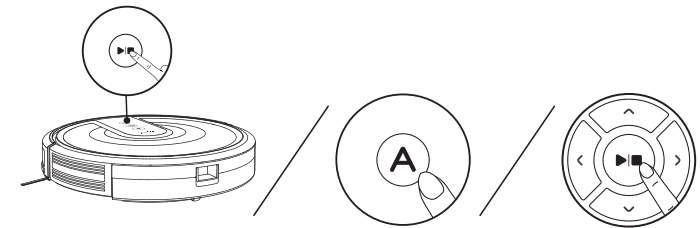

2. Press on RoboVac or on the remote control to stop cleaning.

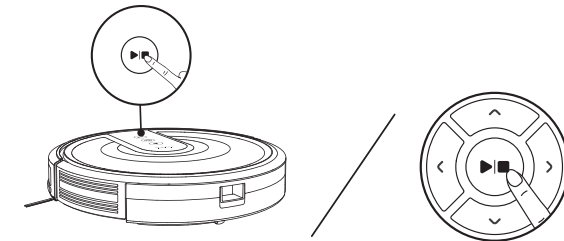



Select a Cleaning Mode

1. Auto cleaning

RoboVac optimizes its cleaning path by selecting different cleaning modes automatically until cleaning is complete. This is the most commonly used cleaning mode.

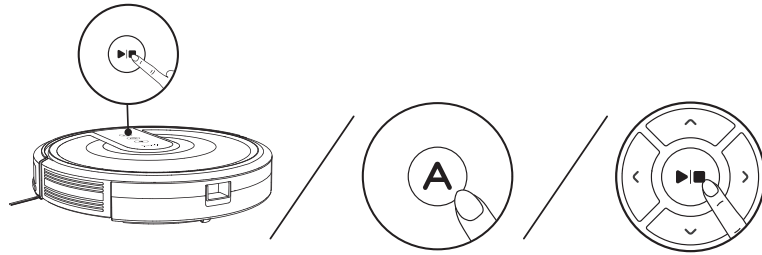
Press **▶|■** on RoboVac or **A / ▶|■** on the remote control to start cleaning in Auto Mode.





-  - RoboVac will return to the Charging Base automatically when the battery level becomes low or when RoboVac finishes cleaning.
- By default, RoboVac starts in Auto cleaning mode when it is turned on.

BoostIQ™ Feature

When the BoostIQ™ feature is enabled, RoboVac will automatically increase the suction power if it detects stronger power is needed to ensure the best clean. BoostIQ™ is ideal for cleaning thicker carpets and hard-to-sweep messes, which will reduce the total cleaning time, but increase the noise level. If the vacuuming noise caused by BoostIQ™ disturbs you, you can disable this feature. This feature only works in Auto and Quick cleaning modes.

In Auto or Quick cleaning mode, press  on the remote control repeatedly to adjust the suction power level.

- The corresponding icon is displayed on the remote control.

Icon	Suction Power Level
 Standard	Standard power
 BoostIQ	Automatically switches between Standard and Enhanced power (default)
 Max	Maximum power

-  When RoboVac starts cleaning in Auto or Quick mode the next time, it will clean according to the suction power level you previously selected.

2. Spot cleaning

RoboVac intensively cleans a specific area in a spiral pattern, useful if there is a concentrated area of dust or debris. In Spot mode, RoboVac will stop cleaning after 2 minutes.

Press  on RoboVac or on the remote control to start cleaning in Spot Mode.

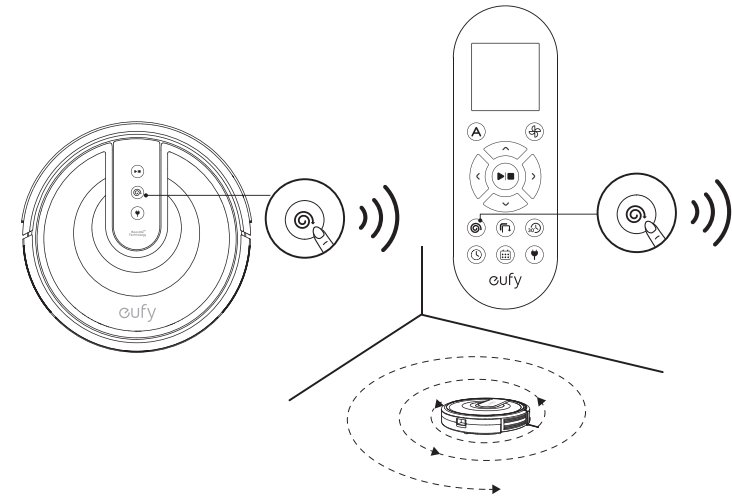

3. Edge cleaning

RoboVac reduces its speed when it detects a wall and then follows the wall to ensure the edge is cleaned thoroughly. In Edge mode, RoboVac will clean for 20 minutes and return to the Charging Base.

Press  on the remote control to start cleaning in Edge Mode.

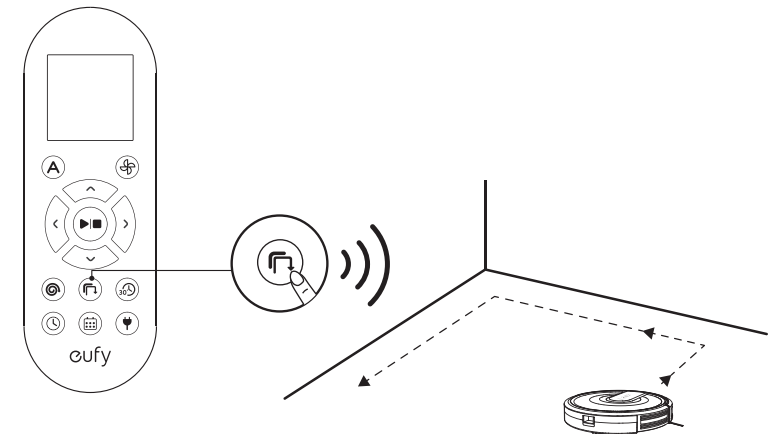

4. Quick cleaning

RoboVac will automatically stop cleaning after 30 minutes and return to the Charging Base in this mode. If any small room or area needs to be cleaned, it is recommended to select this mode to save time and power.

Press  on the remote control to start quick cleaning mode.

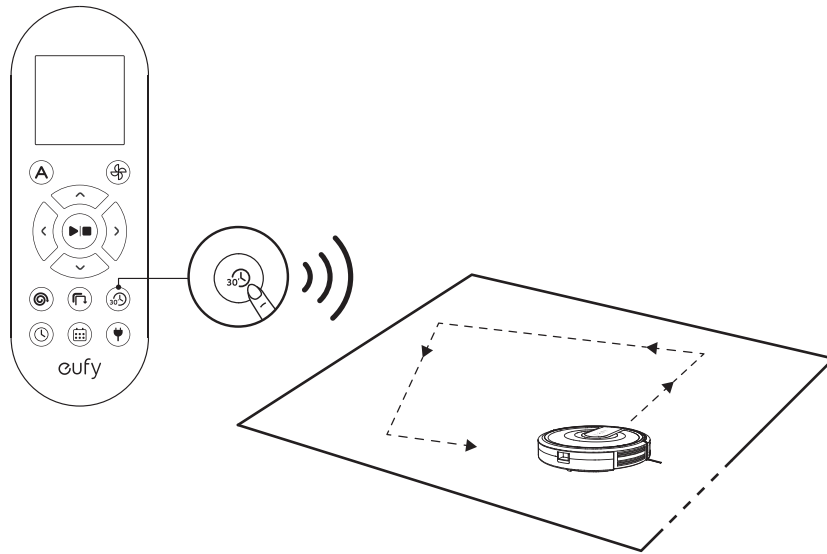

5. Manual cleaning



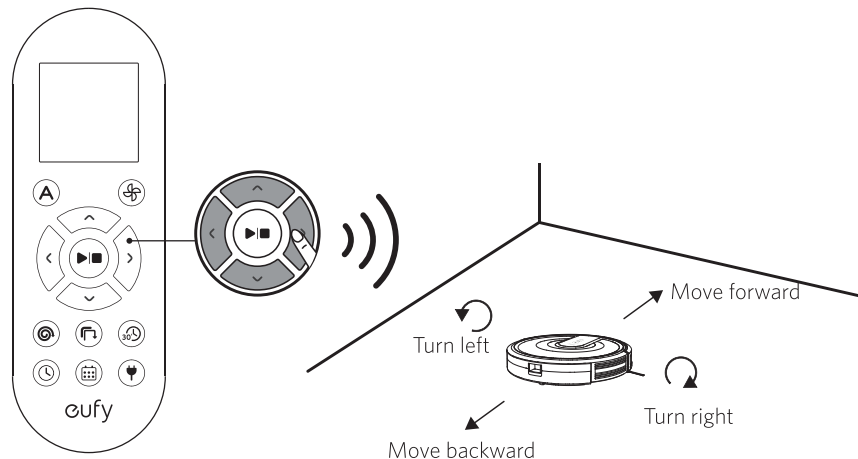

You can direct RoboVac to clean a particular area by using the directional buttons on the remote control.





Set Time and Scheduled Cleaning

Set Time

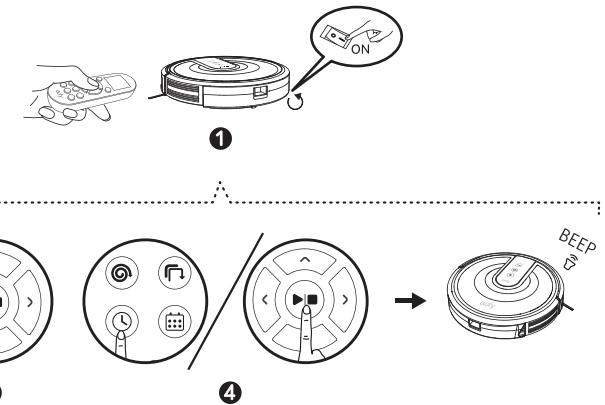

 Make sure the time is set correctly to your local time before setting a scheduled cleaning.

1. Make sure the main power switch on the bottom of RoboVac is turned on.
2. Press  on the remote control. The time will blink on the display.
3. Press   to set the "hour" and "minute".
Note: Make sure AM/PM is set correctly.
4. Press  or  to save the setting. RoboVac will **BEEP ONCE** to indicate the time has been set.





 To ensure the time is set successfully, make sure RoboVac is turned on. You will hear a beep when the time has been set.

Set a Scheduled Cleaning

You can schedule RoboVac to start cleaning at a specified time. To cancel a previously scheduled cleaning, press and hold  for 3 seconds until RoboVac beeps twice and  disappears.

Note: Before setting a scheduled cleaning, make sure the time has been set correctly to your local time; refer to the previous section "Set Time" for how to set the time.

1. Make sure the main power switch on the bottom of RoboVac is turned on.
2. Press  on the remote control.  will blink on the display.

3. Press $\wedge \vee \langle \rangle$ to set the "hour" and "minute".

Note: Make sure AM/PM is set correctly.

4. Press 📅 or ▶ to save the setting. RoboVac will **BEEP ONCE** to indicate the schedule has been set.

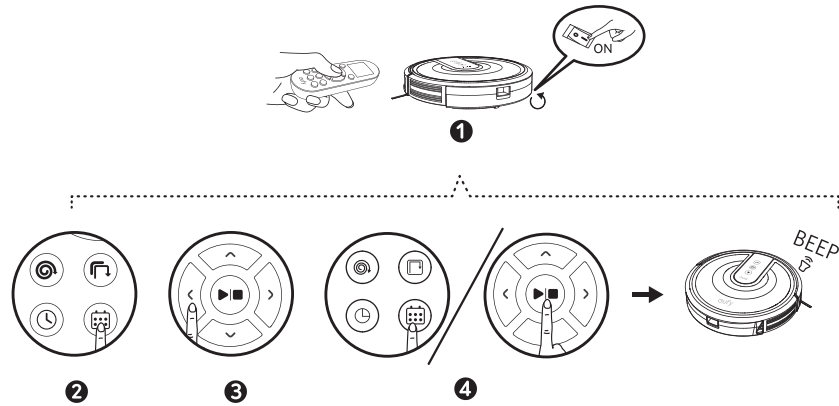

💡 To ensure the schedule is set successfully, make sure RoboVac is turned on. You will hear a beep when the schedule has been set.

Cleaning and Maintenance

For optimal performance, follow the instructions below to clean and maintain RoboVac regularly. The cleaning/replacement frequency will depend on your usage habits of RoboVac.

Recommended cleaning/replacement frequency

RoboVac Part	Cleaning Frequency	Replacement Frequency
Dust Collector	After each use	-
Filters	Once every week	Every 2 months
Rolling Brush	Once every week	Every 6-12 months
Side Brushes	Once every month	Every 3-6 months (or when visibly worn)
Brush Guard	Once every month	Every 3-6 months (or when the silicone rubber strip on the brush guard becomes visibly worn)
Sensors	Once every month	-
Charging Pins	Once every month	-
Swivel Wheel	Once every month	-

Clean the Dust Collector and Filters

- 1 Press the dust collector release button to pull the dust collector out.
- 2 Open and empty the dust collector.

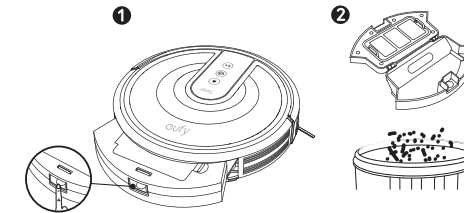

- 3 Remove the pre-filter by pulling the hooks as shown.

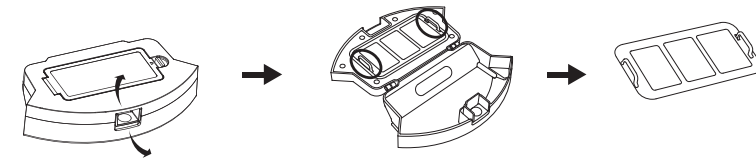

- 4 Take out the foam filter and high-performance filter.

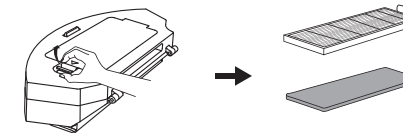

- 5 Clean the dust collector and filters with a vacuum cleaner or a cleaning brush.

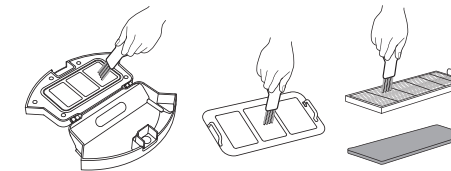

- 6 Put the filters and pre-filter back together in the dust collector.

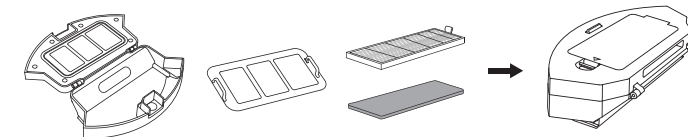

- 7 Push the dust collector back into the main unit.

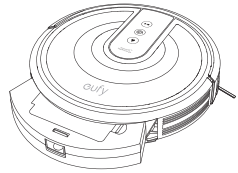

You can wash the dust collector, pre-filter and foam filter with water. Be sure to air-dry them thoroughly before reassembling. Do not wash the high-performance filter with water, as it may damage the filter and reduce the suction power.

Clean the Rolling Brush

- 1 Pull on the release tabs to unlock the brush guard as shown.
- 2 Lift the rolling brush to remove.
- 3 Clean the rolling brush with the provided cleaning tool or a vacuum cleaner.
- 4 Reinstall the rolling brush by inserting the fixed protruding end first and then clicking into place.
- 5 Press down to snap the brush guard into place.

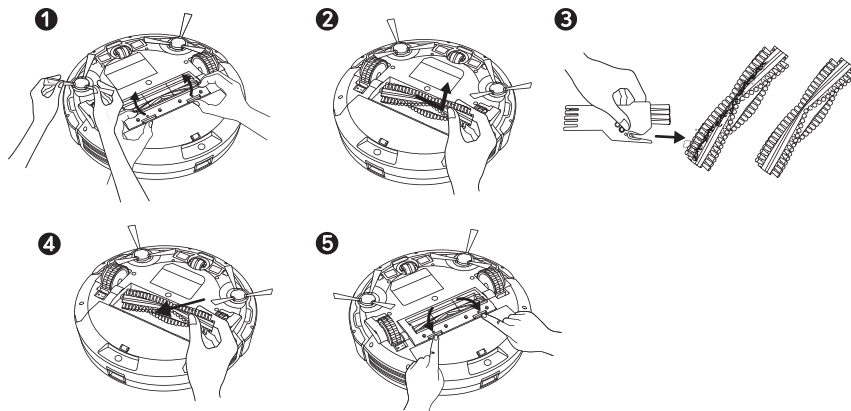

Clean the Side Brushes

Foreign substances, such as hair, can easily get tangled in the side brushes, and dirt may adhere to them. Be sure to clean them regularly.

- 1 Remove the side brushes.

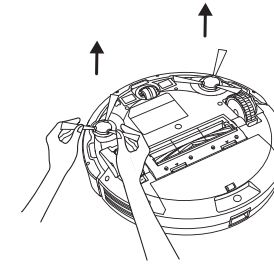

- 2 Carefully unwind and pull off any hair or string that is wrapped between the main unit and the side brushes.
- 3 Use a cloth dampened with warm water to remove dust from the brushes or to gently reshape them.

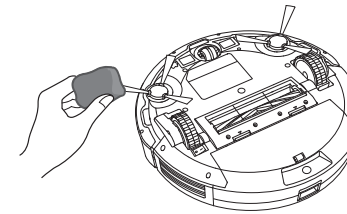

Only use the side brushes when they are completely dry.

Replace the Side Brushes

The side brushes may become bent or damaged after being used for a period of time. Follow the instructions below to replace them.

Pull off the old side brushes and snap the new ones into place.

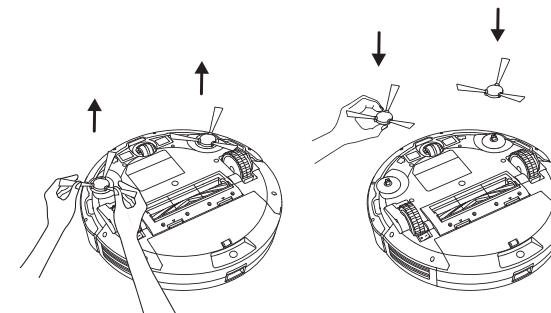

Clean the Sensors and Charging Pins

To maintain the best performance, clean the drop sensors and charging pins regularly.

- Dust off the drop sensors and charging contact pins using a cloth or cleaning brush.

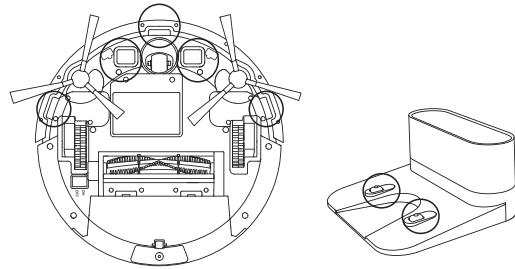

Clean the Swivel Wheel

Hair or dust particles can easily get entangled in the swivel wheel. Be sure to clean the swivel wheel periodically and as needed.

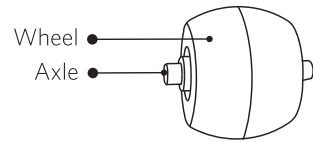

- 1 Pull out the swivel wheel.

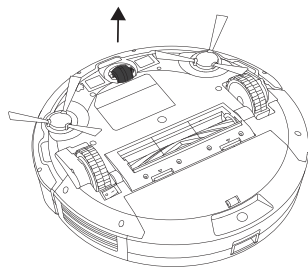

- 2 Clean any hair or debris wrapped around the wheel or entangled inside the wheel cavity.
- 3 Reinstall the wheel and push in until it clicks into place.

- You can clean the swivel wheel with water.
- Use the swivel wheel only when it is completely dry.

Troubleshooting

Problems	Solutions
RoboVac cannot be activated.	<ul style="list-style-type: none"> • Make sure the main power switch is in the ON position. • Make sure the battery is fully charged. • Replace the batteries (2 AAA) in the remote control. • Make sure the remote control is within range (16 ft/5 m) of RoboVac. • If you still have trouble, turn off the main power switch and then turn it back on.
The remote control does not work.	<ul style="list-style-type: none"> • Replace the batteries in the remote control. • Make sure RoboVac is turned on and fully charged.
RoboVac stops working suddenly.	<ul style="list-style-type: none"> • Check if RoboVac is trapped or stuck on an obstacle. • Check if the battery level is too low. • If you still have trouble, turn off the main power switch, wait for 2 seconds, and then turn it back on.
You cannot schedule cleanings.	<ul style="list-style-type: none"> • Make sure the main power switch on the bottom of RoboVac is turned on. • Make sure the time, time of day (AM/PM), and the scheduled time have been set correctly. • Check if RoboVac's power is too low to start cleaning.
Suction power is weak.	<ul style="list-style-type: none"> • Check if any obstructions are blocking the suction inlet. • Empty the dust collector. • Clean the filters with a vacuum cleaner or a cleaning brush. • Check if the filters are wet due to water or other liquid on the floor. Air-dry the filters completely before use.
RoboVac cannot be charged.	<ul style="list-style-type: none"> • Check if the indicator on the Charging Base lights up. If not, contact the eufy service center to repair or replace the Charging Base. • Dust off the charging contact pins with a dry cloth. • Check if you can hear a beep when RoboVac is docked onto the Charging Base. If not, contact the eufy service center to repair or replace the Charging Base.
RoboVac cannot return to the Charging Base.	<ul style="list-style-type: none"> • Remove objects within 3 ft/1 m to the left and right side and within 6 ft/2 m of the front of the Charging Base. • When RoboVac is in the vicinity of the Charging Base, it will return more quickly. However, if the Charging Base is located far away, RoboVac will need more time to return. Please be patient as it works its way back. • Clean the charging contact pins.
The rolling brush does not rotate.	<ul style="list-style-type: none"> • Clean the rolling brush. • Check if the rolling brush and brush guard have been installed properly.

Problems	Solutions
RoboVac's movements or travel path are abnormal.	<ul style="list-style-type: none"> • Clean the sensors carefully with a dry cloth. • Restart RoboVac by turning the power switch off and on.

Error Tones

When RoboVac is in trouble, it will emit a series of short or long beeps and the red indicator on the  button will be solid or flashing.



Flashing red indicator light



Error Tone	Cause	Solution
One beep	<ul style="list-style-type: none"> • RoboVac is stuck and one of the wheels is not making contact with the floor (hanging in mid-air). • RoboVac may be in an extremely large room and the bumper is not registering obstacles. 	Restart cleaning in a new location.
Two beeps	RoboVac's bumper is stuck.	Tap RoboVac's bumper several times to dislodge any debris that may be trapped underneath.
Three beeps	<ul style="list-style-type: none"> • RoboVac's drop sensors are dirty. • RoboVac is stuck on the ledge of a staircase and cannot reverse. 	<ul style="list-style-type: none"> • Clean the drop sensors gently with a dry cloth. • Place RoboVac in a new location. • Use a physical barrier to block off the problem area.
Four beeps	RoboVac's power level is too low.	Manually charge RoboVac for at least 5 hours.

Solid red indicator light

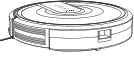
Error Tone	Cause	Solution
One beep	RoboVac's left/right wheel is stuck.	Turn off RoboVac and remove any hair or debris from the left/right wheel.
Two beeps	RoboVac's side brush is stuck.	Turn off RoboVac and remove any hair or debris from the side brush.
Three beeps	RoboVac's suction fan is stuck.	<ul style="list-style-type: none"> • Turn off RoboVac, then remove and empty the dust collector. • Make sure the suction inlet is not blocked by any hair or debris.
Four beeps	RoboVac's rolling brush is stuck.	Turn off RoboVac and remove any hair or debris from the rolling brush.

Specifications

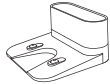
	Product Model	T2115
	Input	19 V  0.6 A
	Battery Voltage	DC 14.4 V
	Power Consumption	25 W
	Battery Type	DC 14.4 V Li-ion 2600 mAh
	Dust Collector Capacity	0.6 L
	Cleaning Time	Max. 100 mins
	Charging Time	300 - 360 mins

	Input	19 V  0.6 A
	Output	19 V  0.6 A

Customer Service

For FAQs and more information, please visit www.eufylife.com.

 Email: support@eufylife.com

 Live chat: www.eufylife.com

 Customer service hotline:

(US) +1 (800) 988 7973 Mon-Fri 9:00am - 5:00pm (PT)

(中国) +86 400 0550 036 周一至周五 9:00 - 17:30

(UK) +44 (0) 1604 936200 Mon-Fri 6:00 - 11:00 (GMT)

(日本) +81 03 4455 7823 月-金 9:00 - 17:00

(DE) +49 (0) 69 9579 7960 Mo-Fr 6:00 - 11:00

 @EufyOfficial  @EufyOfficial  @EufyOfficial  @EufyOfficial

Anker Innovations Limited
Room 1318-19, Hollywood Plaza, 610 Nathan Road, Mongkok, Kowloon, Hong Kong

Consignes de Sécurité

Pour réduire le risque de blessures ou de dommages, lisez attentivement ces consignes de sécurité et gardez-les en main lors de la mise en place, de l'utilisation et de l'entretien de cet appareil.



SYMBOLES D'AVERTISSEMENT UTILISÉS

Voici le symbole d'alerte de sécurité. Ce symbole vous avertit des dangers potentiels pouvant entraîner des dommages matériels et/ou des lésions corporelles graves ou la mort.

- Cet appareil peut être utilisé par des enfants de huit ans et plus, des personnes ayant des handicaps physiques, sensoriels ou mentaux, ou un manque d'expérience et de connaissances, à condition qu'ils soient supervisés ou aient été informés de la manière d'utiliser l'appareil en toute sécurité.
- Ne pas laisser les enfants jouer avec l'appareil.
- L'entretien de l'appareil ne doit pas être effectué par un enfant sans supervision.
- L'appareil ne doit être utilisé qu'avec l'unité d'alimentation électrique fournie avec celui-ci.
- N'utiliser que l'unité d'alimentation fournie avec l'appareil pour en recharger la batterie.
- La batterie doit être retirée de l'appareil avant que celui-ci soit mis au rebut. Pour retirer la batterie, dévisser le couvercle de la batterie à l'aide d'un tournevis. Retirer la batterie en débranchant le connecteur rapide.
- La batterie usagée doit être mise dans un sac hermétique et mise au rebut conformément aux réglementations locales en vigueur.

- Le câble de l'alimentation ne peut être remplacé. S'il est endommagé, l'unité d'alimentation ne pourra plus être utilisée.
- Cet appareil est réservé à une utilisation en intérieur.
- Cet appareil n'est pas un jouet. Ne pas s'asseoir ou se tenir debout dessus. Les petits enfants et les animaux domestiques doivent être surveillés lorsque cet appareil est en marche.
- Conserver et utiliser cet appareil uniquement dans des environnements à température ambiante.
- Ne nettoyer qu'avec un chiffon imbibé d'eau.
- Ne pas utiliser cet appareil pour ramasser quoi que ce soit qui brûle ou fume.
- Ne pas utiliser cet appareil pour nettoyer des flaques d'eau de Javel, de peinture, d'autres produits chimiques ou de quoi que ce soit d'humide.
- Avant d'utiliser cet appareil, ramasser vêtements et papiers, soulever les cordons des stores ou rideaux et mettre les câbles d'alimentation et les objets fragiles hors de portée. Si l'appareil passe par-dessus un câble et l'entraîne avec lui, cela risque de causer des chutes d'objets.
- Si la pièce à nettoyer a un balcon, une barrière physique doit être placée afin d'empêcher l'accès au balcon et d'assurer une utilisation sûre.
- Ne pas placer d'objet sur l'appareil.
- Rester conscient que l'appareil se déplace seul. Faire attention à ne pas marcher sur l'appareil par inadvertance.
- Ne pas utiliser dans des endroits disposant de prises de courant exposées sur le sol.
- Ne pas exposer les composants électroniques de cet appareil, de sa batterie, ou de la station de recharge intégrée. Il n'y a pas de pièces réparables par l'utilisateur.

- Ne pas utiliser sur un sol inachevé, non scellé, ciré ou accidenté au risque d'endommager le sol ou l'appareil. Utiliser uniquement sur des surfaces dures ou sur des tapis à poils courts.
- Cet appareil a été conçu pour être utilisé sur les sols sans les abîmer. Nous vous recommandons tout de même de tester l'appareil sur une petite zone pour vérifier l'absence d'éraflures.

Avertissement

 Ce symbole présent sur le produit ou la boîte signifie que le produit ne doit pas être jeté avec les déchets ménagers, mais doit être déposé dans un centre de collecte approprié pour recyclage. Une mise au rebut et un recyclage adéquats permettent de protéger les ressources naturelles, la santé humaine et l'environnement. Pour plus d'informations sur l'élimination et le recyclage de ce produit, contactez votre mairie, votre service de ramassage des ordures ou le magasin où vous avez acheté ce produit.

Déclaration d'Industrie Canada

Le présent appareil est conforme aux CNR d'Industrie Canada applicables aux appareils radio exempts de licence. L'exploitation est autorisée aux deux conditions suivantes : (1) l'appareil ne doit pas produire de brouillage, et (2) l'utilisateur de l'appareil doit accepter tout brouillage radioélectrique subi, même si le brouillage est susceptible d'en compromettre le fonctionnement.