

★★★★★

INNOVATIVE PRODUKT DES JAHRES

รับประกันคุณภาพ

www.pramiegermany.com

SMART RANGEHOODS

USER INSTRUCTION MANUAL

 **PRÄMIE**

▶ ECO FREUNDLICHE

▶ MODERNE TECHNIK

▶ QUALITÄTSGARANTIE

▶ ประเทศเยอรมัน



Germany Innovation



CONTENT

| | |
|-------------------------------|----|
| Safety Warning..... | 2 |
| licos D..... | 4 |
| Notice..... | 5 |
| Feature..... | 5 |
| Installation..... | 6 |
| Air education setting..... | 19 |
| Use..... | 20 |
| Notice of installation..... | 26 |
| Maintenance..... | 27 |
| Abnormity and Solution..... | 28 |
| Warranty card..... | 29 |
| Environmental Protection..... | 30 |

Safety Warning

- Never let the children operate the machine.
- The cooker hood is for home use only, not suitable for barbecue, roast shop and other commercial purpose.
- The cooker hood and its filter should be clean regularly in order to keep in good working condition.
- Clean the cooker hood according to the instruction manual and keep the unit from danger of burning. If the supply cord is damaged, it must be replaced by the manufacturer, it's service agent or similarly qualified persons in order to avoid a hazard(see 9 part)
- Forbid the direct baking from the gas cooker.
- Please keep the kitchen from a good convection.
- Before connecting this appliance check that the power supply cord is not damaged. A damaged supply cord must be replaced by qualified service personnel only. There is fire risk if cleaning is not carried out in accordance with the instructions.
- There shall be adequate ventilation of the room when the range hood is used at the same time as appliances burning gas or other fuels.
- The air must not be discharged into a flue that is used for exhausting fumes from appliances burning gas or other fuels.
- Regulations concerning the discharge of air have to be fulfilled.
- This appliance if not intended for use by persons(including children)with reduce physical, sensory or mental capabilities, or lack of experience and knowledge, unless they have been given supervision or instruction concerning use of the appliance by a person slide for their safety.
- Children should be supervised to ensure that they do not play with the appliance.
- Do not flambé under the range hood.
- The range hood is not intended to be installed over a hob having more than four hob elements.
- This appliance is not intended for use by persons(including children)with reduced physical, sensory or mental capabilities, or lack of experience and knowledge, unless they have been given supervision or instruction concerning use of the appliance by a person responsible for their safely.
- Children should be supervised to ensure that they do not play with the appliance.
- The air must not be discharged into a flue that is used for exhausting fumes from appliances burning gas or other fuels.
- When the range hood and appliances supplied with energy other than electricity are simultaneously in operation, the negative pressure in the room must not exceed 4 Pa(4x 10⁻⁵ bar)
- CAUTION: Accessible parts may become hot when used with cooking appliance.

Safety Warning

- The light source contained in this luminaire shall only be replaced by the manufacturer or his service agent or a similar qualified person.
- If the external flexible cable or cord of this luminaire is damaged, it shall be exclusively replaced by the manufacturer or his service agent or a similar qualified person in order to avoid a hazard.

Electrical Shock Hazard

- Only plug this unit into a properly earthed outlet. If in doubt seek advice from a suitably qualified engineer.
- Failure to follow these instructions can result in death, fire, or electrical shock.
- The instructions shall state the substance of the following:
 - there shall be adequate ventilation of the room when the range hood is used at the same time as appliances burning gas or other fuels (not applicable to appliances that only discharge the air back into the room);
 - the details concerning the method and frequency of cleaning;
 - there is fire risk if cleaning is not carried out in accordance with The instruction;
 - CAUTION: Accessible parts may become hot when used with cooking appliances;
 - The air must not be discharged into a flue that is used for exhausting fumes from appliances burning gas or other fuels (not applicable to appliances that only discharge the air back into the room);
 - the minimum distance between the supporting surface for the cooking vessels on the hob and the lowest part of the range hood. (When the range vessels on the hob and the lowest part of the range hood. (When the range hood is located above a gas appliance, this distance shall be at least 65 cm.
 - regulations concerning the discharge of air have to be fulfilled.
- The installation instructions for range hoods with accessible metallic enclosures of class II construction shall include details that indicate the location and maximum permitted lengths for any fixing or mounting screw or other fixing device that penetrates into the range hood to attach an accessory such as a fascia or duct fitting.

The correspondence ILCOS D codes of lamp

- **DBR-1.5-S-68**
 - LED lamp-round lamp
 - Max wattage: 1.5 W
 - Voltage range: 12 V
 - Dimensions: 68 mm
- **DBL-1.5-S-120/33**
 - LED lamp-round lamp
 - Max wattage: 1.5 W
 - Voltage range: 12 V
 - Dimensions: length 120 mm/width 33 mm
- **IBT-40-240-E14-25/81**
 - Tungsten filament lamp-clear pear-shaped lamp
 - Max wattage: 40 W
 - Voltage range: 240 V
 - Dimensions: diameter 25 mm/length 81 mm
- **IBB-40-240-E14-35/99**
 - Tungsten filament lamp-clear pear-shaped lamp
 - Max wattage: 40 W
 - Voltage range: 240 V
 - Dimensions: diameter 35 mm/length 99 mm
- **HSGT-28-230-E14-35/99**
 - Tungsten halogen lamp-clear pear-shaped lamp
 - Max wattage: 28 W
 - Voltage range: 230 V
 - Dimensions: diameter 35 mm/length 99 mm
- **DBR-2W-H-35/100**
 - LED lamp-candle lamp
 - Max wattage: 2 W
 - Voltage range: 220 V-240 V
 - Dimensions: diameter 35 mm/height 100 mm
- **LED Lamp E14 5.9W->DB_-5.9-220V/240-E14-35/107**
 - Use type lamp (or use in alternative type lamp) DB_-5.9-220/240-E14-35/107 (ILCOS D code in according to standard IEC 61231)
 - LED lamp-candle
 - Max wattage: 5.9 W
 - Voltage range: 220 V-240 V
 - Dimensions: diameter 35 mm/height 107 mm

NOTICE

1. Thank you for choosing our cooker hood. Please read the instruction manual carefully before use.
2. The installation work must be undertaken by a qualified and competent fitter.
3. The manufacturer disclaims all liability for any damage or injury caused as a result of not following instructions for installation contained in the following text.

The cooker hood is used on 220/240V, 50Hz.
Option(110-120V/60Hz;220V/60Hz)

FEATURE

1. The cooker hood uses high quality materials, and is made with a streamlined design.
2. Equipped with a large power low noise electric motor and centrifugal leaf, it produces strong suction, low noise, non stick grease filter and easy to clean.
3. With the isolated low voltage circuit board control, 12V DC input, the lights are therefore safer.
4. Special wind tunnel construction and oil collector design, free dirt will be absorbed in a second.

Installation

Product one:

- 3.1 The cooker hood should be placed at a distance of 65-75cm(26-30inch)from the cooking surface for the best effect. See the Pic 1.
 - 3.2 Install the hook on a suitable place once the installation height is fixed, and keep it in line. The fixed position of the inside chimney bracket is the place of chimney.
 - 3.3 Fix the outside chimney bracket on the outside chimney, and be sure that the inside chimney can be adjusted the height in in freely as well as fixing the extensible pipe. Afterwards, install the extensible pipe and chimney on the cooker hood. See Pic 3.
 - 3.4 Put the cooker hood on the hook. See Pic 4.
 - 3.5 Adjust the height of the inside chimney to the position of the inside chimney bracket and fix on it by screw, after adjusting the position, fix the body with safety screw, See Pic 5.
- Note:**The two safety vents are positioned on the back casing, with diameter of 6mm.

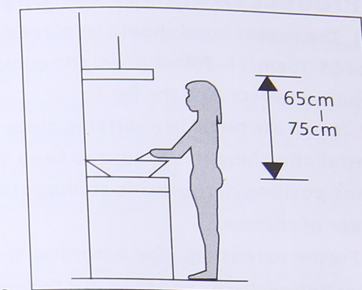

Pic 1

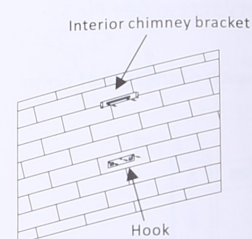

Pic 2

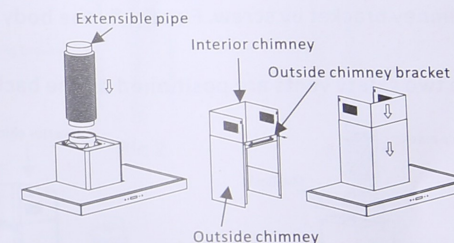

Pic 3

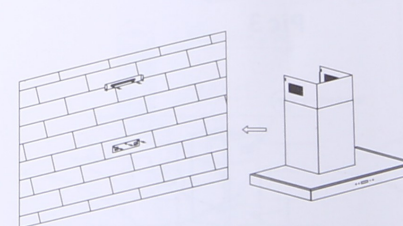

Pic 4

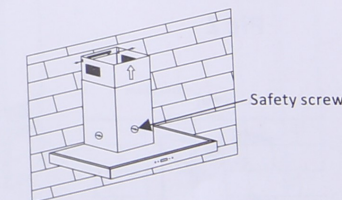

Pic 5

Installation

Product two(glass canopy):

1. The cooker hood should be placed at a distance of 65-75cm(26-30inch)from the cooking surface for the best effect. See the Pic 1.
2. Install the hook on a suitable place once the installation height is fixed, and keep it in line. The fixed position of the inside chimney bracket is the place of chimney.
3. Fix the extensible pipe according to the lead direction and way, and then put the cooker hood on the hook .See Pic 3.
4. Put the glass according to the lead direction and way on the cooker hood ,and then use the screws to fix the glass ,also lead the extensible pipe outside of the room ,mean while adjust the height of the inside chimney to the position of the inside chimney bracket and fix on it by screw, here should be sure the inside chimney can be flexed freely. See Pic 4.
5. Put the two chimneys together onto the cooker hood body, mean while adjust the height of the inside chimney into the suitable height, and fix the inside chimney to the inside chimney bracket by screw. Finally, fix the body with safety screw. See Pic 5.

Note: The two safety vents are positioned on the back casing, with diameter of 6mm.

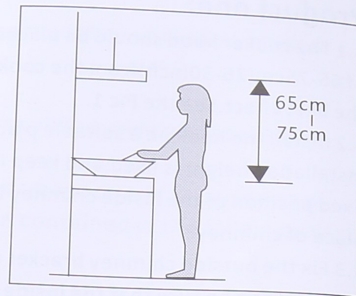

Pic 1

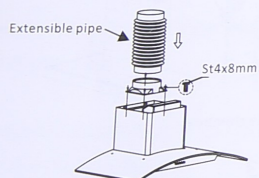

Pic 2

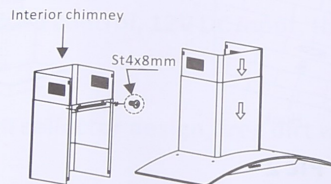

Pic 3

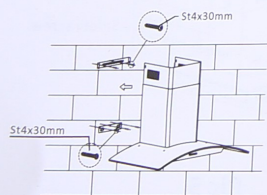

Pic 4

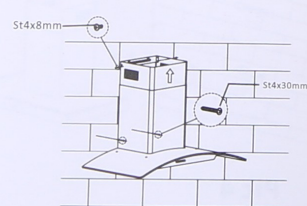

Pic 5

Installation

Product three(island):

1. Make sure of installation position, fix the hanging scaffold at proper position, and check firmness and smoothness of installation. See the pic 1.
2. Adjst to proper height, joint the bracket, install on hanging scaffold. See the pic 2.
3. Fix inside chimney on hanging scaffold, enclose outside chimney on it at proper position, insert hook into bracket to fix outside chimney temporarily. See the pic 3.
4. Fix air outlet in the vent on hood's body, connect extensible pipe with air outlet. See the pic 4.
5. Extend the hose out off hanging scaffold, fix hood's body on bracket. See the pic 5.
6. Detach the hook, move outside chimney downward till reaching hood's body. Pay attention not to strike the glass. See the pic 6.

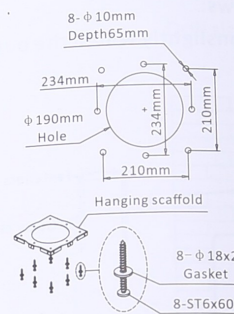

Pic 1

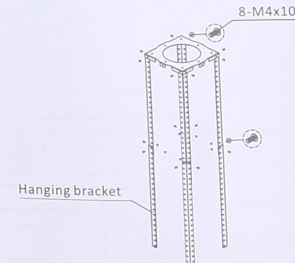

Pic 2

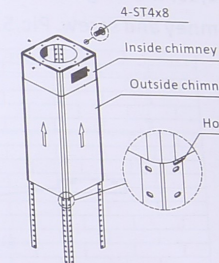

Pic 3

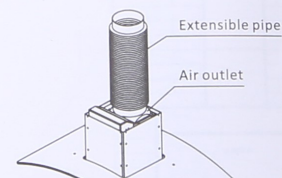

Pic 4

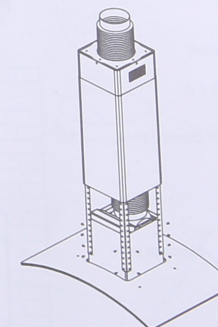

Pic 5

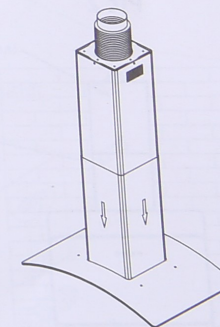

Pic 6

Installation

Product four:

- *The hood can be installed as extractor or recirculation hood
- *The cooker hood should be placed at a distance of 65-75cm (26-30inch) from the cooking surface for the best effect. See Pic.1.
- *Install the hook on a suitable place once the installation height is fixed, and keep it in line.
- *Fix the outside chimney can be adjusted the height in it freely as. See Pic.2
- *Hang the range hood onto the hook plate and fix the chimney with 4 screws.
- *Put on the external chimney and fix it with chimney holder. Pic.3.
- *Finally, fix the external chimney to the wall. As picture 4 shows.
- *Adjust the height of the inner chimney to the desired positionslightly widen the outer chimney and screw. Pic.5.

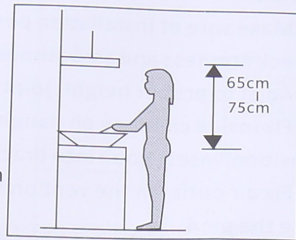

Pic 1

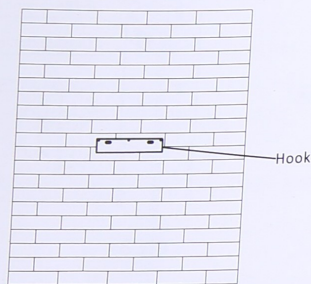

Pic 2

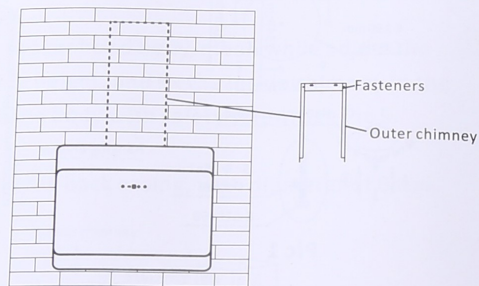

Pic 3

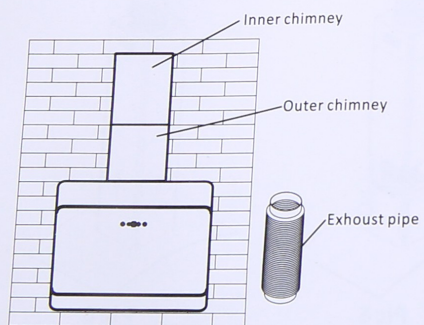

Pic 4

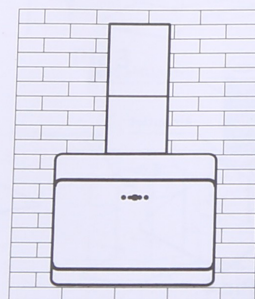

Pic 5

Installation

Product five

Installation Way One:

1. Place at a distance of 65-75cm from the cooking surface, drill 4 holes of $\Phi 8$ mm and depth of 40mm.
2. Insert 4 swelling rubber plug into 4 holes.
3. Fix air outlet into the vent on top of the hood.
4. Open filters, keep the hood in line and tighten the screws.
5. Fix filters.

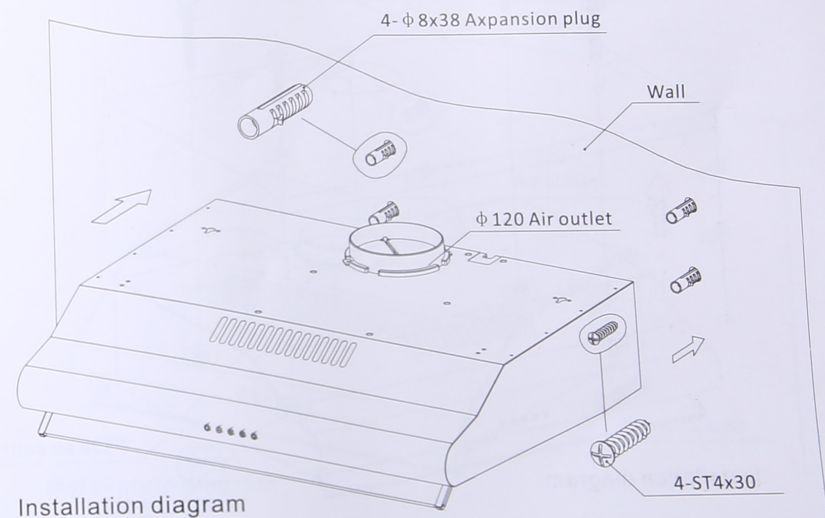
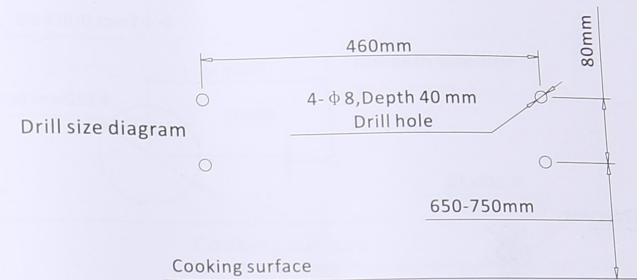

Installation

Product five

Installation Way Two:

- 1 Drill 4 holes of $\Phi 5\text{mm}$ and $\Phi 130\text{mm}$ at the bottom of the hanging cupboard.
2. Fix air outlet into the vent on top of the hood.
3. Open filters, keep the hood in line, insert screws and swelling rubber plug, tighten the screws.
4. Fix filters.

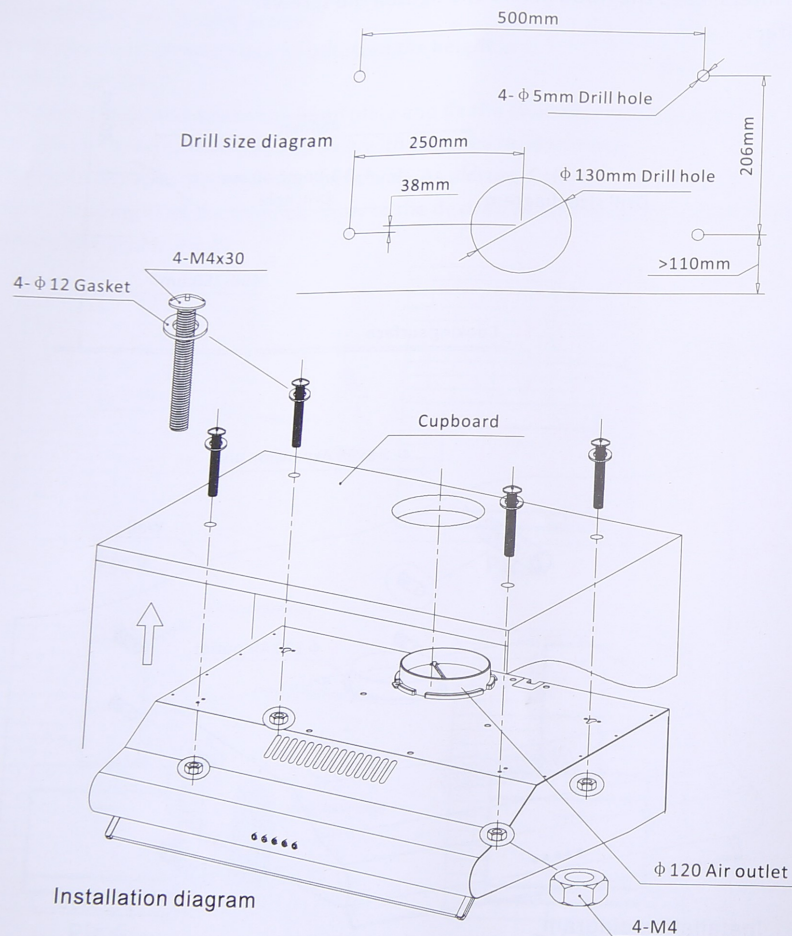

Installation

Product six

Installation Way One:

1. Place at a distance of 65-75cm from the cooking surface, drill 4 holes of $\Phi 8\text{mm}$ and depth of 40mm.
2. Insert 4 swelling rubber plug into 4 holes.
3. Fix air outlet into the vent on top of the hood.
4. Open filters, keep the hood in line and tighten the screws.
5. Fix filters.

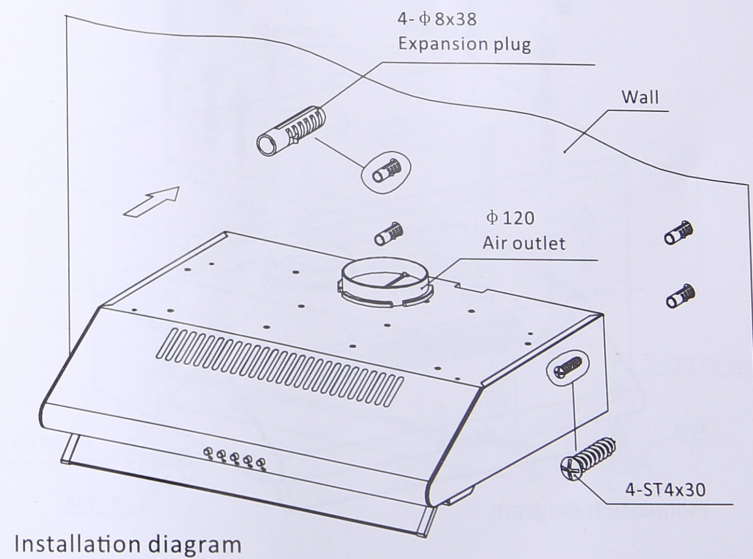
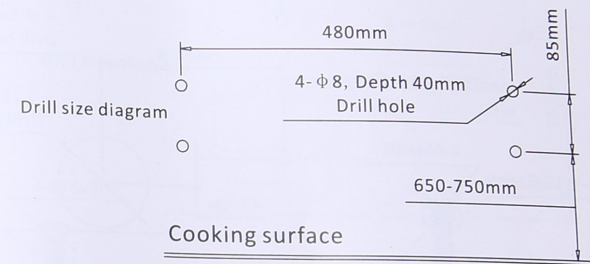

Installation

Product six

Installation Way Two:

1. Drill 4 holes of $\Phi 5\text{mm}$ and $\Phi 130\text{mm}$ at the bottom of the hanging cupboard.
2. Fix air outlet into the vent on top of the hood.
3. Open filters, keep the hood in line, insert screws and swelling rubber plug, tighten the screws.
4. Fix filters.

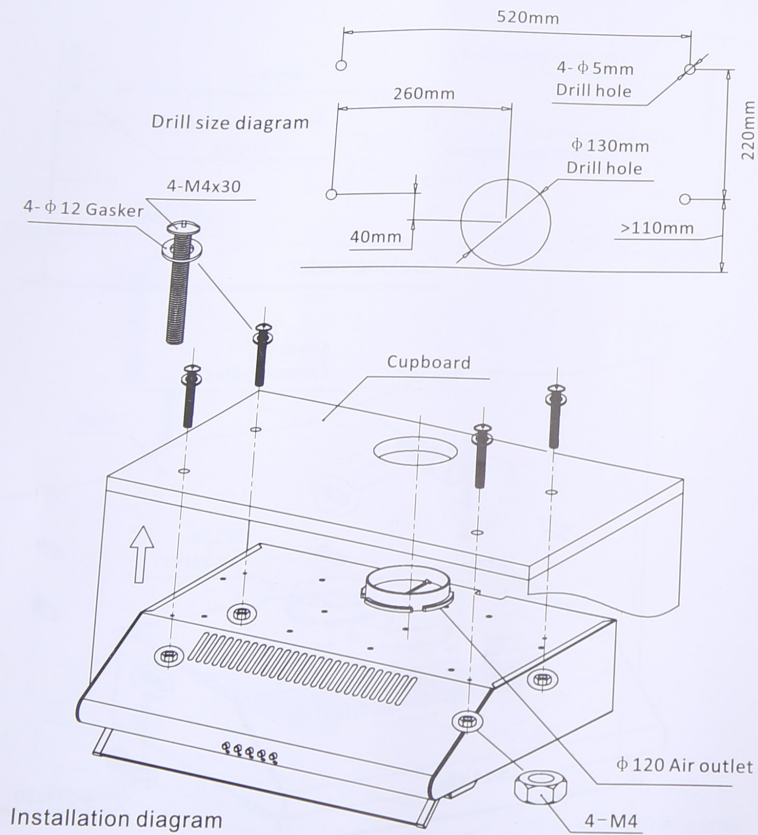

Installation

Product seven:

1. Drill 4 holes of $\Phi 5\text{mm}$ and $\Phi 130\text{mm}$ at the bottom of the hanging cupboard.
2. Fix air outlet into the vent on top of the hood.
3. Open filters, keep the hood in line, insert screws and swelling rubber plug, tighten the screws.
4. Fix filters.

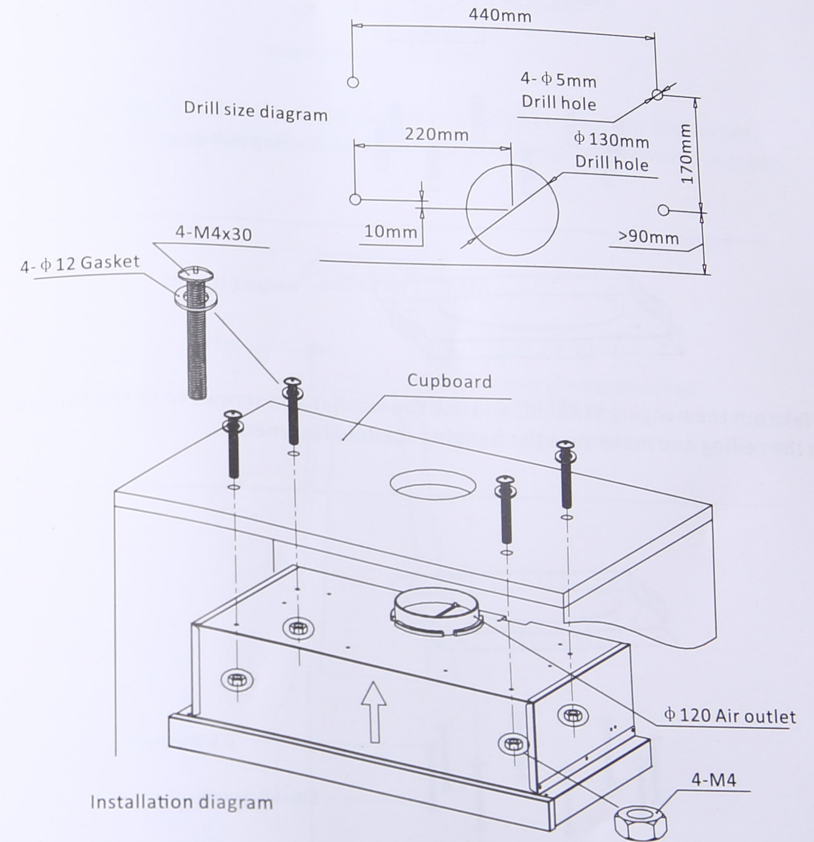

Installation

Installation clue:

1. Put the hanging scaffold at the position you want to install, and draw the holes. After drilling holes, put the 8 pcs of wall-plug into the wall fix it.

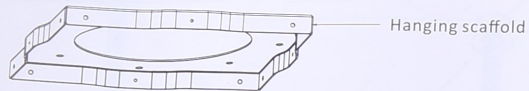
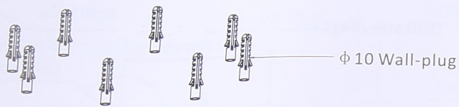
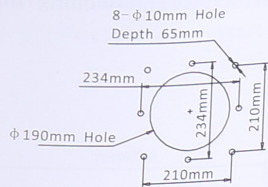

2. Take out the hanging scaffold, and use the washer and screws to fit the hanging scaffold on the ceiling and make sure the hanging scaffold fastened.

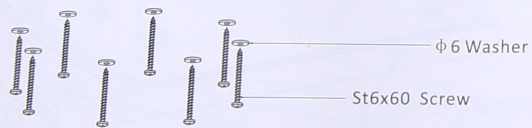
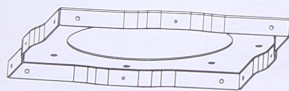

Installation

Installation clue:

3. In the middle of hanging scaffold, socket space is reserved.

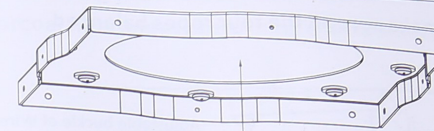

Reservation place for power

4. Take out the cooker hood and put the power cord plug connecting the socket. And then, cover the hanging scaffold with the cover of hanging scaffold. Fix it with 4pcs M4x10 screws.

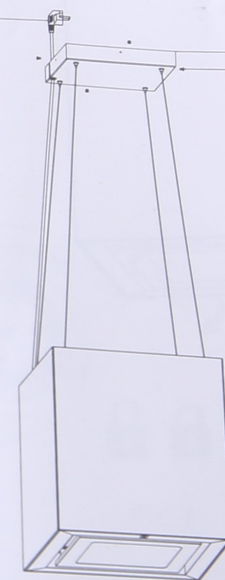

Installation

Installation clue:

5. After hanging the cooker hoods, it may need balance adjustment. First, lift up the cooker hood slightly, and another person press the adjustable buckle of wire rope down and pull out the rope and make sure all the four ropes are balanced.

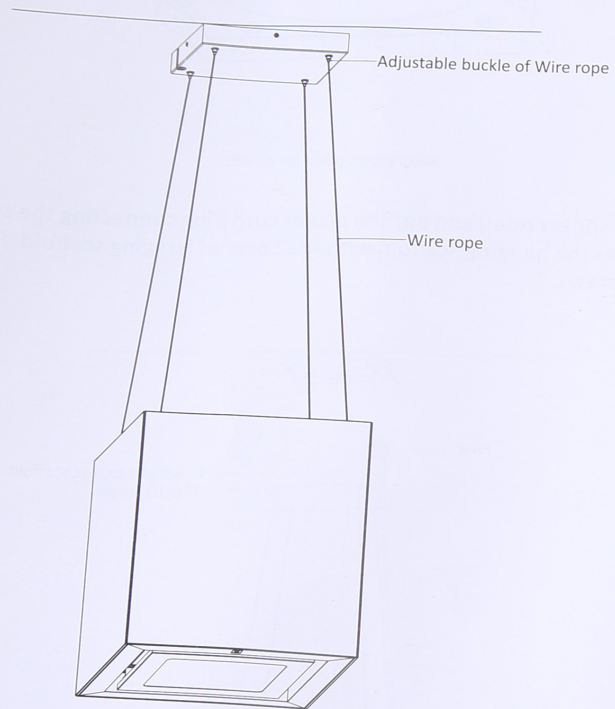

Installation

Installation and removing charcoal filter

Prepare one motor house assembly, then aim the hook in center of charcoal filter at the hook on motor house, turning the charcoal filter clockwise until to limited space. When removing charcoal filter, please returning charcoal filter anticlockwise!

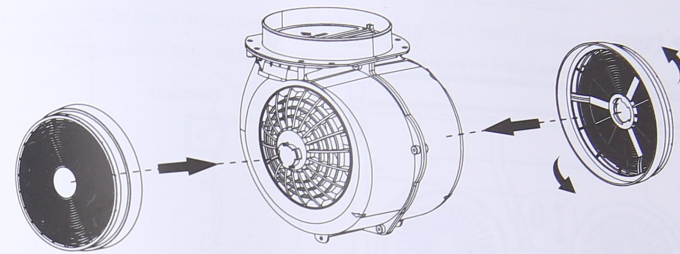

Pic.1

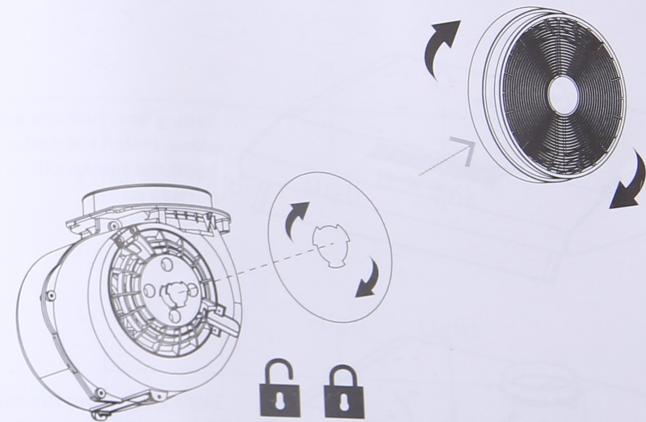

Pic.2

Air education setting

Product one:

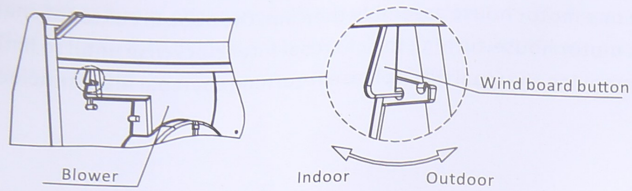

Product two:

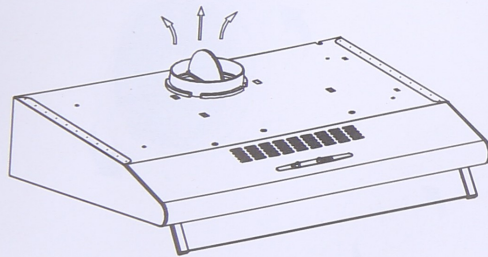
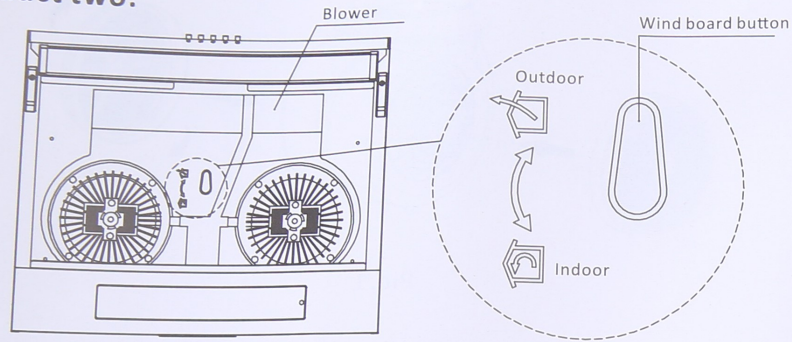

Setting one: turn the adjuster to outdoor place, install the outlet, open the cooker hood, the smoke will be vented from the outside outlet.

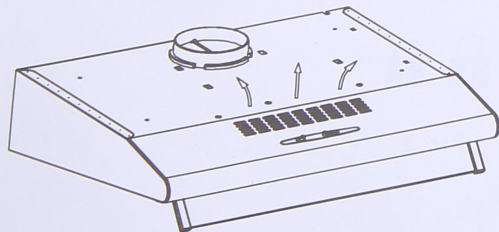

Setting two: turn the adjuster to the indoor place, install the outlet cover, open the cooker hood, the smoke will be vented from the inside vent.

USE (Speed adjustment)

Electronic Button

1. Push the low button, the indicating light 1 on, the buzzer will buzz once, and the motor runs at low speed. Push it again and the motor will stop.
2. Push the middle button, the indicating light 2 on, the buzzer will buzz once, and the motor runs at mid speed. Push it again and the motor will stop.
3. Push the high button, the indicating light 3 on, the buzzer will buzz once, and motor runs on high speed. Push it again and the motor will stop.
4. Push the light button; the indicating light 4 on, and the two lighting lamps will come on. Push it again and the lamps will turn off, with every push the buzzer will buzz one time.

Indicatorlight

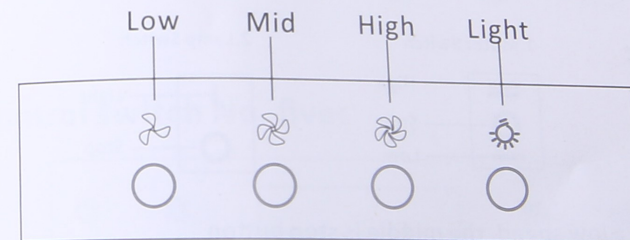
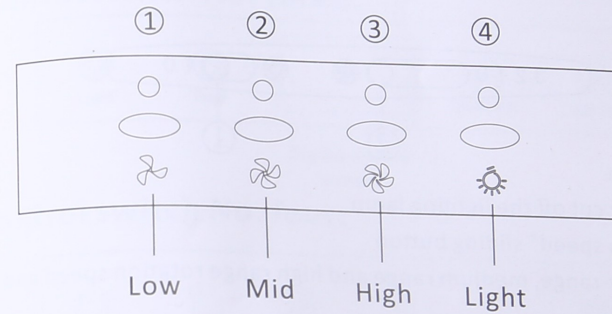

USE(Speed adjustment)

Push button



1. Push stop button, and the motor will stop.
2. Push the Low button, the buzzer will buzz once, and the motor runs at low speed.
3. Push the high button, the buzzer will buzz once, and the motor runs at mid speed.
4. Push the High button, the buzzer will buzz once, and the motor runs at high speed.
5. Push the light button and the two lights will come on. Push it again and the light will turn off.

Push Slide Switch:

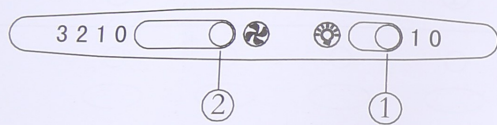

1. "lighting" button
Used to connect or cut off the lighting lamp.
2. "three-range fan speed" sliding button
Used to set the low-range, medium range and high range rotation speed and ventilation of the fan.
The instruction is only suitable for slim hood.

Push Switch:

1. Motor Switch

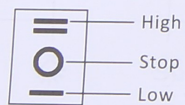

2. Lamp Switch

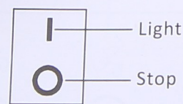

1. Motor switch
Is with a high and a low speed, the middle is stop button
2. Lamp switch
Control the lamp on or off.

USE(Speed adjustment)

Touch control switch No. one:

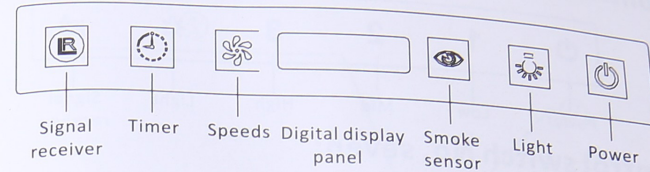

Touch control switch No. two:

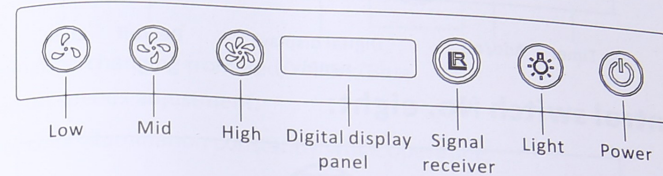

Touch control switch No. three:

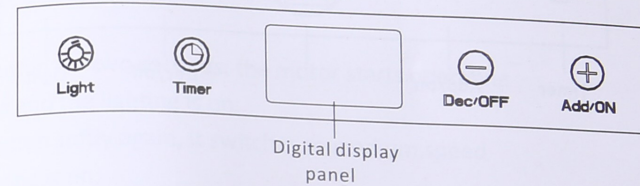

Touch control switch No. four:

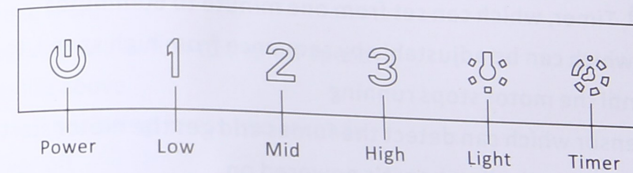

Touch control switch No. five:

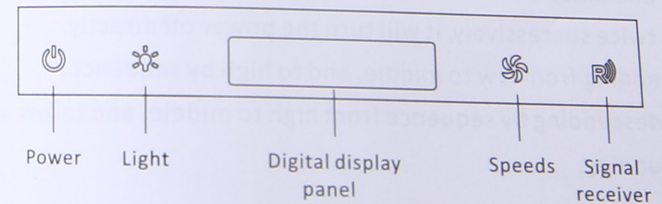

USE(Speed adjustment)

Touch control switch No. six:

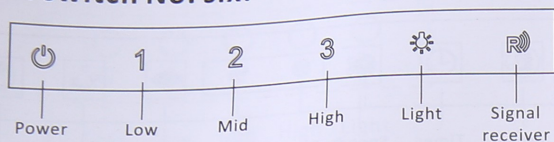

Touch control switch No. seven:

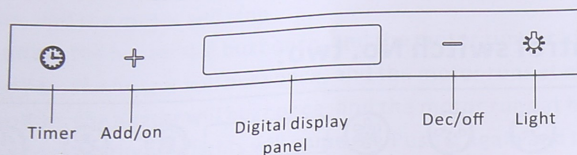

Touch control switch No. eight:

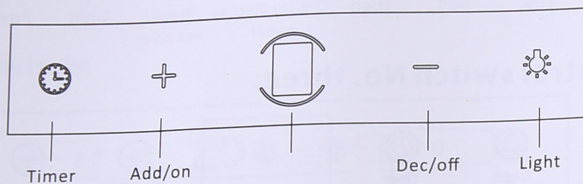

1. [Signal receiver icon] The signal receiver by remote control
2. [Timer icon] [Low icon] [Mid icon] [High icon] Timer, which can set from one minute to 60minutes
3. [Lightbulb icon] Speeds, which can be adjustable by sequence from high speed, to middle and to low until the motor stops running
4. [Smoke sensor icon] Smoke sensor which can detect the fumes and get the motor start to absorb the fumes by automatically when it's powered on.
5. [Lightbulb icon] [Lightbulb icon] [Lightbulb icon] [Lightbulb icon] Light on/off
6. [Power icon] Power off
7. [Power icon] Touch one time, it will take one minute to turn off the power;
Touch twice successively, it will turn the power off directly.
8. [Plus icon] Speed adding from low to middle, and to high by sequence.
9. [Minus icon] Speed descending by sequence from high to middle, and to low until the power stops running.

USE(Speed adjustment)

Touch Switch:

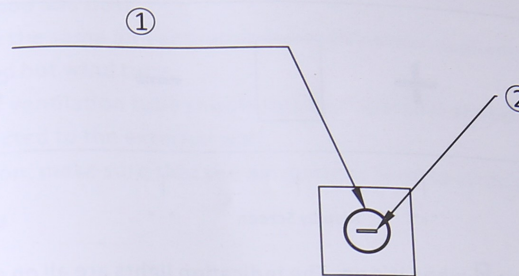

- ① Illumination changing from Red/Yellow/Blue Based on speeds adjustment.
- ② White color illumination constantly while operating.

Functions:

1. press the button for two seconds, the motor starts operating at low speed and the lighting is on;
2. press the button softly again, it switches to medium speed and the lighting is on;
3. press once again, it switches to high speed and the lighting is on;
4. if pressing again, it will switch to the low speed and go cycles like above
5. any condition of operating, press two seconds, it will be power-off.

USE (Speed adjustment)

LED Touch Control Panel

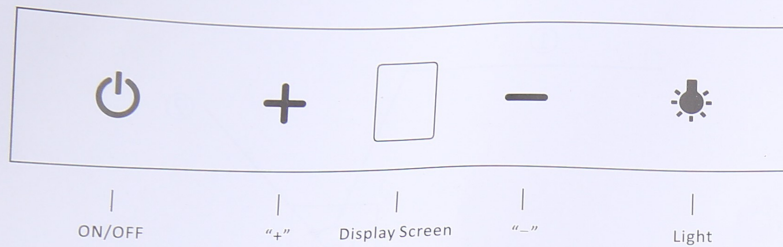

The screen shows **B** when it's on. The indication lights are all on and will be off after 1 second. The buzzer sounds and the light of ON/OFF button turns dark.

Light: Touch the "light" button for 0.5 second, the light turns on; and touch the "light" button again, the light turns off.

ON/OFF (increase speed): Touch the button for 0.5 second, the ON/OFF button light turns on and the display screen shows **1**, and its gear 1. Touch the button "+", the display screen turns to **2** and it's middle speed. Touch the "+" button for the 2nd time, and the display screen turns to **3**, and its highest speed.

Notes: the "+" button turns on for 1 second and then turns off after every touch. When its gear 3, the display doesn't change when the "+" button is touched. The buzzer sounds and the "+" button light turns off after 1 second.

Reduce speed mode:

Touch the "-" button, the display screen shows **2**, and it turns to second speed. Touch the "-" button again, the display screen shows **1**, and it turns to low speed.

Notes: The "-" button turns on for 1 second and then turns off after every touch.

When it's gear 1, the display doesn't change when the "-" button is touched.

The buzzer sounds and the "-" button light turns off after 1 second.

When the range hood is working, touches the "+" and "-" buttons together, it turns to "Delay Off" function (The range hood turns off automatically after 5 min) and the number on the display screen flashes. Touch the ON/OFF button, the range hood turns off and the buzzer sounds.

NOTICE OF INSTALLATION

1. Before installation, please ensure the area is clean to avoid suction of the remaining bits of broken wood and dust.
2. It cannot share the same air ventilation tube with other appliance such as gas tube, warmer tube, and hot wind tube.
3. The bending of ventilation tube should be $\geq 120^\circ$, parallel or above the start point and should be connected to the external wall.
4. After installation, make sure that the extractor is level to avoid grease collection at one end.

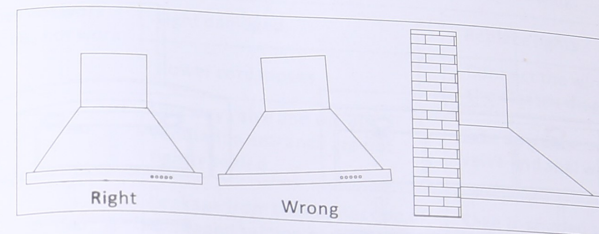

MAINTENANCE

1. The cleaning of the carbon grease filter mesh

The filter mesh is made of high-density stainless steel. Please do not use the corrosive detergent on it. Keeping this filter clean will keep the appliance running correctly. Please strictly follow the guidelines below.

Method 1: Put the mesh into 40-50 c clean water, pour on detergent, and soak for 2-3 mins. Wear gloves and clean with a soft brush. Please do not apply too much pressure, as the mesh is delicate and will damage easy.

Method 2: If instructed to do so, it can be put into a dishwasher, set the temperature at around 60 degrees.

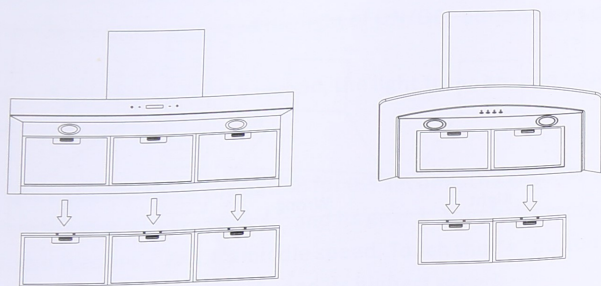

2. Notice of cleaning cooker hood

- A. To protect the main body from corrosion over a long period of time, the cooker hood should be cleaned with hot water plus non corrosive detergent every two months.
- B. Please do not use abrasive detergent or deodorant for it will damage the body.
- C. Keep the motor and other parts free from water, as this will cause damage to the appliance.
- D. Before cleaning the appliance please remember to cut off power.
- E. The carbon filter shouldn't be exposed to heat.
- F. Please don't tear open the fixed bar around the carbon filter.
- G. If the plug or cord is damaged, please replace it with special soft cord.
- H. Cleaning and maintenance is not carried out by children without supervision.

Abnormity and Solution

| Fault | Cause | Solution |
|------------------------------------------|-----------------------------------------------------------------------|-------------------------------------------------------|
| Light on, but motor does not work | The leaf blocked | Get rid of the blocking |
| | The capacitor damaged | Replace capacitor |
| | The motor jammed bearing damaged | Replace motor |
| | The internal with of motor off or a bad smell from the motor | Replace motor |
| Light does not work, motor does not work | Beside the above mentioned, check the following: | |
| | Light damaged | Replace lights |
| | Power cord looses | Connect the wires as per the electric diagram |
| Oil leakage | One way valve and the air ventilation entrance are not tightly sealed | Take down the one way valve and seal with glue |
| | Leakage from the connection of U-shaped section and cover | Take U-shaped section down and seal with soap or pain |
| Shake of the body | The leaf damaged and causes shaking | Replace the leaf |
| | The motor is not tightly hanged | Lock the motor tightly |
| | The body is not tightly hanged | Fixed the body tightly |
| Insufficient suction | The body is not tightly hanged | Readjust the distance |
| | Too much ventilation from open doors or windows | Choose a new place and resemble the machine |
| The machine inclines | The fixing screw not tight enough | Tighten the hanging screw and make it horizontal |
| | The hanging screw not tight enough | Tighten the hanging screw and make it horizontal |

Warranty Card

We will warrant this product free from defects in material and quality for one year from date of purchase. If any problems occur from correct usage, please contact the service department for under warranty service.

This warranty does not cover the following:

- The filter mesh and bulb.
- Commercial use.
- Amendment of the date of manufacture on the rating plate.
- After 12 months from date of purchase.
- Damaged caused to the body by usage of detergent sprayer.
- Pollution made to the led parts, glass parts and S/S parts.
- Incorrect installation, misuse, abuse or neglect.
- Incorrectly fitted to insufficient or unsuitable power.
- Damage caused by foreign object.
- Taken apart or serviced by unauthorized service engineers or replaced with other manufacture's components.

For commercial use the maintenance and free service should be discussed with our authorized agent.

Beyond the 12 month warranty period, the purchaser should pay for charge of components and call out.

In the event of a service call, please provide the warranty card and receipt of date of purchase.

Place of purchase _____

Date of purchase _____

Model _____

Shop stamp _____

ENVIRONMENTAL PROTECTION

Waste electrical products should not be disposed of with household waste. Please recycle where facilities exist. Check with your Local Authority or retailer for recycling advice.

