

材质：双胶纸100克

deerma

Product structure

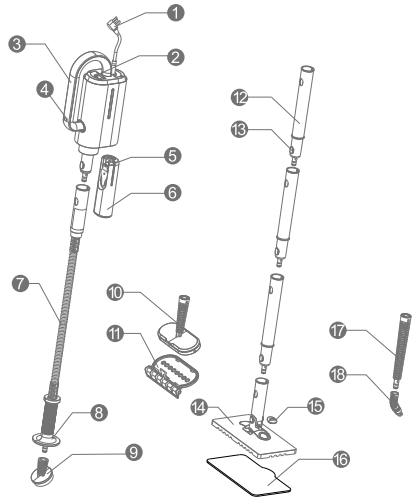

- ① Power cord ② Steam switch ③ Main body handle
- ④ Working indicator ⑤ Water tank cap ⑥ Water tank
- ⑦ Corrugated hose ⑧ Handle ⑨ Sponge nozzle
- ⑩ Squeegee handle ⑪ Squeegee for glass windows/doors ⑫ Mop connecting wand
- ⑬ Wand release button ⑭ Mop head ⑮ Essential oil box cap
- ⑯ Mop ⑰ Brush connector ⑱ Brush head

Circuit diagram

The following diagram is for reference only and subject to any further update without notice. Refer to products if there is any discrepancy. Deerma reserves the right of final interpretation for the content herein.

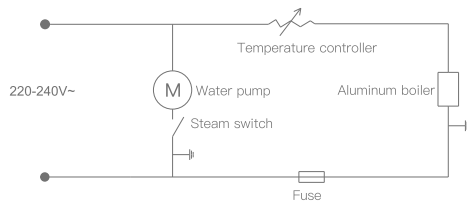

deerma

Troubleshooting

Only a small amount of steam or no steam flows out, though the steam cleaner is in operation.
Cause 1: water is required in the water tank.
Solution: fill the water tank with enough clean water.
Cause 2: the delivery tube in the water tank is blocked.
Solution: clean the accessories of the water tank.

The startup of the main body fails.
Solution: check whether the power cord plug is firmly in the socket or whether the power switch is on.

Water tank leakage
Solution: check whether the water tank or water tank cap is installed in place.

Safety precautions

1. Never allow any child to use the steam cleaner alone or under no supervision of adults.
 2. Never immerse the power cord or plug in water or other liquid to prevent electric shocks.
 3. Keep the power cord and plug intact. Never use them if there is any damage or fault. Send them to the designated maintenance places.
 4. This product is for household use only. Never use it for industrial purposes.
 5. Never power on unless the container is filled with water.
 6. The power supply shall conform to the product provisions of the manufacturer.
 7. Use only the sockets with grounding wires.
 8. Never head steam towards any person, animal or other electrical appliance.
 9. Fill water after unplugging and cutting off power. Unplug after use, before cleaning and during maintenance.
 10. Never fill the water tank with any de-rust agent, deodorant, alcohol or detergent; otherwise damages may be caused.
- Important! Cover the water tank cap tightly after filling water to prevent water leakage.

deerma

deerma

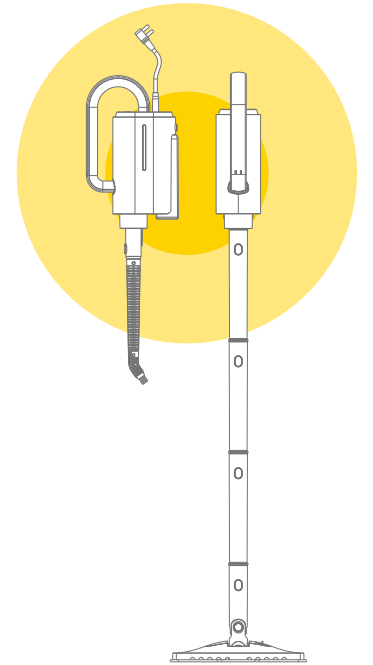

Deerma Multifunctional Steam Cleaner

High temperature steam, multi-function cleaning and decontamination.

The use of high temperature and high pressure steam not only cleans the floor, windows and clothing stains, but also sterilization, keep health and hygiene. Fully equipped with accessories, targeted cleaning every corner of the house. Pure physical cleaning, no chemical hazard, wide range of applications.

DEM-ZQ600/DEM-ZQ610

Read Instruction manual carefully before use



Product parameters

Product name: multi-function steam cleaner
 Model: DEM-ZQ600/DEM-ZQ610
 Rated voltage/frequency: 220-240V-50-60Hz
 Rated power: 1700W Water tank capacity: 230mL
 Net weight: 2.9kg Size: 389*85*180mm
 Steam flow: 20g/min
 Package contents: corrugated hose, squeegee, brush, mop head, main body, mop connecting wand, warranty card, product certificate, operation instruction of storage bag, mop, essential oil, the Instruction Manual, storage bag

Features

1. Advanced

Designed with unique patented technologies. Clean floor, windows, doors and clothes with high-temperature and high-pressure steam. Provided with surface sterilization function, cleaning off dust and bacteria and ensuring satisfactory environment and health. Heating is under automatic control, producing steam continuously for convenient, continuous cleaning. High-pressure steam from the pure water free of any chemical preparation ensures thorough environment protection.

2. Safe

Automatic power cutoff after heating and evaporation of all water in the boiler effectively prevents the heating without water. The high-sensitivity thermostat provides 135°C high-temperature steam for sterilization. A three-prong plug (with a plug as the ground connector) is provided for the grounding of the container and the heating element, ensuring operation safety. The lengthened two-layer insulated power cord is impervious to hot water and dust, assuring security.

3. Durable

The aluminum alloy die-casting boiler with the ultra-thin inner wall can endure high pressure and ensure a long service life. The out shell that is completely made of imported high-quality ABS and PC plastics can provide corrosion resistance and high intensity.

4. Energy-efficiency

The integrated specially-design heating tube and boiler can provide all-around, high-efficiency heating with lower energy consumption. The two-layer shell can effectively prevent heat loss, protecting environment and save energy. Just power on and press the steam switch to obtain immediate, fast heating. After a certain temperature is reached, the steam will spout continuously, providing convenient operation. A complete set of cleaning accessories is provided, and both assembly and disassembly are convenient. These accessories can be adaptably used for cleaning windows, doors, floors and clothes.



Operation

I. Installation of water tank

1. Open the packing box, take out the main body, press the water tank release button and slide the water tank leftwards to take off the water tank;
2. Remove the water tank cap, and fill the water tank with a proper amount of clean water;
3. Cover the water tank cap, and slide the main body along the guide in the left-to-right direction to push it in. The sound of "snap" indicates the success of the installation.

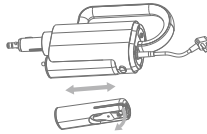

II. Installation and dismantlement of corrugated hose

1. Hold the corrugated hose tail, align the guide slot on the corrugated hose to the guide on the short nozzle on the main body, and insert in place. Ensure the release button on the short nozzle is in the installation hole of the release button at the corrugated hose.
2. For dismantlement, press the release button to remove the corrugated hose from the main body.

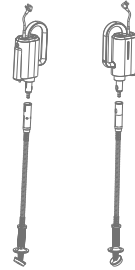

III. Installation and dismantlement of squeegee

1. Hold the tube at the squeegee tail, and align the tube to the cylindrical boss on the short nozzle of the main body to insert it in place; rotate the squeegee by a certain angle to ensure the squeegee is firm on the steam cleaner;
2. For dismantlement, rotate the squeegee reversely by a certain angle, and then dismantle the squeegee from the main body.
3. For cleaning clothes, rotate the buckle on the squeegee for cleaning windows/doors by a certain angle counterclockwise to remove the squeegee.

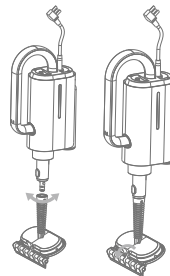

IV. Installation and dismantlement of mop

1. Take out three mop connecting wands; align the guide slot at the tail of one wand to the guide of another wand and insert it in place, and snap the release button of a wand into the release button hole of another wand to assemble the two wands. Assemble the third wand in the same way.



2. After assembling the three wands, hold the mop connecting wand head, align the guide slot of the mop head to the guide on the mop connecting wand and insert the head in place. Ensure the release button of the mop connecting wand is in the button hole of the mop head.
3. Then, hold the mop connecting wand tail, align the guide slot of the wand to the guide on the short nozzle and insert it in place. Ensure the release button of the nozzle is in the button hole of the wand.
4. For dismantlement, press the release button to remove the wand from the main body.

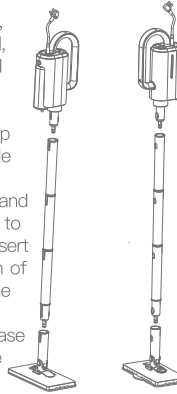

V. Installation and dismantlement of brush

1. Hold the tube at the brush tail, and align it to the cylindrical boss on the short nozzle of the main body to insert it in place; rotate the brush by a certain angle to ensure the squeegee is firm on the main body;
2. For dismantlement, rotate it reversely by a certain angle, and then dismantle the brush from the main body.



Cleaning and maintenance

I. Cleaning of water tank:

1. After removing the water tank from the main body, move away the water tank cap and the sealing plug at the water tank tail to take the delivery tube from the water tank by holding one of its ends.



2. Remove water intaking connector and sealing plug on the delivery tube and then the water intake head. Clean these parts with clean water.

Note: remove the water tank after turning off the steam cleaner or cutting off the power to prevent the heating without water.

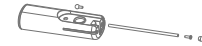

II. Cleaning of mop

Remove the mop cloth from the mop head, clean and dry it naturally.

Note: remove the mop cloth after turning off the steam cleaner or cutting off the power to prevent steam-caused burns.

Precautions

1. The steam cleaner is used for surface cleaner and must be used by referring to the Instruction Manual. Keep the Instruction Manual properly for future reference.
2. Check and ensure the supply voltage of the steam cleaner is consistent with the required working voltage.
3. Cut off power before cleaning, maintaining or storing the steam cleaner. Never pull the power cord forcefully but pull the plug by holding its plastic part.
4. Never immerse the main body in water, approach it to any heating appliance or expose it under direct sunshine to prevent fire.
5. Keep the steam cleaner away from children to prevent accidents.
6. Do not use the steam cleaner, if
 - A. there is any obvious damage or abnormal operation after falling;
 - B. there is any damage of the power cord. In this case, do not turn on the steam cleaner, but send it to the maintenance department designated by Deerma for maintenance.
7. Prevent any long-time operation when no water is in the water tank; otherwise, damages of the boiler and the water pump may be caused.
8. Any damaged power cord must be replaced by the professional personnel from the manufacturer, the corresponding maintenance department or the similar departments to prevent danger.
9. Never allow the steam flow to face towards the devices containing electrical components, e.g. the inner part of the supply box.
10. Any person with any physical defect, sensory disability or mental disorder or any person lacking necessary knowledge or experience must use this product under the supervision/guidance for safe operation and after knowing well about the involved damages. Never allow any child to play with the steam cleaner.
11. Never leave any powered-on steam cleaner unsupervised.
12. Never use any steam cleaner with any falling-caused damage or water leakage.
13. Place the steam cleaner away from any child when it is powered on or during its cooling.
14. High-temperature steam will flow from the position marked with

