

# Alkaline Water Ionizer **User Manual**

(ALPHA-1500/ 1700 Series)



## Table of Contents

1. Electricity Safety Information .....	01
2. Installation Precautions .....	03
3. Precautions While Using .....	05
4. Instructions for Use .....	09
5. Part Name .....	11
6. Components .....	13
7. Under-Sink Installation .....	14
8. Faucet Installation .....	17
9. Water Hose Installation .....	19
10. How to Release Alkaline Water .....	22
11. How to Release Purified Water .....	23
12. How to Release Acidic Water .....	24
13. Energy Saving Mode (Eco Mode) .....	25
14. Volume Control .....	26
15. How to Set Time .....	27
16. Checking Remaining Filter Life .....	28

17. Water Flow Rate Per Minute .....	29
18. How to Set Button Lock .....	30
19. Setting Mode Breakdown .....	31
20. Measuring pH/ Replacing Fuse .....	42
21. Filter Configuration .....	43
22. Replacing Filter .....	44
23. Filter Reset .....	45
24. Forced Operation Function .....	46
25. Troubleshooting .....	47
26. Specifications .....	48
27. Product Warranty .....	49

# I. Electricity Safety Information

- ▶ Please follow the instructions below to prevent any unexpected risk or damage.
- ▶ Safety-related information is divided according to the urgency of the risk and the expected loss.



## Danger

If the instructions are not followed, death or serious disability is expected



## Warning

If the instructions are not followed, significant physical or material harm is expected



## Caution

If the instructions are not followed, minor physical or material harm is expected

- ▶ This symbol represents the operations that may be dangerous and in need of attention.
- ▶ When this symbol is present, instructions must be followed carefully in order to avoid any risk.



## Cause of electric shock and fire

Always clean the power plug before using it by wiping off any remains or dust on it. If either the power cable or the power plug is damaged or if the outlet is loose and can be shaken easily, stop using it and call the maintenance service. Electric shock or short circuit could cause fire.

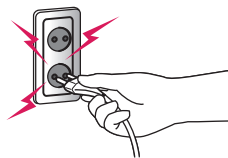

## Do not bend electric cord

Do not damage, modify, bend, pull, or twist the electric cord. It may cause an electric shock, short circuit, or fire.

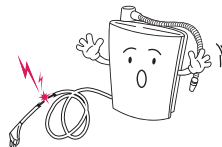



### Cause of electrocution

Do not pull or insert power plug with wet hands. It may cause electrocution

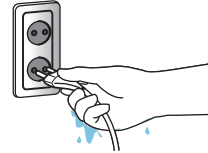

### Use of correct outlet

Please only use an outlet that is rated higher than 10A. Octopus wiring may cause fire due to overheating

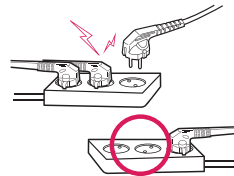

### When repairing product

Unplug power plug when repairing or inspecting product or when exchanging parts. Failure to do so may cause electrocution.

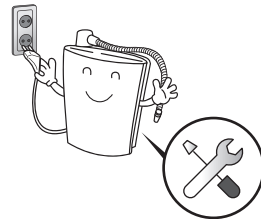

### Do not use warm water!

Do not connect device directly with warm water (warmer than 30°C). It may cause malfunction or accident. Do not use water with high hardness. Do not use water that is not suitable for drinking.



## 2. Installation Precautions



WARNING

### Tap water as source water

It is recommended to use tap water as source water. Do not use underground water, polluted water, and water with high hardness as source water. Do not use warm water as source water. Do not use water unsuitable for drinking (Unsuitable source water based on Waterworks Law).



WARNING

### Prohibition of arbitrary disassembly or renovation

Do not use the power cord after arbitrarily disassembling or renovating it. Do not arbitrarily disassemble or renovate the product. It could become the cause of electric shock or fire.



WARNING

### Install the product away from the wall

Install the product at least 20cm away from the wall. It could become the cause of malfunction.

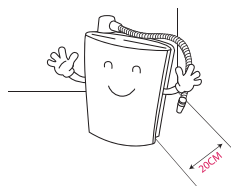

DANGER

### Avoid installing on sloped and shaky areas

Do not apply excess strength or force on the product. Please, install main unit on a level surface. Do not install product in a sloped or shaky area. Dropping the product or collision may cause damage.

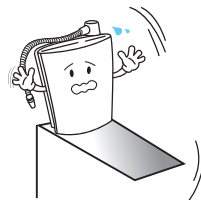



### Cause of electrocution and short circuit

Do not use in humid places such as bathroom. Do not spray water on product or clean product with water. It may cause electrocution and short circuit.



### Do not fold the hose

Make sure the water hose doesn't get tangled or folded, it could become the cause of leakage or short circuit.



### Avoid heated area

Do not install near heating equipment or place candle or lighted cigarette on top of product. Do not install on place in direct contact with fire, exposed to direct sunlight, or near heating equipment such as stove or electric heater. It may cause malfunction or fire.

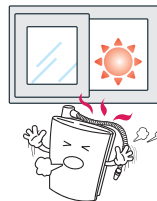

Place this product near a sink and always allow the water to drain into the sink.

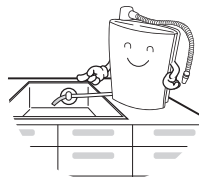

If the unit is not used for a few days, let the water run for 3 ~ 5 minutes before drinking functional water.

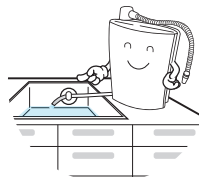

### 3. Precautions While Using



CAUTION

Elderly, people with physical or psychological disabilities, or those who lack experience and knowledge should not be using this product. Children need to be supervised to prevent them from using the product as a toy.



CAUTION

#### In case of water shortage

Please unplug the power cord in case of water shortage. It could become the cause of product malfunction.



DANGER

#### Prohibition of any impact to the product

Do not exert any excessive shock to the product. It could become the cause of electric shock or product malfunction.



DANGER

#### Do not move the product while operating

Please do not move the product while it is still operating. Do not tilt the product over 45 degrees while moving the product. It could become the cause of product malfunction.

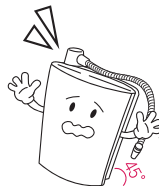





If the unit won't be used for a long time, shut off the valve and unplug the power cord.

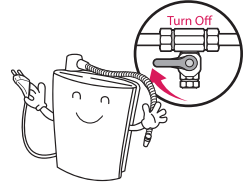

If you hear strange noises, smell a burning odor or see smoke, unplug the power cord immediately and call qualified personnel for service.



Do not place any objects on top of this unit no matter how small they are.



If water leaks out of the unit (other than the hoses) or if the unit is standing in a puddle of water, shut off the water supply, unplug the power cord and contact qualified service personnel for service.

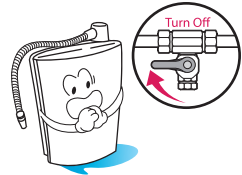

Do not poke or scratch the touch pad or LED display with sharp objects.

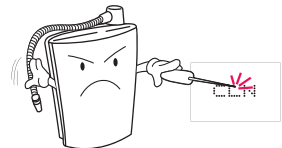



In areas of hard water (calcium scaling present on faucets), notify your service provider and install a cell safe anti-scale prefilter to protect the ionizer from scaling.



### Supply water for goldfish, tropical fish, etc.

Do not use alkaline water or acid water as supply water for fish tank with goldfish, tropical fish, etc.



### Do not insert any sharp objects

Do not insert any sharp wires or drivers into the product. It could become the cause of electric shock or product malfunction.



### When cleaning (electrocution, fire)

When cleaning, do not use benzene, thinner, cleanser, or pesticide. Do not place bowl with water, drug, food, or small metal on top of the product. If it enters inside the product, it may cause electrocution, fire, or malfunction.





- ▶ **When disposing appliances or water filters, please follow the specified procedure.**
  - It becomes the cause of environment pollution.
- ▶ **When installing parts, please use the parts provided from our own company. (Water valves, water hoses, water filters etc.)**
  - Otherwise, it could cause leakage or product malfunction.
- ▶ **When replacing the water filter, please only use the filter from our own company.**
  - It could become the cause of abnormality of water quality or taste.
- ▶ **Do not install the product in locations where there is a risk of freezing in winter.**
- ▶ **The appliance is not to be used by persons (including children) with reduced physical, sensory or mental capabilities, or lack of experience and knowledge, unless they have been given supervision or instruction.**
- ▶ **Children should be supervised not to play with the appliance.**

## 4. Instructions for Use

### Before Use

- ▶ There may be a small amount of residue water on this product since it goes through a water test for quality inspection.
- ▶ Choose a safe place for installation.
- ▶ Connect with tap water.
- ▶ Flush generated water for 3-5 minutes after installation is completed.
- ▶ Prepare a plastic cup or glass container for collecting drinking water. Do not use a metallic container.
- ▶ Do not drink functional water with medication. When taking medication, use "clean H2O" filtered water thirty minutes prior to taking medication as well as with medication. You may resume drinking functional water thirty minutes after taking medication.
- ▶ Always consult your primary care physician before drinking functional water. Only drink a small amount near a neutral pH level for the first week. This will give the body time to adjust to functional water during the detoxification period. See Welcome Guide for full details on getting started.
- ▶ If you notice any negative effects from drinking functional water, stop drinking the functional water immediately and consult your primary care physician about changes in your body's pH level.
- ▶ If you are currently under the care of a primary care physician for an existing condition, consult your primary care physician about how changes in pH and other characteristics of functional water could affect your medical condition.
- ▶ If you suffer from gastric acidity, kidney failure or potassium excretion, you should not drink functional water.
- ▶ Verify the pH levels of the functional water dispensed from this unit on a monthly basis to ensure proper function. This can be done with the supplied reagent drops and a pH color chart.
- ▶ When switching from one pH to another, it is good practice to let the water run for several seconds before using.
- ▶ It is common to drink half your body weight in ounces. For example, if you weigh 180 pounds, it may be wise to drink 90 ounces every day of water per day. This especially applies after you have given your body some time to adjust to the new pH level.

- ▶ The recommended drinking level for functional water is 9.5 pH (+-0.3). It is not recommended to drink functional water above a pH of 10.
- ▶ If you wish to store functional water, use a glass or other non-leaching material with an airtight lid and store it in the refrigerator. Functional water will begin to weaken immediately and will lose most of its benefits after 3 days.
- ▶ Never run hot water through this unit.
- ▶ Never drink acidic water.

---

### **Storage and Management Method After Usage**

- ▶ Make sure the power is off when moving the unit.
- ▶ When cleaning, do not let water enter inside the main unit.
- ▶ Do not block output or bend, twist, or press hose.
- ▶ Use smooth cloth to lightly wipe the surface of main unit.
- ▶ Do not store in hot, humid places.

## 5. Part Name

### <Front Surface>



### <Rear Surface>

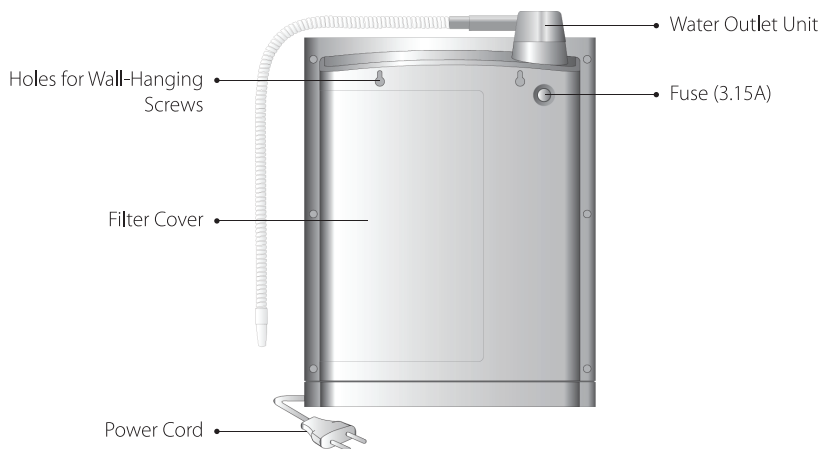

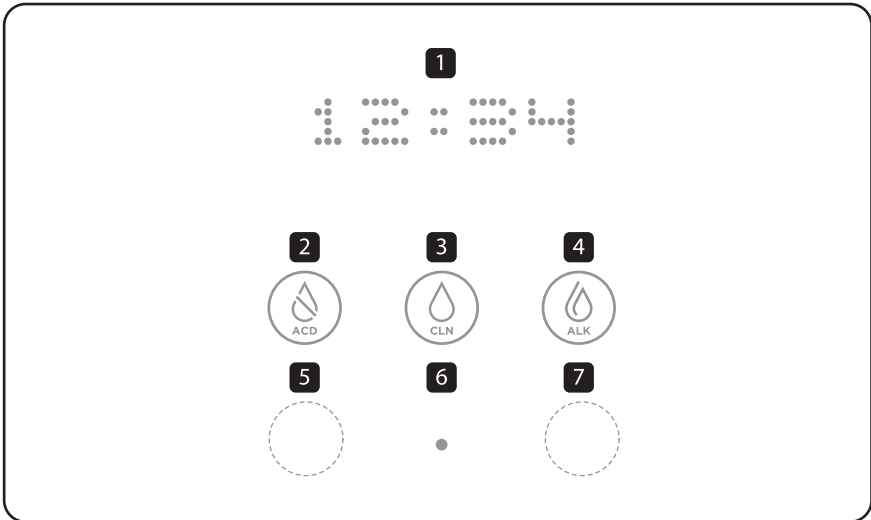

- 1** Display - Standby Clock Mode, Stage Selection Display
- 2** Acidic Water Button (ACD) - Acidic Water Stage Selection  
- 5-Second Touch to Control Volume
- 3** Purified Water Button (CLN) - Purified Water Selection  
- 10-Second Touch to Reset the Filter
- 4** Alkaline Water Button (ALK) - Alkaline Water Stage Selection
- 5** Hidden Button 1 - Time Setting (not lighted on the display)
- 6** ON/OFF Button - Start/Stop Button
- 7** Hidden Button 2 - Check Remaining Filter Amount (not lighted on the display)

## 6. Components

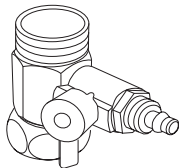

Tap Water Adapter



Dust Filter

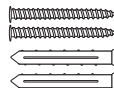

Installation Nails



1/4" Tubing Hose



9mm Drainage Hose

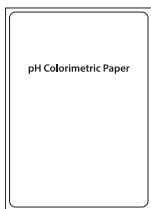

pH Colorimetric Paper

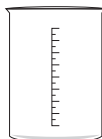

pH Measurement Cup  
20CC



pH Reagent  
5CC



## 7. Under-Sink Installation

<Locate TAP WATER Connection>

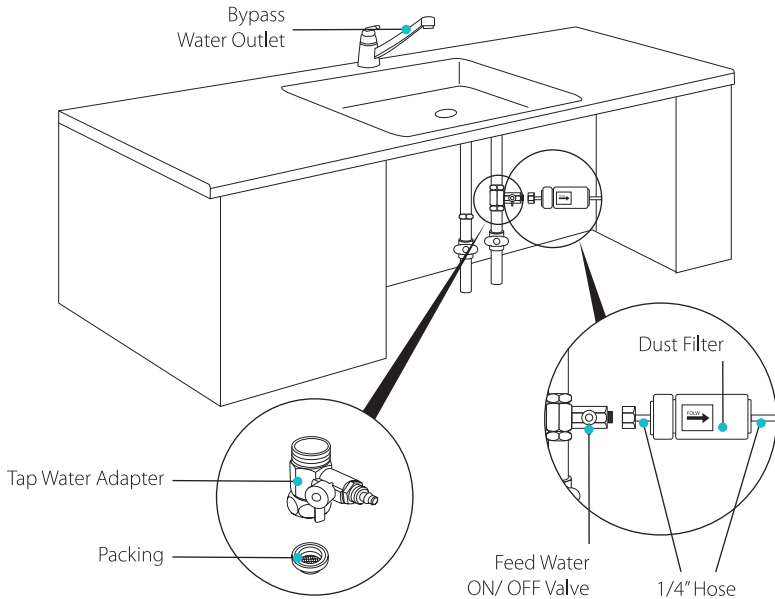

[Figure 1.0]

### Preparing Installation

- 1 Shut off the main water supply (both hot and cold water) by closing the main valve under the sink.
- 2 Look for the cold-water supply line.
- 3 To separate the cold-water supply line from the main cold-water pipe, turn it counter-clockwise using a wrench. Dry the small amount of water that may come from the supply line using a towel.

## Connecting the Adapter

- 4 Connect the tap water adapter to the main cold-water. Tighten with a wrench. Make sure the O-ring is inside the tap water adapter when connecting. This O-ring is crucial to preventing leakage.
- 5 Connect the cold-water supply line to the tap water adapter which is now secured to the main cold-water pipe. Tighten with a wrench.

※ Use Teflon tape (not included) at connections to prevent leakage.

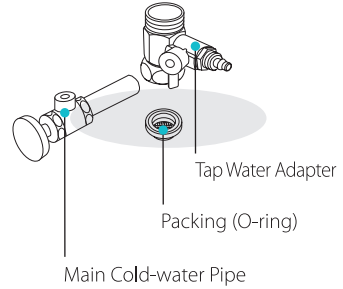

[Figure 1.1]

## Connecting the Dust Filter

- 6 Remove the nut on the side of the tap water adapter. Connect the hose (1/4") to the adapter. Slide the nut through and tighten the nut back onto the adapter.
- 7 Cut the hose (1/4") in the middle. Attach the dust filter to one end of the hose by clicking it in place.

- ※ There is an arrow on the dust filter indicating water flow direction.
- ※ The dust filter will help filter out impurities from the supply water.
- ※ To remove the dust filter, press down onto the protruded part and pull.

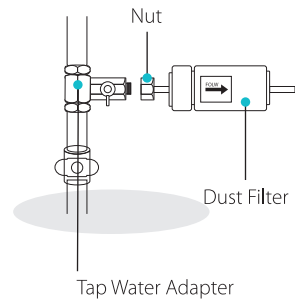

[Figure 1.2]

## Completing Installation

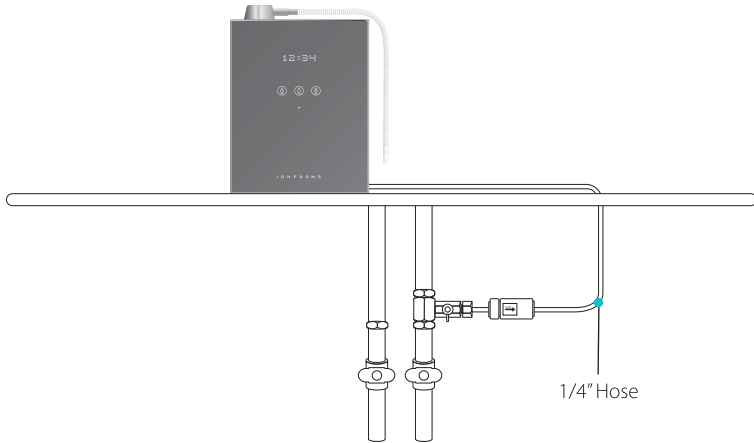

[Figure 1.3]

- 8 Attach the other end of the dust filter to the hose (1/4"). Connect the hose to the water supply inlet (1/4") on the machine. A 6Ø(mm) hole should be drilled on the sink to connect the water source line to the unit.
- 9 Attach the drainage hose to the water outlet on the machine and place it inside the sink.
- 10 Make sure all connections are secure. Open the main valve and turn the power on.

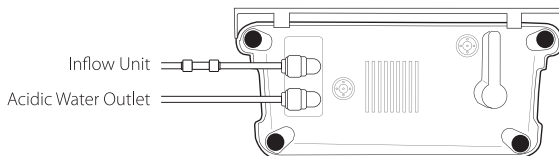

[Figure 1.4]

## 8. Faucet Installation

### Preparing Installation

- 1 Shut off the main water supply (both hot and cold water) by closing the main valve under the sink.
- 2 Remove the existing aerator from the tip of the faucet.

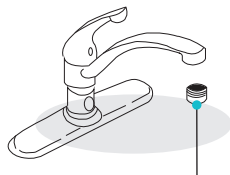

Unscrew the existing aerator from your faucet.

**[Figure 2.1]**

### Connecting the Faucet Diverter

- 3 Connect the faucet diverter to your faucet. Using Teflon tape (not included) helps prevent leakage.
  - ※ If the faucet diverter is not compatible with your faucet, choose an appropriate size adaptor to fit the diverter onto the faucet.
  - ※ Make sure the rubber washer is inside the diverter valve before screwing it onto the faucet. This guarantees a proper seal.
  - ※ Do not run warm water to use the unit. It may cause malfunction.

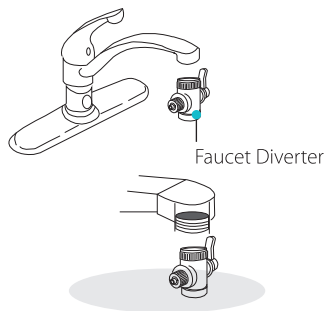

**[Figure 2.2]**

## Connecting the Dust Filter

- 4 Remove the nut on the side of the tap water adapter. Connect the hose (1/4") to the adapter. Slide the nut through and tighten the nut back onto the adapter.
- 5 Cut the hose (1/4") in the middle. Attach the dust filter to one end of the hose by clicking it in place.
  - ※ There is an arrow on the dust filter indicating water flow direction.
  - ※ The dust filter will help filter out impurities from the supply water.
  - ※ To remove the dust filter, press down onto the protruded part and pull.

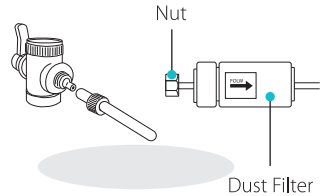

[Figure 2.3]

## Completing Installation

- 6 Attach the other end of the dust filter to the hose (1/4"). Connect the hose to the water supply inlet (1/4") at the machine.
- 7 Connect the drainage hose to the water outlet on the machine and place it inside the sink.
- 8 Make sure all connections are secure. Open the main valve and turn the power on. Make sure to use cold water to operate the unit.

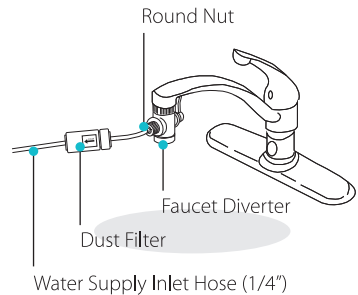

[Figure 2.4]

## 9. Water Hose Installation

- 1 Connect the stem elbows by pressing into the water inflow and outflow holes at the bottom of the unit until there is a click sound and the hose perfectly fits in. (The stem elbows are already installed in the new products.)

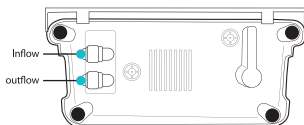

- 2 Make sure to keep the length under 6.5 feet (2 meters) from where the unit will be located on the counter to the faucet or under-sink tap water adaptor where the diverter will be installed. Make sure to cut enough hose (1/4") to allow connection for the rear of the unit to the water supply, either faucet diverter or under-sink tap water adaptor.

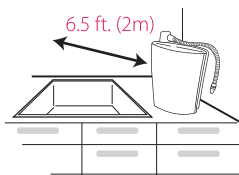

- 3 Connect the hose (1/4") from the inflow hole to the cold water supply, which is either at the faucet diverter or the under-sink tap water adaptor. Connect the dust filter to the hose between the cold water supply and either the faucet diverter or under-sink tap water adaptor.

**Option A:** Pull out the nut from the diverter, slide the nut onto the hose, attach the hose to the faucet diverter, and screw the nut over the hose and back onto the faucet diverter.

**Option B:** Send the hose through the counter-top to the tap water adaptor, attach the hose to the tap water adaptor and make sure it is perfectly connected.

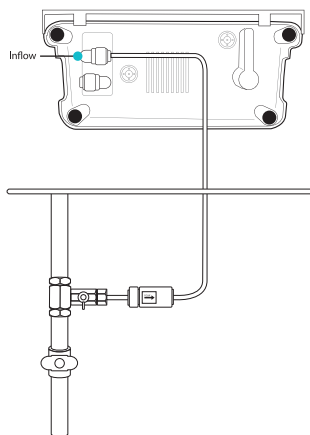

- 4 Cut enough 9mm drainage hose to allow connection for the drain on the rear of the unit to the sink. Make sure the drainage hose is lower than the unit so that it drains properly in the sink.

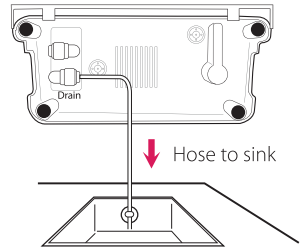

- 5 Make sure all the hose connections are sealed completely in the right holes both on the unit and at the water supply.

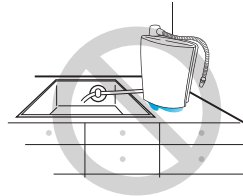

- 6 Turn on the hot/ cold water supply to make sure that there are no leaks at any of the connections or on the bottom of the unit, and that the faucet is working properly for the both water supply. Make sure the hoses are completely seated in the unit holes.

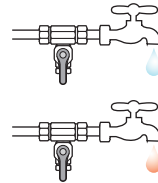

- 7 Plug in the power cord. There should be a series of tones when the unit is powered up.

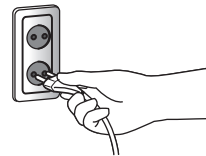

- 8** After the installation, drop 2 or 3 drops of pH reagent into a sample of water, mix and shake well, and compare to the pH scale color chart below:

Acidic Level 2 (Strongly Acidic)	Acidic Level 1 (Medium-Acidic)	CLEAN (Neutral)	Alkaline Level 1 (Mild Alkali)	Alkaline Level 2 (Medium Alkali)	Alkaline Level 3 (Strong Alkali)	Alkaline Level 4 (Strong Alkali)
For cleaning: - fruits - veggies - kitchen - towel - knives	For cleaning: - facial washing	For drinking: - take medication	For drinking	For drinking	For cooking: - cooking water - floriculture - tea brewing	For cleaning: - fruits - veggies - kitchen - towel - knives

If the pH result doesn't match with the color on the pH scale color chart, please refer to the user manual page 35, "LE Mode: Changing pH Level" to begin the pH setting mode and change to the desired pH level based on the pH scale color chart above.



## 10. How to Release Alkaline Water

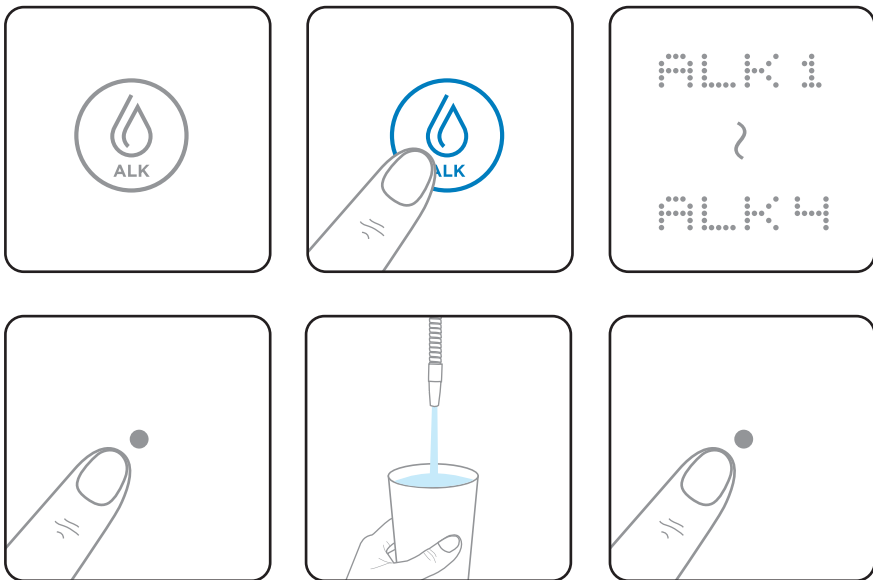

- 1** Touch the “ALK” button to select the desired alkaline water stage.

  - ※ When alkaline water is selected, the color changes from white to blue.
  - ※ There are four stages (1 ~ 4) of alkaline water.
- 2** After selecting the desired stage, touch the ON/OFF button to release alkaline water.

  - ※ When releasing water, the display will provide the following information at 10-second intervals.
    - ① Selected ALK Stage (10 seconds)
    - ② pH Value (10 seconds)
    - ③ Selected ALK Stage (10 seconds)
    - ④ ORP (10 seconds)
- 3** Once the desired amount of water has been released, touch the ON/OFF button again to stop releasing water.

## How to Release Purified Water

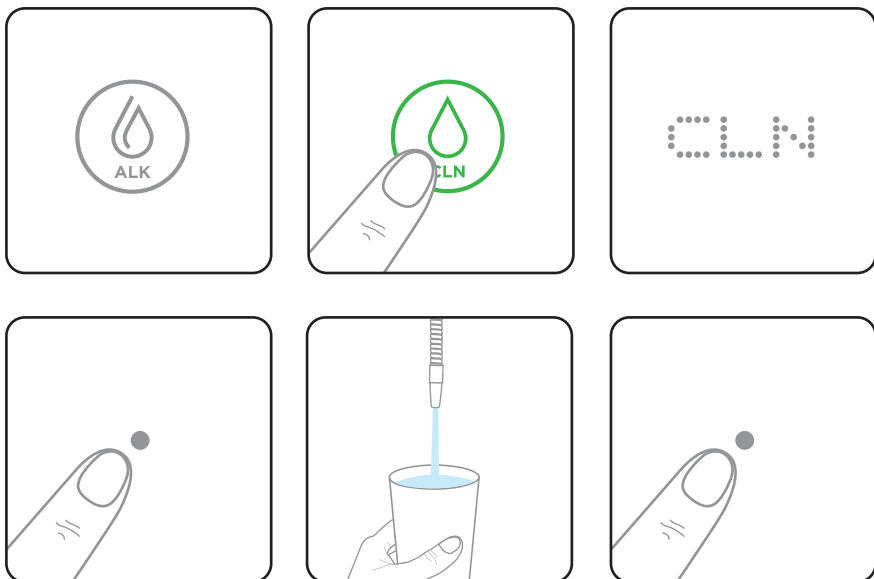

- 1 Touch the “CLN” button to select purified water stage.
  - ※ When purified water is selected, the color changes from white to green.
- 2 Touch the ON/OFF button to release purified water.
  - ※ When releasing water, the display will provide the following information at 10-second intervals:
    - ① Purified Water (10 seconds)
    - ② pH value (10 seconds)
    - ③ Purified Water (10 seconds)
    - ④ ORP (10 seconds)
- 3 Once the desired amount of water has been released, touch the ON/OFF button again to stop releasing water.

## 12. How to Release Acidic Water

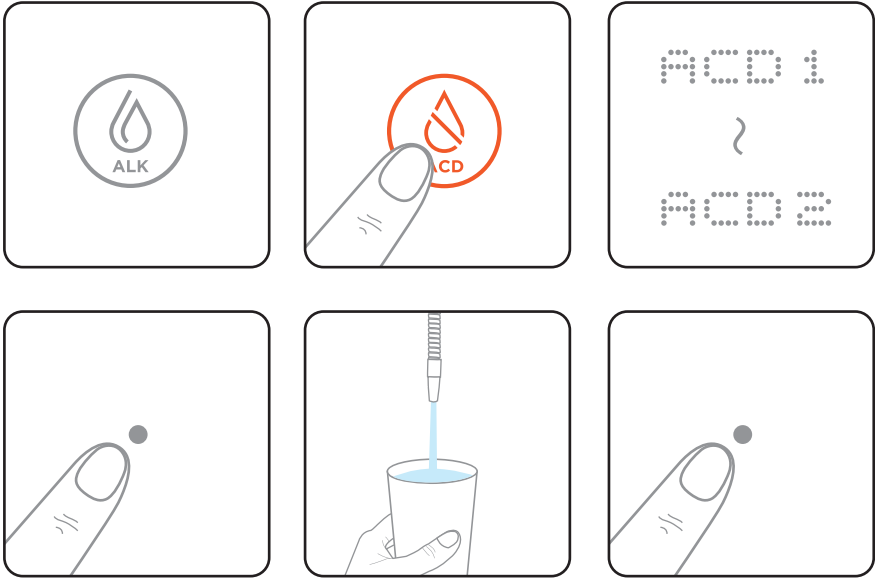

- 1** Touch the “ACD” button to select the desired acidic water stage.

  - ※ When acidic water is selected, the color changes from white to red.
  - ※ There are two stages (1 ~ 2) for acidic water.
- 2** After selecting the desired stage, touch the ON/OFF button to release acidic water.

  - ※ When releasing water, the display will provide the following information at 10-second intervals:
    - ① Selected ACD Stage (10 seconds)
    - ② pH Value (10 seconds)
    - ③ Selected ACD Stage (10 seconds)
    - ④ ORP (10 seconds)
- 3** Once the desired amount of water has been released, touch the ON/OFF button again to stop releasing water.

### 13. Energy Saving Mode (Eco Mode)



- 1 When not in use for 30 mins after an operation (when there is no button touch), it automatically switches to energy saving mode (refer to the picture).
- 2 Touch any button to stop energy saving mode.

## 4. Volume Control

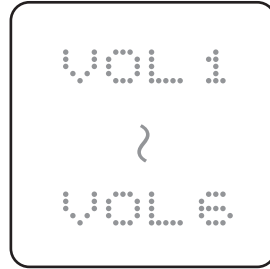
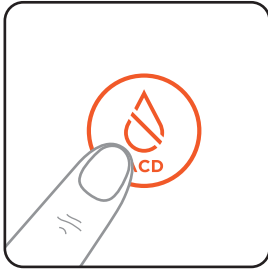

- 1 Touch the "ACD" button for 5 seconds to use volume control mode.
- 2 Lightly touch the "ACD" button again to select the desired volume stage.
  - ※ Volume Setting Stages:
    - Stage 1: Button Sound 1
    - Stage 2: Button Sound 2
    - Stage 3: Button Sound 3
    - Stage 4: Button Sound 1 + Voice 1
    - Stage 5: Button Sound 2 + Voice 2 (Initial Value)
    - Stage 6: Button Sound 3 + Voice 3
- 3 When the volume setting is done, the display automatically changes to the standby mode.

## 15. How to Set Time

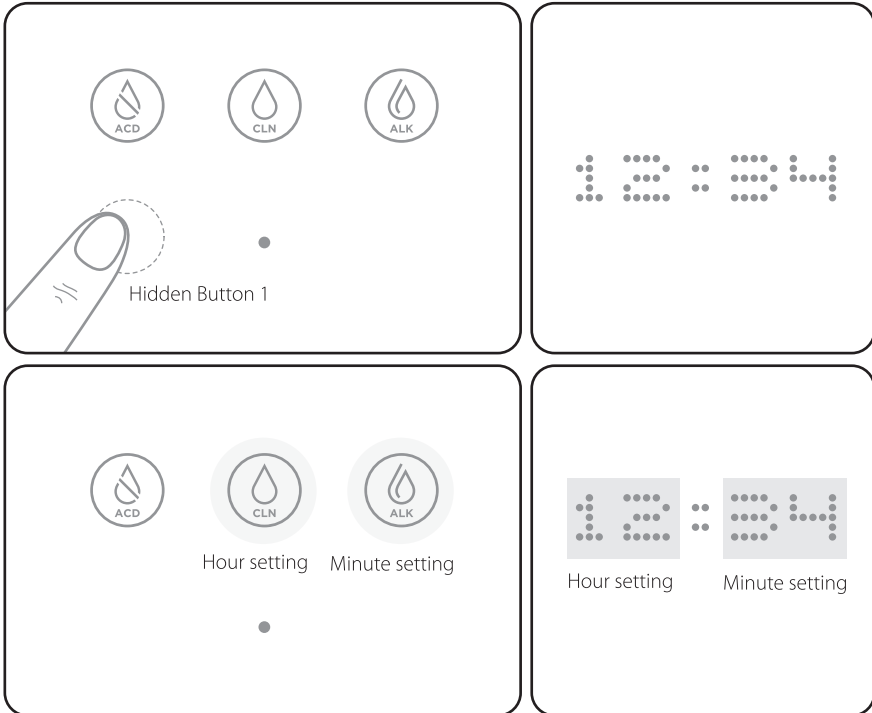

- 1 Touch the "Hidden Button 1" for 3 seconds to enter the time setting mode.  
※ The "Hidden Button 1" is right below the "ACD" button.
- 2 Hour setting = the "CLN" button (00 ~ 23): The digit automatically goes up with continuous touch.  
Minute setting = the "ALK" button (00 ~ 59): The digit automatically goes up with continuous touch.
- 3 Touch the ON/OFF button to finish time setting.

## 16. Checking Remaining Filter Life



- 1 Touch and hold the “Hidden Button 2” located right below the “ALK” button to display the remaining filter life.
  - ※ Must touch twice when in the standby mode (when the display shows time).
  - ※ EX: FLT 100% means the filter is 100% full.  
 FLT 70% means the filter is 70% full. (The value ranges from FLT 100% ~ FLT 0%)
  - ※ The number is adjusted every 24 hours (on average 28L is used per day). The total amount is 5,040L (approximately used for 6 months, 180 days).
- 2 Stop touching the button to return to the standby screen.

## 17. Water Flow Rate Per Minute

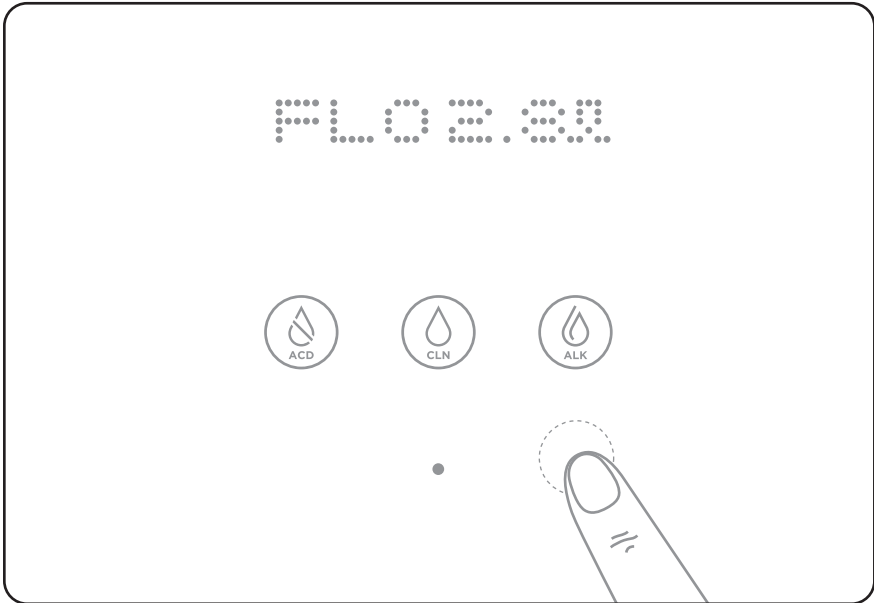

- 1 While the alkaline, acidic, or purified water function is in operation, touch the "Hidden Button 2" to display the rate of water flow per minute.
  - ※ EX: FLO 2.8ℓ = 2.8L of water is purified per minute. (Acidic + Alkaline)
  - ※ When you touch the "Hidden Button 2", the screen will display the rate and then return to stage selection.
- 2 Stop touching the button to return to the standby screen.
- 3 Recommended water flow rate suggestion.
  - ※ Recommended water flow rate: 1.8 ~ 2.5L per minute. (Refer to the user manual page.21)
  - ※ When the water flow rate is higher than the recommended water flow rate: Adjust the water pressure by using the valve at tap water adpater.
  - ※ When the water flow rate is lower than the recommended water flow rate: Adjust the water pressure using pump. (Not included)



## 18. How to Set Button Lock

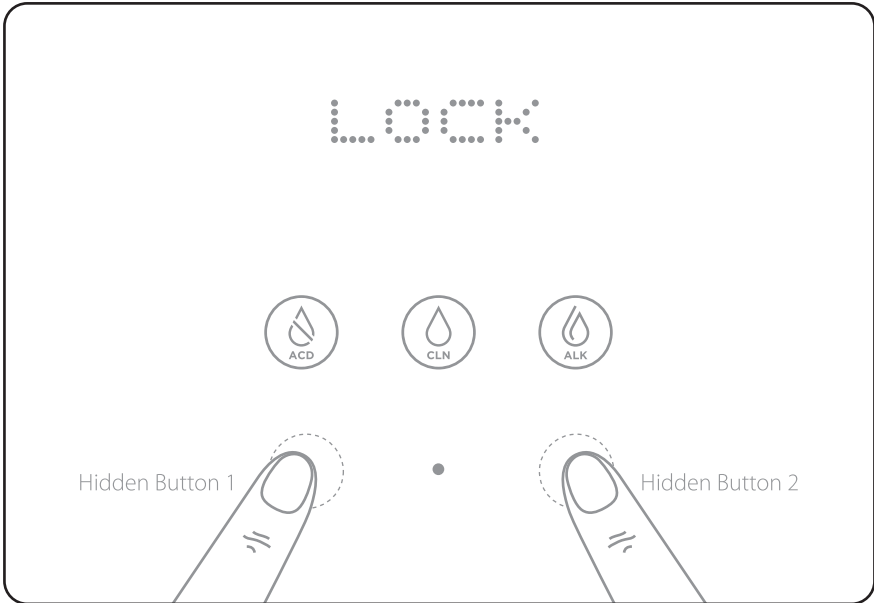

### 1 To Lock the Buttons

Touch the "Hidden Button 1 & 2" simultaneously for 3 seconds to lock the buttons.

※ It will automatically unlock after 5 minutes.

### 2 To Unlock the Buttons

Touch the "Hidden Button 1 & 2" simultaneously for 3 seconds to unlock the buttons.

# 19. Setting Mode Breakdown

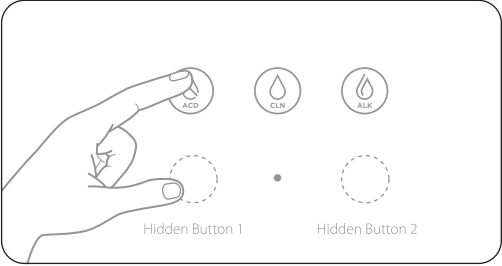
Classification	Menu	Details																								
Setting Mode	Initial Screen When Beginning	 <ul style="list-style-type: none"> <li>▶ <b>To Start</b> Press "ACD" and "Hidden Button 1" simultaneously for 3 seconds while on pause</li> <li>▶ <b>To End</b> Touch "ON/OFF" while in operation</li> <li>▶ <b>Keys to Change Mode</b> <ul style="list-style-type: none"> <li>- Up Key → ACD Button</li> <li>- Down Key → Hidden Button 1</li> </ul> </li> <li>▶ <b>Keys to Change Value</b> <ul style="list-style-type: none"> <li>- Up Key → ALK Button</li> <li>- Down Key → CLN Button</li> </ul> </li> </ul>																								
	LE	<ul style="list-style-type: none"> <li>▶ <b>Raw Water: Possible to Adjust the pH Value</b> <ul style="list-style-type: none"> <li>- Initial Setting: 04</li> <li>- 01 ~ 07 Levels Available to Setting (7 Levels)</li> </ul> </li> </ul>																								
	EC	<ul style="list-style-type: none"> <li>▶ <b>Extra-Cleaning Time Setting: 0 sec ~ 8 sec</b> <ul style="list-style-type: none"> <li>- Initial Setting: 04</li> </ul> <table border="1" style="width: 100%; border-collapse: collapse; text-align: center;"> <thead> <tr> <th>EC</th> <th>Setting</th> <th>EC</th> <th>Setting</th> </tr> </thead> <tbody> <tr> <td>0</td> <td>No extra-cleaning</td> <td></td> <td></td> </tr> <tr> <td>1</td> <td>1 sec cleaning</td> <td>5</td> <td>5 sec cleaning</td> </tr> <tr> <td>2</td> <td>2 sec cleaning</td> <td>6</td> <td>6 sec cleaning</td> </tr> <tr> <td>3</td> <td>3 sec cleaning</td> <td>7</td> <td>7 sec cleaning</td> </tr> <tr> <td>4</td> <td>4 sec cleaning</td> <td>8</td> <td>8 sec cleaning</td> </tr> </tbody> </table> </li> </ul>	EC	Setting	EC	Setting	0	No extra-cleaning			1	1 sec cleaning	5	5 sec cleaning	2	2 sec cleaning	6	6 sec cleaning	3	3 sec cleaning	7	7 sec cleaning	4	4 sec cleaning	8	8 sec cleaning
	EC	Setting	EC	Setting																						
	0	No extra-cleaning																								
1	1 sec cleaning	5	5 sec cleaning																							
2	2 sec cleaning	6	6 sec cleaning																							
3	3 sec cleaning	7	7 sec cleaning																							
4	4 sec cleaning	8	8 sec cleaning																							
F0	<ul style="list-style-type: none"> <li>▶ <b>Display Amount of Filter Used</b> <ul style="list-style-type: none"> <li>- .0 ~ 5,040L</li> </ul> </li> </ul>																									
P0	<ul style="list-style-type: none"> <li>▶ <b>Display Amount of Purified Water Used</b> <ul style="list-style-type: none"> <li>- .0 ~ 5,040L</li> </ul> </li> </ul>																									

Classification	Menu	Details
Setting Mode	A0	▶ Display Amount of Alkaline Water Used - .0 ~ 5,040L
	C0	▶ Display Amount of Acidic Water Used - .0 ~ 5,040L
	T0	▶ Display Total Amount of Water Used - 0 ~ 99,999L Memory (afterwards resets and counts from 0L)
	PN	▶ MAIN PGM Version
	FN	▶ FRONT PGM Version
	LA	▶ Language Selection - 1 ~ 8 Stages
	FA	▶ Filter Change Alarm Setting - 1 ~ 3 Stages
	BL	▶ DOT LED Lighting Setting - Initial Value: 5 (approx. 50%) - Stage Setting: 1 ~ 9

## <How to Operate Setting Mode>

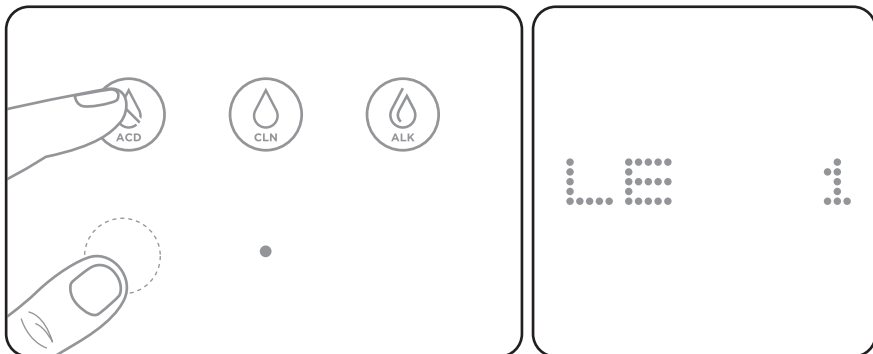

### How to Begin Setting Mode

- ▶ Touch ACD + Hidden Button 1 simultaneously for 3 seconds to begin setting mode.
  - ※ The initial screen for setting mode is "LE"
  - ※ Setting Mode Order  
LE → EC → F0 → P0 → A0 → C0 → T0 → PN → FN → LA → FA → BL

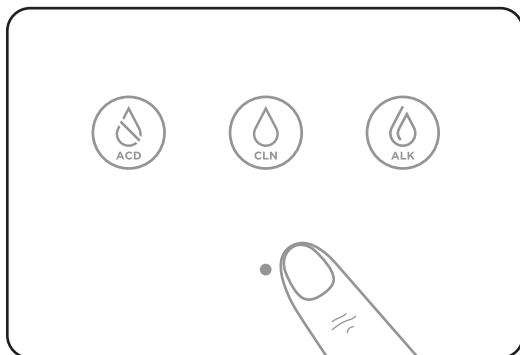

### How to End Setting Mode

- ▶ While in setting mode, touch ON/OFF button to end setting mode.
  - ※ It will return to the most recently used alkaline water stage.

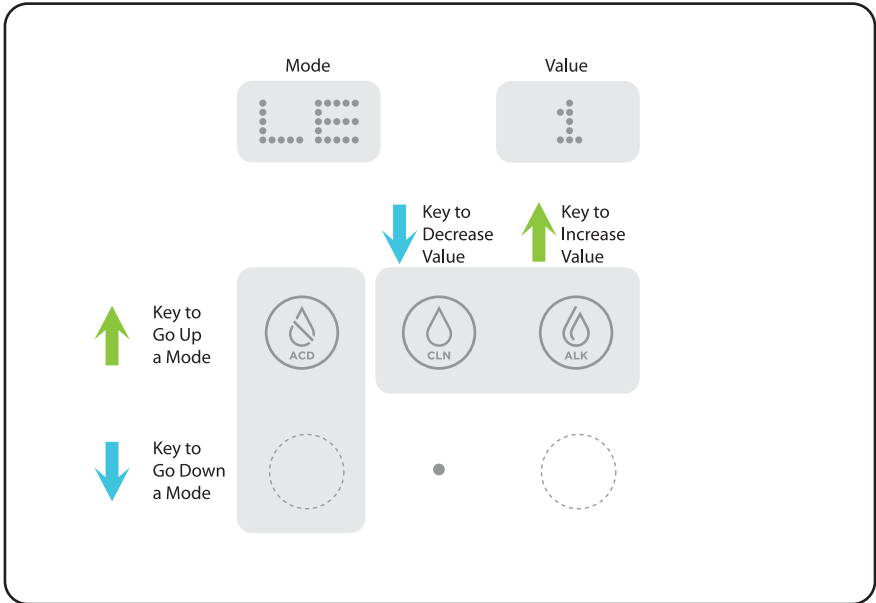

- ▶ **Key to change mode:**
  - Up Key: ACD Button
  - Down Key: Hidden Button 1
- ▶ **Key to change value:**
  - Up Key: ALK Button
  - Down Key: CLN Button

## >> LE Mode: Changing pH Level

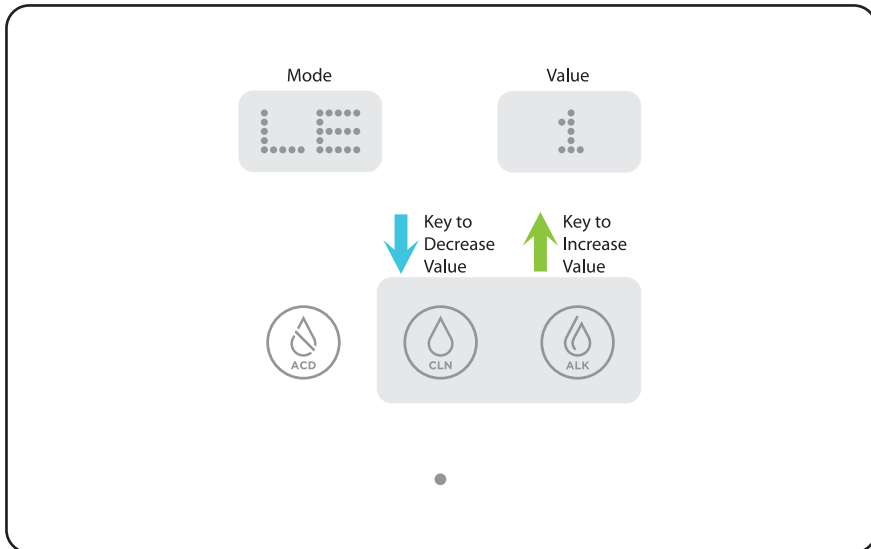

- ▶ **How to enter setting mode:** touch ACD + Hidden button 1 simultaneously for 3 seconds
- ▶ **Please select LE mode by using the buttons below:**
  - Up Key: ACD Button
  - Down Key: Hidden Button 1
- ▶ **Please select LE value by using the buttons below:**
  - Up Key: ALK Button
  - Down Key: CLN Button
- ▶ **How to complete setting change:** touch ON/OFF button.
- ▶ **When setting the pH level, every pH level will be adjusted with the same rate. (Initial Setting: Level 4)**

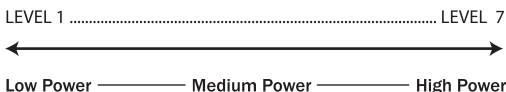
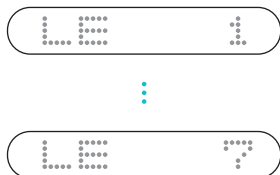

## >> EC: Extra-Cleaning Time Setting

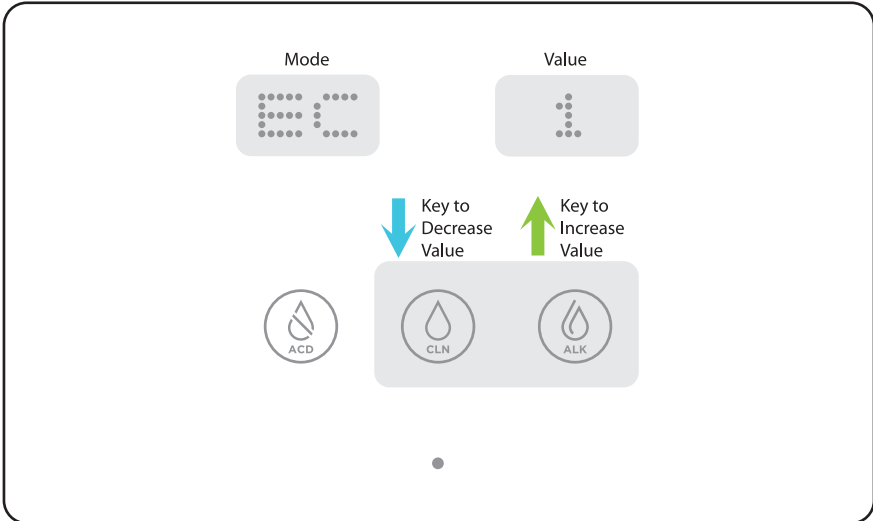

- ▶ **How to enter setting mode:** touch ACD + Hidden button 1 simultaneously for 3 seconds
- ▶ **Please select EC mode by using the buttons below:**  
- Up Key: ACD Button/ - Down Key: Hidden Button 1
- ▶ **Please select EC value by using the buttons below:**  
- Up Key: ALK Button/ - Down Key: CLN Button
- ▶ **How to complete setting change:** touch ON/OFF button.
- ▶ **When cleaning function is set, the solenoid valve is ON and the electrolyzer reverses polarity for the amount of time set.**
- ▶ **When cleaning function is set, the solenoid valve and the electrolyzer shut off automatically after the set amount of time.**



LEVEL 0 ..... LEVEL 8



### What is extra-cleaning?

To remove remaining alkaline minerals inside the product by releasing acidic water 30 seconds after releasing water. For example, "EC4" means acidic water being released for 4 seconds.

- ※ Extra-cleaning starts 30 seconds after a water release. Please turn the water outlet tube towards the sink for extra-cleaning drainage.

## >> F0: Display Amount of Filter Used

- ▶ 0 ~ 5,040L Count Range
- ▶ Displays Up to 5 Digits (0000.0) EX: 1234.5 = 1234.5L Used (the filter currently in use)



[ F0 Mode Display Screen]

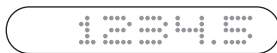

ex) Amount of Filter Used 1,234.5ℓ

## >> P0: Display Amount of Purified Water Used

- ▶ 0 ~ 5,040L Count Range
- ▶ Displays Up to 5 Digits (0000.0) EX: 1234.5 = 1234.5L Used (the filter currently in use)



[ P0 Mode Display Screen]



ex) Amount of Purified Water Used 1,234.5ℓ

## >> A0: Display Amount of Alkaline Water Used

- ▶ 0 ~ 5,040L Count Range
- ▶ Displays Up to 5 Digits (0000.0) EX: 1234.5 = 1234.5L Used (the filter currently in use)



[ A0 Mode Display Screen]



ex) Amount of Alkaline Water Used 1,234.5ℓ



## >> C0: Display Amount of Acidic Water Used

- ▶ 0 ~ 5,040L Count Range
- ▶ Displays Up to 5 Digits (0000.0) EX: 1234.5 = 1234.5L Used (the filter currently in use)



[ C0 Mode Display Screen]

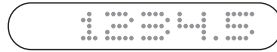

ex) Amount of Acidic Water Used 1,234.5ℓ

## >> T0: Display Total Amount of Water Used (the actual meaning of total amount: the cumulative amount since initial purchase)

- ▶ Displays Up to 6 Digits (00,000.0) EX: 12345.6 = 12,345.6L Used (the product becomes the standard, the value is reset when it is released)



[ T0 Mode Display Screen]



ex) Amount of Water Used 12,345.6ℓ

## >> PN: MAIN PCB PGM Version No. – changes whenever PGM changes

[ PN Confirmation Mode Display Screen]  
EX: MAIN PCB PGM Version =LL03

## >> FN: FRONT PCB PGM Version No. – changes whenever PGM changes

[ FN Confirmation Mode Display Screen]  
EX: FRONT PCB PGM Version =1B03

## >> LA: Language Selection Mode

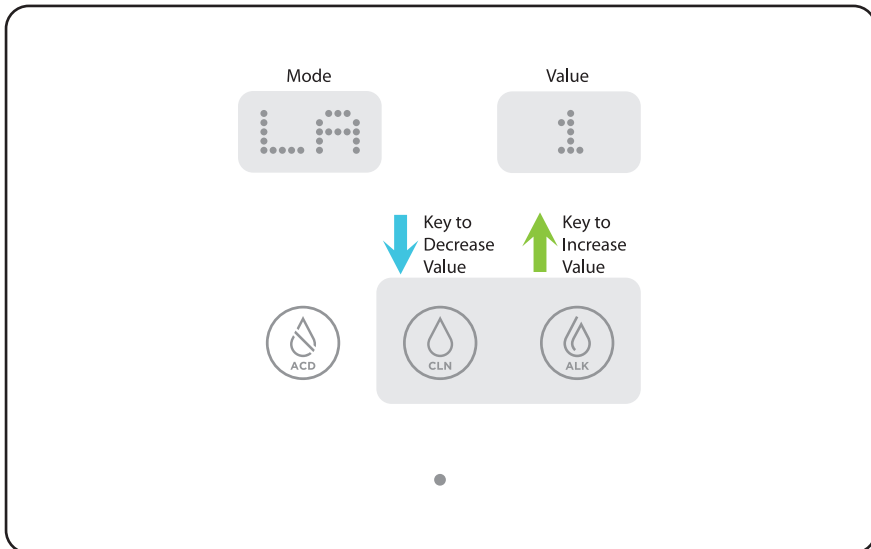

- ▶ **How to enter setting mode:** touch ACD + Hidden button 1 simultaneously for 3 seconds
- ▶ **Please select LA mode by using the buttons below:**
  - Up Key: ACD Button
  - Down Key: Hidden Button 1
- ▶ **Please select LA value by using the buttons below:**
  - Up Key: ALK Button
  - Down Key: CLN Button
- ▶ **How to complete setting change:** touch ON/OFF button.



LA	Language Selected	LA	Language Selected
1	Korean	5	Spanish
2	English	6	Russian
3	Chinese	7	-
4	German	8	-

## >> FA: Filter Change Alarm Setting

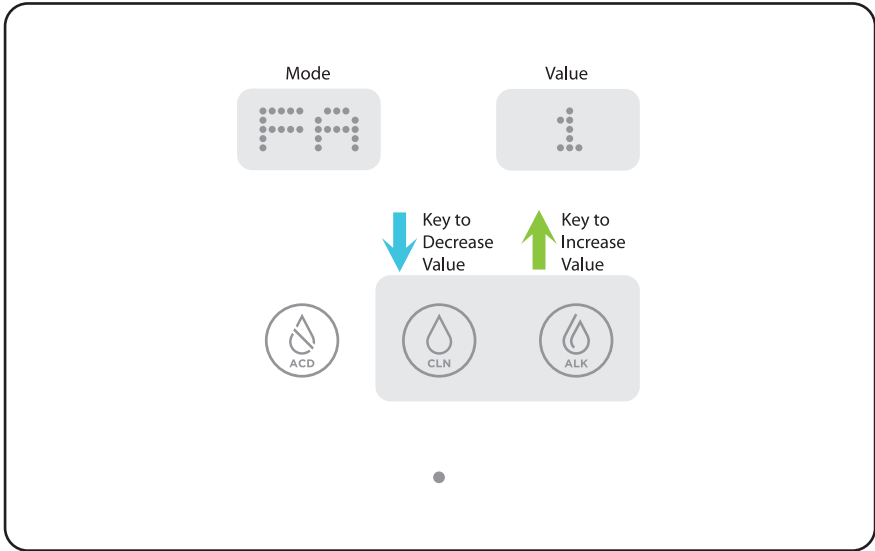

- ▶ **How to enter setting mode:** touch ACD + Hidden button 1 simultaneously for 3 seconds
- ▶ **Please select FA mode by using the buttons below:**
  - Up Key: ACD Button
  - Down Key: Hidden Button 1
- ▶ **Please select FA value by using the buttons below:**
  - Up Key: ALK Button
  - Down Key: CLN Button
- ▶ **How to complete setting change:** touch ON/OFF button.
  - Initial setting: 1

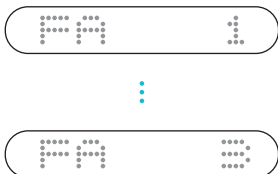

FA	Setting Details
1	Voice Notice Every Operation (Initial Setting)
2	No Voice Notice
3	Voice Notice Every 5 Times START/STOP is Used

## >> BL: DOT LED Lighting Setting

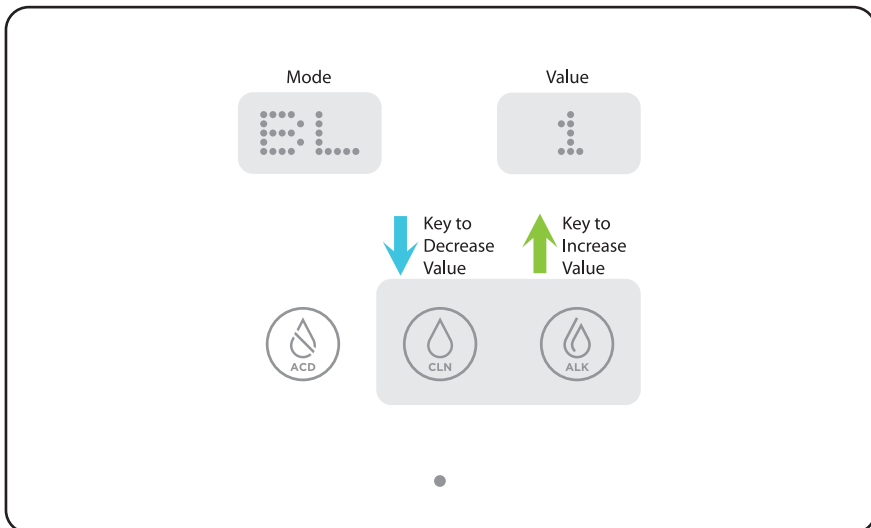

- ▶ **How to enter setting mode:** touch ACD + Hidden button 1 simultaneously for 3 seconds
- ▶ **Please select BL mode by using the buttons below:**
  - Up Key: ACD Button/ - Down Key: Hidden Button 1
- ▶ **Please select BL value by using the buttons below:**
  - Up Key: ALK Button/ - Down Key: CLN Button
- ▶ **How to complete setting change:** touch ON/OFF button.
  - Initial Value: 5
  - Select Stages: 1 ~ 9



Level	Setting Details (Initial Setting: BL 5)
1	DOT LED: Dimmer
2	
3	
4	
5	DOT LED: Medium
6	
7	
8	DOT LED: Brighter
9	

## 20. Measuring pH/ Replacing Fuse

### pH Measurement Method

Drop 3 drops of pH reagent liquid in container and fill it with 10cc of water to be measured. Shake 2 ~ 3 times and the color will change. Compare the color with colorimetric paper and read the color's value to complete measurement.

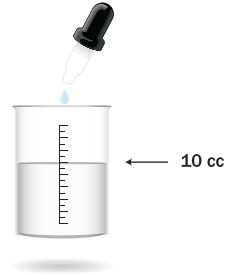

### pH Concentration Color Table

Do not put pH measured water into eye or drink it. Seal pH measured water and store in place away from children's hands. Do not place near fire. It may cause fire.

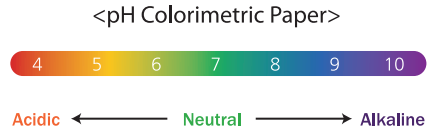

### Fuse Change

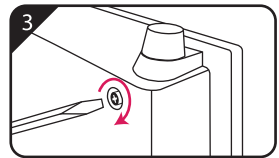
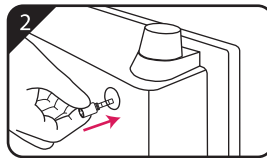
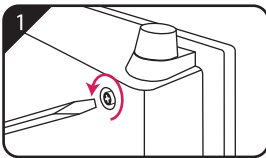

The fuse is located at the upper portion of the back of the unit.

- 1) The fuse can be removed if rotated counter-clockwise with a screwdriver.
- 2) Insert the new fuse (3.15A).
- 3) Tighten the fuse by rotating it clockwise with a screwdriver.

**Note:** When changing the fuse, please make sure to unplug the power cord first. Not doing so may cause electric shock.

## 21. Filter Configuration

### Dual Multi-Layered Filter (Lifespan: 5,000 liters/ 6 months)

- ※ Filter materials may differ depending on regions.  
Please refer to the website for more details.
- ※ To drink clean water, exchange filter regularly according to filter exchange period.
- ※ Exchange filter when the filter exchange icon on display unit flashes.
- ※ Even if filter exchange icon does not operate, exchange if any of the following cases occur.  
- When there is smell or odd taste
- ※ Filter exchange period may differ depending on usage amount, water quality, and water pressure.
- ※ For more details, please refer to the details on the sticker attached to the filter.  
(refer to display matters)

---

### Usage Environment and Condition

- ▶ Do not use source water unsuitable by Waterworks Law standard.
- ▶ Do not use in place with high temperature such as bathroom.
- ▶ Do not use in place with high humidity or temperature.
- ▶ Do not use in chemical drug storage or area generating gas.
- ▶ Do not use in place affected by air pressure, wind, sunlight, salt, etc.
- ▶ Please use in stable location without slope.
- ▶ Do not use in place with low water pressure (below 14.2psi) and source water quantity (under 1ℓ/min).
- ▶ Usage condition
  - ※ Temperature:  $\pm 5^{\circ}\text{C} \sim +50^{\circ}\text{C}$
  - ※ Moisture:  $\pm 70\%$
  - ※ Air pressure: 1013hpa  $\sim$  877hpa

## 22. Replacing Filter

Please use the genuine filters only. The seller and the manufacturer are not responsible when inauthentic filters are used. (How to check authenticity: Check if the hologram sticker inside the filter cover and the sticker on the filter replacement box are the same.)

- 1**

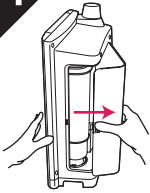

Open the filter cover.
- 2**

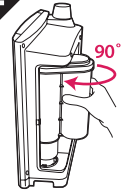

Hold the right part of the filter and turn it 90 degrees to the left.
- 3**

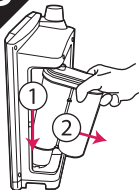

Lightly press the top of the filter and pull it to detach.
- 4**

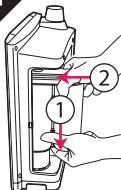

Insert the new filter to bottom. Lightly press and push the filter to click into the top.
- 5**

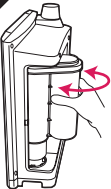

Move the filter to the left and right to place it in position.
- 6**

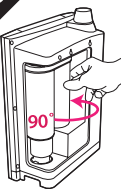

Turn the filter 90 degrees to the right.
- 7**



Connect to power and operate the device in CLN mode for 3 to 5 minutes to check for leaks.
- 8**

CLN

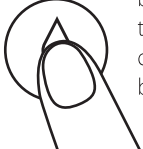

Keep pressing CLN button for 10 seconds to reset the filter. It's completed with a beep sound.

## 23. Filter Reset

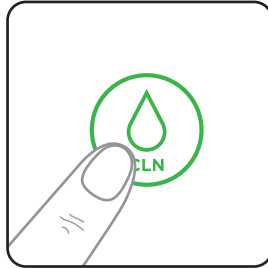

- ▶ Touch the “CLN” button for 10 seconds to reset the filter.
  - ※ When the reset is complete, it'll make a beep sound with a voice notice “filter reset is complete.”



## 24. Forced Operation Function

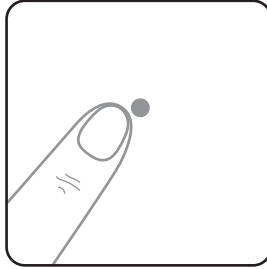

- ▶ When the product is not working due to a water flow sensor defect, this function can be used.
  - ※ Forced operation: Touch the ON/OFF button for 5 seconds to forcibly operate the selected stage (there will be a beep sound). Release the button when it works.
  - ※ Forced pause: Touch the ON/OFF button briefly to pause the operation (Same as normal operation).
  - ※ It is possible to change to acidic/alkaline/purified water during an operation.
  - ※ This forced operation can be used even when there is no water flow sensor defect.

## 25. Troubleshooting

If there is ANY TROUBLE IN OPERATING this device, please read the instructions carefully and use the checklist below. Please call your local representative if there is still a problem.

Symptoms	Things to check for	Possible solutions
No power to the unit or the ON/ OFF button does not illuminate.	Are the power cord and plug properly connected?	Plug in properly and switch on the power to the unit.
	When you are satisfied that the unit is receiving power but the ON/ OFF button does not illuminate, check the internal fuse.	If the fuse has blown, then replace the fuse. Please see "how to change the fuse."
There is power to the unit, the ON/ OFF button illuminates but there is sporadic or no water generation.	Is the water supply cutoff valve open?	Open the water supply cutoff valve.
	Check ALL water supply connections.	Connect all pipes properly
	Water supply hose bent or folded?	Ensure that the water hose is free from constrictions.
	Low water pressure? (Below 0.7 kg/ cm <sup>2</sup> )	The unit cannot be used in areas of low water pressure. Contact your local representative.
	No feed water supply or frozen?	Wait until water supply resumes
	Filter blocked?	Replace filter.
NO alkalinity?	Check if any figure appears on the screen.	See how to adjust machine according to feed water quality.
Low alkalinity?	Do you reside in an area of high water hardness?	Alkalinity will be different depending on water hardness area and feed water quality.
	Over supply of water?	Reduce the amount of feed water supply flow. (Normal: 2~3bar of 5)
	Not enough drainage?	Contact your local representative.
Stops in the middle of operation.	Has continuous operation time passed 10 minutes?	The unit automatically stops after 10 minutes of continuous operation. Please wait for the on button on the screen to illuminate. The unit will then be ready to use.
Leakage from filter	Is it installed properly?	Replace the filter. If the problem persists then contact your local distributor. Some leakage possibly in filter. Stop operation and ask for help from Local Rep.
	Any leakage in the main body?	
There are strang odor or the water tastes different.	Unused for a long time?	Flush water for more than 3~5 minutes. If the problem persists, replace the filter.
	Excess alkalinity?	Increase the water supply by opening the supply valve.
	Filter change overdue?	Replace filter.
Water does not look clean.	Is something white deposited at the base of the container?	Calcium or other minerals can be present depending on area. No problem to drink water.

## 26. Specifications

<b>Manufacturer</b>	IonFarms Co.,Ltd
<b>Product Name</b>	Alkaline Water Ionizer
<b>Model</b>	Alpha-1500/ 1700 Series
<b>Rated Voltage</b>	AC100~120V; 50~60Hz/ AC220~240V; 50~60Hz
<b>Electric Consumption</b>	Max. 160W
<b>Power Protector</b>	Fuse 3.15A
<b>Weight</b>	14.33 lb (6.5 kg)
<b>Packaging Unit</b>	1 EA
<b>Required Water Pressure</b>	98 kPa ~ 686 kPa
<b>Instructions</b>	Refer to User Manual
<b>Water Volume Generated</b>	2 ~3 liters/ min (0.53 gallon ~ 0.79 gallon/min)
<b>Cleaning</b>	Automatic Cleaning System
<b>Filter Lifespan</b>	5,000 liters/ 6 months (may vary by water quality - Hardness)

- ※ The information in this manual is subject to change without notice for performance improvement. Please check our website for the latest version.
- ※ Home use only.

## 27. Product Warranty

# Product Warranty

★ Alkaline Water Ionizer ★

- **Product Name:** Alkaline Water Ionizer \_\_\_\_\_
- **Manufacturer's Serial Number:** \_\_\_\_\_
- **Model Name:** \_\_\_\_\_
- **Purchase Date:** \_\_\_\_\_
- **Seller:** (Name) (Phone Number) (Address) \_\_\_\_\_
- **Buyer:** (Name) (Phone Number) (Address) \_\_\_\_\_

This alkaline water ionizer is manufactured under strict quality control and inspections. When the product is defective while being used correctly, the repair will be done for free of charge based on this product warranty. This product is warranted for 3 years (36months).

- When requesting a repair, please submit the warranty to the purchased store or to the after-sales service center.
- In the case the warranty is not submitted, please talk to one of the staff members at the purchased store.
- This warranty won't be reissued, so please keep this well.
- After the warranty period expires, repairs costs will be charged against failures.

#### Warranty regulations.

1. When the product is defective while being used correctly, repair will be done for free of charge within the warranty period.
2. The warranty period is three years after purchase, and accessories are excluded.
3. Repair fee will be charged even within the warranty period for the following cases:
  - 1) Malfunctions or defects by customers' misuse, arbitrary disassemble, configuration or fix.
  - 2) Malfunctions or defects by changing the initial installation place, or falling
  - 3) Malfunctions or defects by natural disasters such as fire, salt damage, gas damage, abnormal voltage, earthquake, thunderstroke, and wind and flood damage.
  - 4) Omission of the purchased year, month, day or store on the warranty or arbitrary amendment of this warranty.
  - 5) No submission of the warranty.
  - 6) Repairs or modifications done by non-authorized representatives.
  - 7) Usage other than domestic use.



<http://www.ionfarms.com>

