

# **L3250/L3251 User's Guide**



---

# Contents

|  |           |
|--|-----------|
| <b>L3250/L3251 User's Guide</b> .....                            | <b>11</b> |
| <b>Product Basics</b> .....                                      | <b>12</b> |
| Control Panel Buttons and Lights .....                           | 12        |
| Product Parts Locations .....                                    | 13        |
| Product Parts - Front .....                                      | 13        |
| Product Parts - Inside .....                                     | 14        |
| Product Parts - Back.....  | 16        |
| The Power Off and Sleep Timers .....                             | 16        |
| Changing the Power Off and Sleep Timer Settings - Windows .....  | 16        |
| Changing the Power Off and Sleep Timer Settings - Mac.....       | 17        |
| Using the Epson Smart Panel Mobile App.....                      | 18        |
| Epson Connect Solutions for Smartphones, Tablets, and More ..... | 19        |
| Using Epson Email Print .....                                    | 20        |
| Using Epson Remote Print .....                                   | 20        |
| Setting Up Printing on a Chromebook .....                        | 21        |
| Android Printing Using the Epson Print Enabler .....             | 21        |
| Using Fire OS Printing .....                                     | 21        |
| Using Windows 10 Mobile Printing .....                           | 22        |
| Using Epson Print and Scan App with Windows Tablets .....        | 22        |
| <b>Wi-Fi Networking</b> .....                                    | <b>24</b> |
| Network Security Recommendations .....                           | 24        |
| Wi-Fi Direct Mode Setup .....                                    | 25        |
| Enabling Wi-Fi Direct Mode .....                                 | 25        |
| Wi-Fi Protected Setup (WPS).....                                 | 26        |
| Using WPS to Connect to a Network .....                          | 26        |
| Printing a Network Status Sheet.....                             | 27        |
| Printing a Network Connection Report .....                       | 27        |
| Network Connection Report Codes and Messages .....               | 28        |
| Changing or Updating Network Connections .....                   | 33        |
| Accessing the Web Config Utility .....                           | 33        |

|   |           |
|---|-----------|
| Changing a USB Connection to a Wi-Fi Connection.....          | 34        |
| Connecting to a New Wi-Fi Router .....                        | 34        |
| Disabling Wi-Fi Features .....                                | 35        |
| <b>Loading Paper .....</b>                                    | <b>36</b> |
| Loading Paper in the Sheet Feeder.....                        | 36        |
| Paper Loading Capacity .....                                  | 40        |
| Double-sided Printing Capacity .....                          | 40        |
| Compatible Epson Papers.....                                  | 41        |
| Borderless Paper Type Compatibility .....                     | 43        |
| Paper or Media Type Settings .....                            | 44        |
| <b>Placing Originals on the Product .....</b>                 | <b>45</b> |
| Placing Originals on the Scanner Glass .....                  | 45        |
| <b>Copying.....</b>   | <b>47</b> |
| Changing the Default Paper Size using the Control Panel ..... | 47        |
| Copying Documents or Photos.....                              | 47        |
| <b>Printing from a Computer .....</b>                         | <b>49</b> |
| Printing with Windows .....                                   | 49        |
| Selecting Basic Print Settings - Windows .....                | 50        |
| Print Quality Options - Windows .....                         | 52        |
| Multi-Page Printing Options - Windows.....                    | 52        |
| Selecting Double-sided Printing Settings - Windows .....      | 53        |
| Double-sided Printing Options - Windows.....                  | 55        |
| Selecting Additional Layout and Print Options - Windows ..... | 56        |
| Custom Color Correction Options - Windows.....                | 58        |
| Image Options and Additional Settings - Windows.....          | 59        |
| Header/Footer Settings - Windows .....                        | 60        |
| Selecting a Printing Preset - Windows.....                    | 61        |
| Selecting Extended Settings - Windows .....                   | 63        |
| Extended Settings - Windows .....                             | 64        |
| Printing Your Document or Photo - Windows.....                | 65        |
| Checking Print Status - Windows .....                         | 67        |
| Locking Printer Settings - Windows .....                      | 67        |

|   |           |
|---|-----------|
| Locked Setting Options .....                                | 69        |
| Selecting Default Print Settings - Windows.....             | 70        |
| Changing the Language of the Printer Software Screens ..... | 71        |
| Changing Automatic Update Options .....                     | 72        |
| Printing with the Built-in Epson Driver - Windows 10 S..... | 73        |
| Selecting Print Settings - Windows 10 S.....                | 74        |
| Printing on a Mac .....                                     | 76        |
| Selecting Basic Print Settings - Mac .....                  | 77        |
| Print Quality Options - Mac .....                           | 80        |
| Print Options - Mac .....                                   | 81        |
| Selecting Page Setup Settings - Mac .....                   | 81        |
| Selecting Print Layout Options - Mac.....                   | 82        |
| Managing Color - Mac .....                                  | 83        |
| Color Matching and Color Options - Mac .....                | 84        |
| Selecting Printing Preferences - Mac .....                  | 85        |
| Printing Preferences - Mac.....                             | 85        |
| Printing Your Document or Photo - Mac .....                 | 86        |
| Checking Print Status - Mac.....                            | 87        |
| Printing from a Smartphone or Tablet.....                   | 88        |
| Printing with Epson Photo+ .....                            | 89        |
| Cancelling Printing Using a Product Button.....             | 89        |
| <b>Scanning .....</b>                                       | <b>90</b> |
| Starting a Scan.....  | 90        |
| Starting a Scan Using the Product Buttons.....              | 90        |
| Changing Default Scan Job Settings .....                    | 91        |
| Setting Up a WSD Port (Windows 7/Windows Vista) .....       | 91        |
| Starting a Scan Using Epson ScanSmart .....                 | 92        |
| Starting a Scan Using the Epson Scan 2 Icon .....           | 93        |
| Starting a Scan from a Scanning Program.....                | 95        |
| Starting a Scan from a Smartphone or Tablet.....            | 97        |
| Scanning a Document or Photo in Epson ScanSmart .....       | 97        |
| Saving a Scan .....   | 100       |
| Attaching a Scan to Email.....                              | 101       |

|   |            |
|---|------------|
| Sending a Scan to a Cloud Service .....                               | 102        |
| Printing a Scan .....   | 103        |
| Selecting Epson ScanSmart Settings.....                               | 105        |
| Changing the Epson Product.....                                       | 105        |
| Changing the Scan Settings .....                                      | 106        |
| Changing the File Name Settings .....                                 | 108        |
| Changing the Save Settings .....                                      | 109        |
| Save Settings .....   | 111        |
| Customizing Action Icons .....  | 112        |
| Scanning in Epson Scan 2 .....  | 114        |
| Additional Scanning Settings - Main Settings Tab .....                | 117        |
| Additional Scanning Settings - Advanced Settings Tab .....            | 118        |
| Saving Scanned Documents as a Searchable PDF Using Epson Scan 2 ..... | 119        |
| Image Format Options .....  | 120        |
| Scan Resolution Guidelines .....                                      | 121        |
| <b>Refilling Ink .....</b>  | <b>123</b> |
| Ink Safety Precautions .....  | 123        |
| Checking Ink Levels on Your Product.....                              | 125        |
| Disabling Special Offers with Windows .....                           | 125        |
| Purchase Epson Ink .....  | 126        |
| Ink Bottle Part Numbers.....  | 127        |
| Refilling the Ink Tanks .....   | 127        |
| <b>Adjusting Print Quality.....</b>                                   | <b>133</b> |
| Print Head Maintenance.....   | 133        |
| Print Head Nozzle Check.....  | 133        |
| Checking the Nozzles Using the Product Buttons .....                  | 134        |
| Checking the Nozzles Using a Computer Utility .....                   | 136        |
| Print Head Cleaning .....   | 139        |
| Cleaning the Print Head Using the Product Buttons.....                | 139        |
| Cleaning the Print Head Using a Computer Utility.....                 | 141        |
| Power Cleaning .....  | 144        |
| Power Cleaning Using a Computer Utility .....                         | 144        |
| Print Head Alignment .....  | 146        |

|   |            |
|---|------------|
| Aligning the Print Head Using a Computer Utility .....            | 146        |
| Cleaning the Paper Path .....                                     | 148        |
| Checking the Number of Sheets Fed.....                            | 149        |
| Checking the Sheet Counter - Windows .....                        | 149        |
| Checking the Sheet Counter - Mac.....                             | 150        |
| <b>Cleaning and Transporting Your Product .....</b>               | <b>152</b> |
| Cleaning Your Product .....                                       | 152        |
| Transporting Your Product .....                                   | 152        |
| <b>Solving Problems .....</b>                                     | <b>157</b> |
| Checking for Software Updates.....                                | 157        |
| Product Light Status .....  | 158        |
| Running a Product Check .....                                     | 160        |
| Resetting Network Settings .....                                  | 162        |
| Solving Setup Problems .....                                      | 162        |
| Product Does Not Turn On or Off.....                              | 162        |
| Noise After Filling the Ink.....                                  | 163        |
| Software Installation Problems .....                              | 163        |
| Solving Network Problems .....                                    | 164        |
| Product Cannot Connect to a Wireless Router or Access Point ..... | 164        |
| Network Software Cannot Find Product on a Network.....            | 166        |
| Product Does Not Appear in Mac Printer Window .....               | 167        |
| Wireless Network Connection is Unstable on a Mac .....            | 168        |
| Cannot Print Over a Network.....                                  | 168        |
| Cannot Scan Over a Network .....                                  | 169        |
| Solving Copying Problems .....                                    | 170        |
| Product Makes Noise, But Nothing Copies.....                      | 170        |
| Product Makes Noise When It Sits for a While.....                 | 171        |
| Copies are Cut Off .....  | 171        |
| Copies Have Incorrect or Faint Colors.....                        | 171        |
| Position, Size, or Margins of Copies are Incorrect.....           | 172        |
| Solving Paper Problems .....                                      | 172        |
| Paper Feeding Problems.....                                       | 172        |
| Paper Jam Problems .....  | 173        |

|   |     |
|---|-----|
| Paper Ejection Problems .....   | 177 |
| Solving Problems Printing from a Computer.....                              | 177 |
| Nothing Prints .....  | 177 |
| Product Icon Does Not Appear in Windows Taskbar .....                       | 178 |
| Printing is Slow .....  | 179 |
| Solving Page Layout and Content Problems .....                              | 181 |
| Inverted Image.....   | 181 |
| Too Many Copies Print .....   | 182 |
| Blank Pages Print .....   | 182 |
| Incorrect Margins on Printout.....  | 182 |
| Border Appears on Borderless Prints .....                                   | 183 |
| Incorrect Characters Print.....   | 184 |
| Incorrect Image Size or Position .....                                      | 184 |
| Slanted Printout .....  | 185 |
| Solving Print Quality Problems .....  | 186 |
| White or Dark Lines in Printout .....                                       | 186 |
| Blurry or Smearred Printout .....   | 187 |
| Faint Printout or Printout Has Gaps .....                                   | 189 |
| Grainy Printout.....  | 190 |
| Incorrect Colors .....  | 191 |
| Solving Scanning Problems .....   | 192 |
| Scanning Software Does Not Operate Correctly .....                          | 192 |
| Cannot Start Epson Scan 2 .....   | 193 |
| Scanning is Slow .....  | 194 |
| Solving Scanned Image Quality Problems .....                                | 194 |
| Image Consists of a Few Dots Only.....                                      | 194 |
| Line of Dots Appears in All Scanned Images.....                             | 195 |
| Straight Lines in an Image Appear Crooked .....                             | 195 |
| Scanned Image Quality Problems .....  | 196 |
| Characters are Not Recognized During Conversion to Editable Text (OCR)..... | 197 |
| Image Colors are Patchy at the Edges .....                                  | 197 |
| Ripple Patterns Appear in an Image .....                                    | 198 |
| Scanned Image Edges are Cropped .....                                       | 198 |



|   |            |
|---|------------|
| Resetting the Epson Scan 2 Settings .....                         | 198        |
| Uninstall Your Product Software.....                              | 199        |
| Uninstalling Product Software - Windows .....                     | 199        |
| Uninstalling Product Software - Mac.....                          | 200        |
| Where to Get Help.....  | 201        |
| <b>Technical Specifications .....</b>                             | <b>203</b> |
| Windows System Requirements .....                                 | 203        |
| Mac System Requirements .....                                     | 204        |
| Paper Specifications .....  | 204        |
| Printable Area Specifications .....                               | 206        |
| Scanning Specifications .....                                     | 208        |
| Ink Specifications .....  | 208        |
| Dimension Specifications .....                                    | 209        |
| Electrical Specifications .....                                   | 209        |
| Environmental Specifications .....                                | 210        |
| Interface Specifications .....                                    | 210        |
| Network Interface Specifications .....                            | 211        |
| <b>Notices .....</b>  | <b>212</b> |
| Important Safety Instructions.....                                | 212        |
| General Printer Safety Instructions.....                          | 212        |
| Wireless Connection Safety Instructions .....                     | 214        |
| FCC Compliance Statement.....                                     | 214        |
| Binding Arbitration and Class Waiver .....                        | 215        |
| Trademarks .....  | 218        |
| Copyright Notice.....   | 218        |
| libTIFF Software Acknowledgment.....                              | 219        |
| A Note Concerning Responsible Use of Copyrighted Materials.....   | 220        |
| Default Delay Times for Power Management for Epson Products ..... | 220        |
| Copyright Attribution .....                                       | 220        |



---

## L3250/L3251 User's Guide

Welcome to the L3250/L3251 *User's Guide*.

For a printable PDF copy of this guide, [click here](#).

**Note:** Availability of products in this guide varies by country.

---

# Product Basics

See these sections to learn about the basic features of your product.

[Control Panel Buttons and Lights](#)

[Product Parts Locations](#)

[The Power Off and Sleep Timers](#)

[Using the Epson Smart Panel Mobile App](#)

[Epson Connect Solutions for Smartphones, Tablets, and More](#)

[Setting Up Printing on a Chromebook](#)

[Android Printing Using the Epson Print Enabler](#)

[Using Fire OS Printing](#)



[Using Windows 10 Mobile Printing](#)

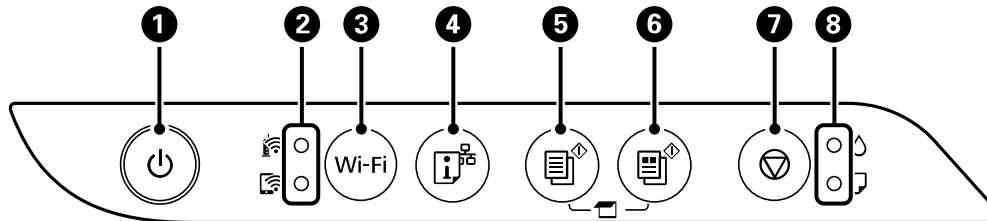

[Using Epson Print and Scan App with Windows Tablets](#)

## Control Panel Buttons and Lights



- 1 power button and light
- 2 Wi-Fi and Wi-Fi Direct network status lights
- 3 **Wi-Fi** button
- 4 network status button
- 5 B&W copy button
- 6 color copy button
- 7 stop button

8  ink and  paper lights

| Light status   | Condition/solution                                       |
|--|--|
|  power light is on        | The product is turned on.                                |
|  Wi-Fi light is on        | The product is connected to a wireless network.          |
|  Wi-Fi Direct light is on | The product is connected to a device using Wi-Fi Direct. |

Parent topic: [Product Basics](#)

## Product Parts Locations

See these sections to identify the parts on your product.

[Product Parts - Front](#)

[Product Parts - Inside](#)

[Product Parts - Back](#)

Parent topic: [Product Basics](#)

### Product Parts - Front

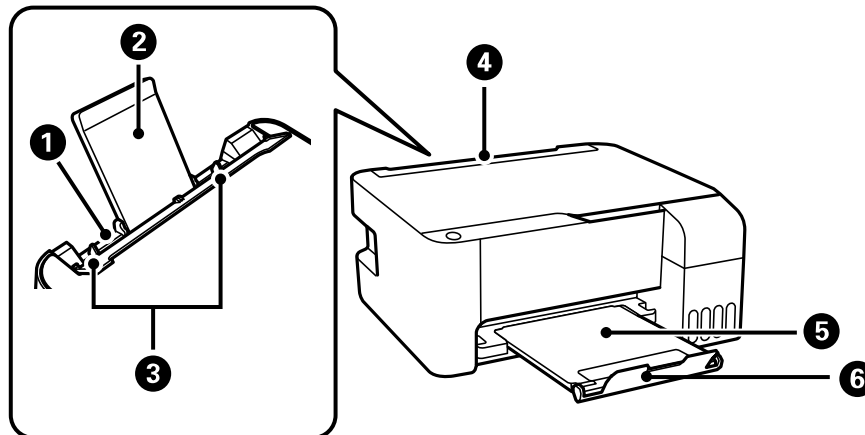

1 Rear paper feeder

- 2 Paper support
- 3 Edge guides
- 4 Feeder guard
- 5 Output tray
- 6 Paper stopper

Parent topic: [Product Parts Locations](#)

### Product Parts - Inside

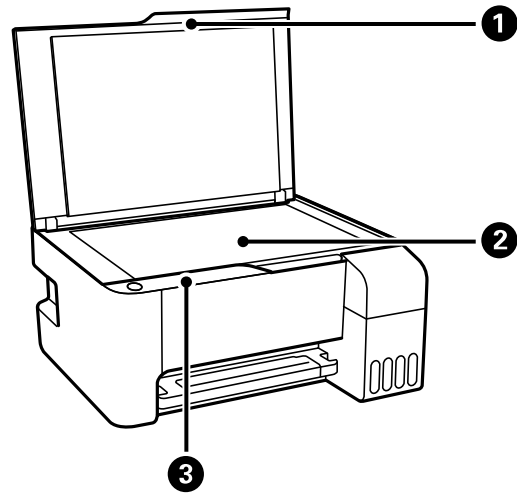

- 1 Document cover
- 2 Scanner glass

### 3 Control panel

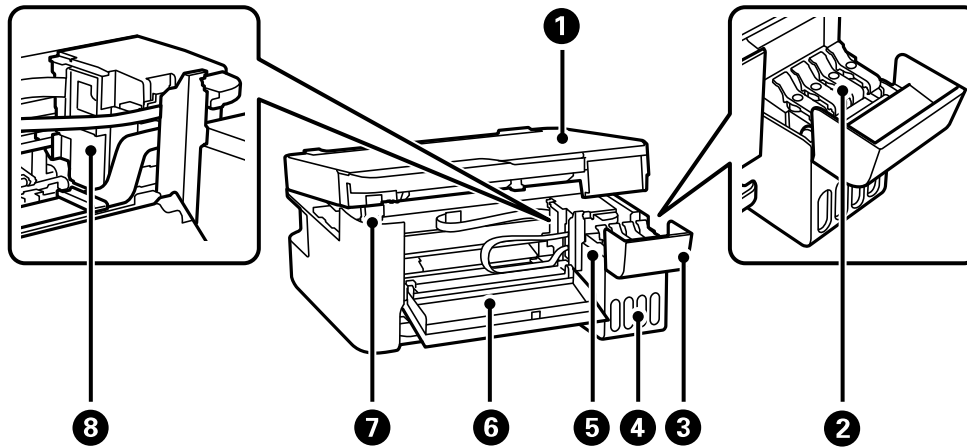

- 1 Scanner unit
- 2 Ink tank cap
- 3 Ink tank cover
- 4 Ink tank unit
- 5 Ink tanks
- 6 Front cover
- 7 Scanner unit support
- 8 Print head

**Parent topic:** [Product Parts Locations](#)

## Product Parts - Back

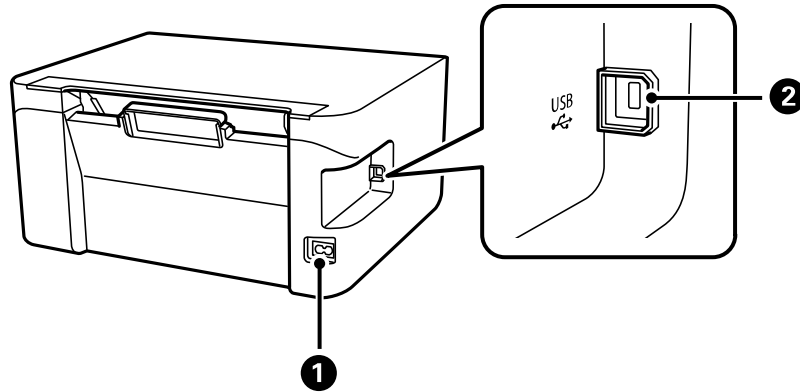

- 1 AC inlet
- 2 **USB** port

Parent topic: [Product Parts Locations](#)

## The Power Off and Sleep Timers

The product enters sleep mode or turns off automatically if it is not used for a period of time. You can adjust the time period before power management begins, but increasing the time reduces the product's energy efficiency.



[Changing the Power Off and Sleep Timer Settings - Windows](#)

[Changing the Power Off and Sleep Timer Settings - Mac](#)

Parent topic: [Product Basics](#)

## Changing the Power Off and Sleep Timer Settings - Windows

You can use the printer software to change the time period before the printer enters sleep mode or turns off automatically.

1. Access the Windows Desktop and right-click the  icon for your product in the right side of the Windows taskbar, or click the up arrow and right-click . Select **Printer Settings** and click the **Maintenance** tab.



2. Click the **Printer and Option Information** button.

You see this window:

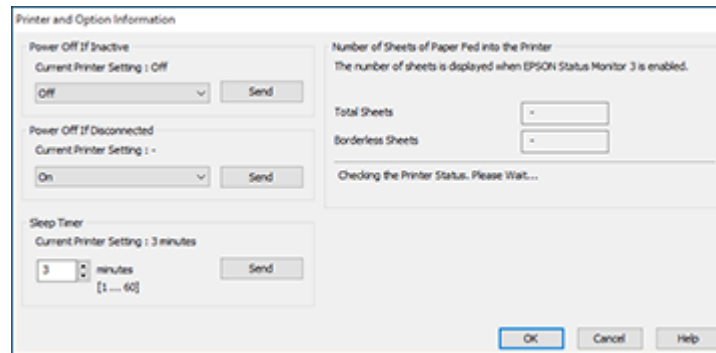

3. Select the time period you want as the **Power Off Timer** setting.

**Note:** Your product may have the **Power Off Timer** feature or **Power Off If Inactive** and **Power Off If Disconnected** features depending on the location of purchase.

4. Click **Send**.
5. Select the time period you want as the **Sleep Timer** setting.
6. Click **Send**.
7. Click **OK** to close the open program windows.

**Parent topic:** [The Power Off and Sleep Timers](#)

## Changing the Power Off and Sleep Timer Settings - Mac

You can use the printer software to change the time period before the printer enters sleep mode or turns off automatically.

1. In the Apple menu or the Dock, select **System Preferences**. Select **Print & Fax**, **Print & Scan**, or **Printers & Scanners**, select your product, and select **Options & Supplies**. Select **Utility** and select **Open Printer Utility**.
2. Select **Printer Settings**.

You see this screen:

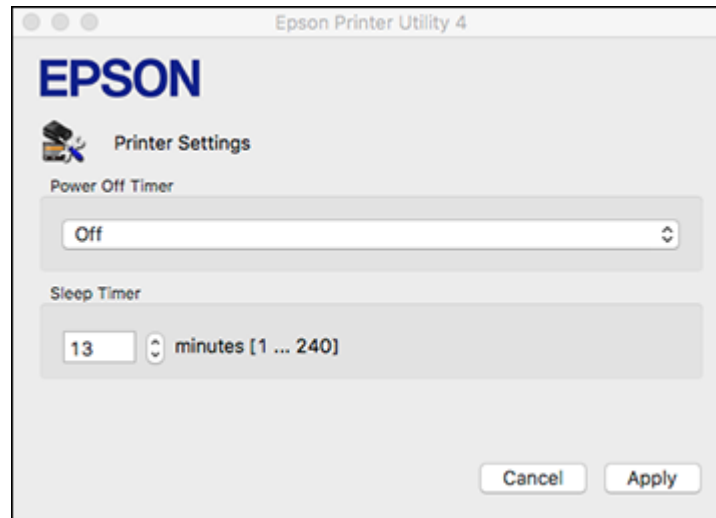

3. Select the time period you want as the **Power Off Timer** setting.
4. Select the time period you want as the **Sleep Timer** setting.
5. Click **Apply**.
6. If you see the confirmation message, click **Yes**, and close the Printer Settings window.

**Parent topic:** [The Power Off and Sleep Timers](#)

## Using the Epson Smart Panel Mobile App

Use this free Apple and Android app to set up your Epson product and then print, copy, or scan with your networked Epson product. Epson Smart Panel also lets you check product status.

1. Visit [latin.epson.com/connect](http://latin.epson.com/connect) to learn more about Epson Smart Panel and check the compatibility of your mobile device.
2. Download Epson Smart Panel from the Apple App Store or Google Play.
3. Connect your mobile device to the wireless network that you want to connect your product to or to the same wireless network as your product (if your product is already set up).

4. Do one of the following:
  - If you haven't set up your product, open Epson Smart Panel and follow the instructions to set up your product.
  - If your product is already set up, open Epson Smart Panel and select your Epson product, if necessary.

Now you are ready to print, copy, or scan with your mobile device and your Epson product.

**Parent topic:** [Product Basics](#)

**Related topics**

[Wi-Fi Networking](#)

## Epson Connect Solutions for Smartphones, Tablets, and More

Use your smartphone, tablet, or computer to print and scan documents, photos, emails, and web pages from your home, office, or even across the globe.

**Note:** If you are using your Epson product with the Windows 10 S operating system, you cannot use the software described in this section. You also cannot download and install any Epson product software from the Epson website for use with Windows 10 S; you must obtain software only from the Windows Store.

Print from anywhere with these Epson Connect solutions:

- Epson Email Print
- Epson Remote Print

Scan and send a file as an email or upload it to an online service directly from your Epson product with Epson Scan to Cloud.

[Using Epson Email Print](#)

[Using Epson Remote Print](#)

**Parent topic:** [Product Basics](#)

**Related tasks**

[Android Printing Using the Epson Print Enabler](#)

[Using Fire OS Printing](#)

[Using Windows 10 Mobile Printing](#)

[Using Epson Print and Scan App with Windows Tablets](#)

## Using Epson Email Print

With Epson Email Print, you can print from any device that can send email, such as your smartphone, tablet, or laptop. Just activate your product's unique email address. When you want to print, attach a PDF, Microsoft Office document, or photo to an email and send it to your product. Both the email and the attachments will print automatically.

1. Connect your product to your network. See the link below.
2. If you did not already set up Email Print when you installed your product software, visit [epsonconnect.com](http://epsonconnect.com) to learn more about Email Print, create your Epson Connect account, and register your product to the Epson Connect service.
3. Now you are ready to send and print emails to your product's Email Print address.

**Note:** Go to [epsonconnect.com](http://epsonconnect.com) and log into your Epson connect account to personalize your product's email, adjust print settings, and set up other Epson Connect services.

**Parent topic:** [Epson Connect Solutions for Smartphones, Tablets, and More](#)

### Related topics

[Wi-Fi Networking](#)

## Using Epson Remote Print

With Epson Remote Print software, you can print from your laptop or desktop computer to an Epson Email-enabled product anywhere in the world.

1. Connect your Epson product to your wireless network. See the link below.
2. If you did not already set up an Epson Connect account when you installed your product software, visit [epsonconnect.com](http://epsonconnect.com) to create your account and register your product to the Epson Connect service.

**Note:** Make a note of your product's email address.

3. Visit [epsonconnect.com](http://epsonconnect.com) to learn more about Remote Print and how to download the Remote Print Driver software.
4. Download and install the Remote Print software.
5. Enter the email address and optional access key of your Epson product during Remote Print setup.
6. Now you are ready to print remotely. Select the print command in your laptop or desktop computer application and choose the Remote Print option for your Epson product.

**Parent topic:** [Epson Connect Solutions for Smartphones, Tablets, and More](#)

**Related topics**

[Wi-Fi Networking](#)

## Setting Up Printing on a Chromebook

Your Epson printer supports native printing on Chromebook, allowing you to print from a Chromebook without drivers or cables.

For directions on setting up your printer, visit the [Setting Up Your Epson Printer on Your Chromebook](#) site.

**Parent topic:** [Product Basics](#)

## Android Printing Using the Epson Print Enabler

You can wirelessly print your documents, emails, photos, and web pages right from your Android phone or tablet (Android v4.4 or later). With a few taps, your Android device will discover your nearby Epson product and print.

1. Connect your Epson product to your wireless network. See the link below.
2. On your Android device, download the Epson Print Enabler plug-in from Google Play.
3. Go to **Settings** on your Android device, select **Printing**, and enable the Epson plug-in, if necessary.
4. Connect your Android device to the same wireless network as your product.
5. Now you are ready to print. From an Android application such as Chrome or Gmail, tap the menu icon and print whatever is on the screen.

**Note:** If you do not see your product, tap **All Printers** and select your product.

**Parent topic:** [Product Basics](#)

**Related topics**

[Wi-Fi Networking](#)

## Using Fire OS Printing

You can wirelessly print from Amazon Fire tablets and phones to your nearby networked Epson product. There is no software to download, no drivers to install, and no cables to connect. With just a few taps in Email, Calendar, Contacts, and WPS Office, you can send whatever is on the screen to an Epson product.

1. Connect your Epson product to your wireless network. See the link below.
2. Connect your Amazon device to the same wireless network as your product.
3. Now you are ready to print. From your Amazon application, tap the print option and select your product to print whatever is on the screen.

**Note:** If you see a message telling you that a plug-in is required, tap **OK** and tap **Download**. If your Amazon Fire product uses Fire OS 5 and above, your device automatically uses the built-in Mopria Print Service app to print.

**Parent topic:** [Product Basics](#)

**Related topics**

[Wi-Fi Networking](#)

## Using Windows 10 Mobile Printing

You can wirelessly print from Windows 10 Mobile tablets and phones to your nearby networked Epson product. There is no software to download, no drivers to install, and no cables to connect. Look for the print option in your Windows 10 application to send whatever is on the screen to an Epson product.

1. Connect your Epson product to your wireless network. See the link below.
2. Connect your Windows 10 Mobile device to the same wireless network as your product.
3. Now you are ready to print. From your Windows 10 application, tap the print option and select your product to print whatever is on the screen.

**Parent topic:** [Product Basics](#)

**Related topics**

[Wi-Fi Networking](#)

## Using Epson Print and Scan App with Windows Tablets

You can use this free app to print photos and scan from your Windows (Windows 8 or higher) Surface RT or Pro tablet with networked Epson products. The Epson Print and Scan app allows you to scan and capture images right to your tablet or to Microsoft OneDrive.

**Note:** The Epson Print and Scan app does not support Windows 10 Mobile printing and does not supply scanning functions for products without scanners.

1. Connect your Epson product to your wireless network. See the link below.

2. Download the Epson Print and Scan app from the Microsoft Windows Store.
3. Connect your Windows tablet to the same wireless network as your product.
4. Open the Epson Print and Scan app and select your Epson product.

Now you are ready to print photos or scan.

**Parent topic:** [Product Basics](#)

**Related topics**

[Wi-Fi Networking](#)

---

# Wi-Fi Networking

See these sections to use your product on a Wi-Fi network.

[Network Security Recommendations](#)

[Wi-Fi Direct Mode Setup](#)

[Wi-Fi Protected Setup \(WPS\)](#)

[Printing a Network Status Sheet](#)

[Printing a Network Connection Report](#)

[Changing or Updating Network Connections](#)

## Network Security Recommendations

To help deter unauthorized access to your product over a network, you should protect your network environment using appropriate security measures.

Security measures such as these can help deter threats such as loss of user data, use of telephone and fax lines, and other intrusions:

- **Enable security on your wireless LAN**

Enable the appropriate security on the wireless LAN you plan to use with your product. Network security such as a network password can deter interception of traffic over the wireless LAN. Your router may already have a default password enabled by your Internet service provider (ISP). See your ISP and router documentation for instructions on how to change the default password and better secure your network.

- **Connect your product only to a network protected by a firewall**

Connecting your product directly to the Internet may leave it vulnerable to security threats. Instead, connect it to a router or other network connection protected by a firewall. Your router may already have a firewall set up by your Internet service provider; check with your ISP for confirmation. For best results, set up and use a private IP address for your network connection.

- **Change the default administrator password on your product**

If your product has an option to set an administrator password, change the default administrator password to deter access by unauthorized users to personal data stored on your product, such as IDs, passwords, and contact lists.

Parent topic: [Wi-Fi Networking](#)



## Wi-Fi Direct Mode Setup

You can set up your product to communicate directly with your computer or another device without requiring a wireless router or access point. In Wi-Fi Direct Mode, the product itself acts as a network access point for up to 8 devices.

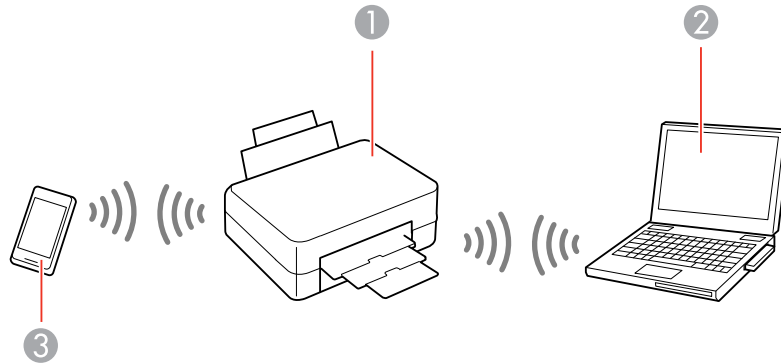

- 1 Epson product
- 2 Computer with a wireless interface
- 3 Other wireless device



[Enabling Wi-Fi Direct Mode](#)



**Parent topic:** [Wi-Fi Networking](#)

## Enabling Wi-Fi Direct Mode

You can enable Wi-Fi Direct mode to allow direct communication between your product and computer or other devices without a wireless router or access point. Make sure paper is loaded before you begin.

**Note:** If you are printing from a computer, make sure you installed the network software as described on the *Start Here* sheet.

1. Hold down the **Wi-Fi** button and press the  network status button until the  Wi-Fi light and  Wi-Fi Direct light flash alternately. Then release both buttons.

**Note:** When you are using an Android device and connect to the printer using Wi-Fi Direct, the  Wi-Fi light and  Wi-Fi Direct light flash simultaneously on the printer.

After both lights stop flashing, the  Wi-Fi Direct light remains on.

2. Hold down the  network status button for about seven seconds to print a network status sheet.
3. Use your computer or wireless device to select the Wi-Fi network name (SSID) and password listed in the Wi-Fi Direct section of the network status sheet.

You should now be able to print to your product directly from your computer or device. If you cannot print successfully, repeat the process above and make sure you enter the password exactly as written on the network status sheet.

**Parent topic:** [Wi-Fi Direct Mode Setup](#)

## Wi-Fi Protected Setup (WPS)

If your network uses a WPS-enabled wireless router or access point, you can quickly connect your product to the network using Wi-Fi Protected Setup (WPS).

**Note:** To check if your router is WPS-enabled, look for a button labeled **WPS** on your router or access point. If there is no hardware button, there may be a virtual WPS button in the software for the device. Check your network product documentation for details.

[Using WPS to Connect to a Network](#)



**Parent topic:** [Wi-Fi Networking](#)

## Using WPS to Connect to a Network

If you have a WPS-enabled router or access point, you can use Wi-Fi Protected Setup (WPS) to connect your device to the network.

**Note:** To check if your router is WPS-enabled, look for a button labeled **WPS** on your router or access point. If there is no hardware button, there may be a virtual WPS button in the software for the device. Check your network product documentation for details.

1. Press the **WPS** button on your router or access point.

2. Hold down the **Wi-Fi** button on your product for about five seconds until the  Wi-Fi light and  Wi-Fi Direct light flash alternately.

The  Wi-Fi light turns green to indicate a successful connection.

**Note:** Be sure to press and hold the **Wi-Fi** button on your product within 2 minutes of pressing the **WPS** button on your router or access point.

**Parent topic:** [Wi-Fi Protected Setup \(WPS\)](#)

**Related references**

[Product Light Status](#)

## Printing a Network Status Sheet

You can print a network status sheet to help you determine the causes of any problems you may have using your product on a network.

To print the status sheet, hold down the  network status button on the product for at least seven seconds.

**Note:** If you release the button before seven seconds elapses, a network connection report is printed instead of a network status sheet.

Examine the settings shown on the network status sheet to diagnose any problems you may have.

**Parent topic:** [Wi-Fi Networking](#)

## Printing a Network Connection Report

You can print a network connection report that provides details of the connection between the product and the wireless router.

**Note:** The network connection report may be printed in a different language depending on your region, and cannot be changed.

1. To print the network connection report, press the  network status button on the product.
2. Review the information contained in the report and resolve any errors.

[Network Connection Report Codes and Messages](#)

**Parent topic:** [Wi-Fi Networking](#)

## Network Connection Report Codes and Messages

Check the error codes and messages on the network connection report to solve problems you may encounter with network connections. The tables here list solutions to problems based on the error codes and messages that may appear on the top of the report.

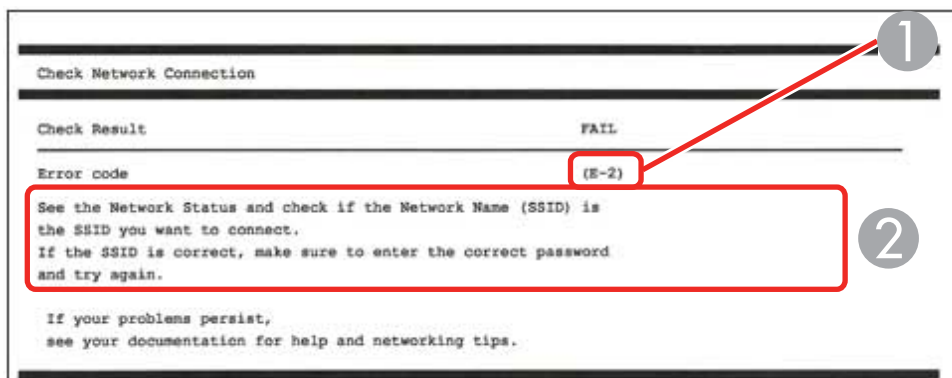

- 1 Error code
- 2 Message

**Note:** Error codes and messages listed here may not all apply to your product.

### Error Codes and Messages

| Error code and message  | Solution   |
|---|--|
| <b>E-1</b><br>Confirm that the network cable is connected and network devices such as hub, router, or access point are turned on. | Make sure your router, access point, and/or hub are turned on, and the network cable is securely connected to your device and to your product.<br><br>If you are trying to set up Wi-Fi, remove the network cable and set up Wi-Fi again. Ethernet and Wi-Fi cannot be connected at the same time. |

| Error code and message   | Solution   |
|--|--|
| <p><b>E-2, E-3, or E-7</b></p> <p>No wireless network names (SSID) found. Confirm that the router/access point is turned on and the wireless network (SSID) is set up correctly. Contact your network administrator for assistance.</p> <p>No wireless network names (SSID) found. Confirm that the wireless network name (SSID) of the PC you wish to connect is set up correctly. Contact your network administrator for assistance.</p> <p>Entered security key/password does not match the one set for your router/access point. Confirm security key/password. Contact your network administrator for assistance.</p> | <p>Check the following:</p> <ul style="list-style-type: none"> <li>• Make sure your router or access point is turned on, and is correctly connected to your computer or network device.</li> <li>• Turn off the router or access point, wait about 10 seconds, and turn it on again.</li> <li>• Move your product closer to your router or access point, and remove any obstacles between them. Also move your product away from devices such as wireless phones or microwaves.</li> <li>• Confirm that the SSID shown on the network connection report matches the label on your router or access point. Also make sure your SSID uses only ASCII characters and symbols, or your product cannot display the SSID correctly.</li> <li>• If you are trying to connect using the WPS push button method, make sure your router or access point supports it.</li> <li>• If you are using a network password, check the label on your router or access point to confirm that you are using the correct password, or check with your network administrator or router/access point documentation.</li> <li>• If you are connecting to a smart device that generates an SSID, check the device documentation for the SSID and password you should use.</li> <li>• If your wireless connection suddenly disconnects, and another smart device was added to the network using a WPS push button method or your network was set up using a non-WPS push button method, try downloading and installing your product software again.</li> </ul> |

| Error code and message   | Solution   |
|--|--|
| <p><b>E-5</b><br/>Security mode (e.g. WEP, WPA) does not match the current setting of the printer. Confirm security mode. Contact your network administrator for assistance.</p>   | <p>If the security on your router or access point is not one of the following types, change the type of security on your router or access point and reset your product's network settings.</p> <ul style="list-style-type: none"> <li>• WEP-64 bit (40 bit)</li> <li>• WEP-128 bit (104 bit)</li> <li>• WPA PSK (TKIP/AES); also known as WPA Personal</li> <li>• WPA2 PSK (TKIP/AES); also known as WPA2 Personal</li> <li>• WPA (TKIP/AES)</li> <li>• WPA2 (TKIP/AES)</li> <li>• WPA3-SAE (AES)</li> </ul>   |
| <p><b>E-6</b><br/>MAC address of your printer may be filtered. Check whether your router/access point has restrictions such as MAC address filtering. See the documentation of the router/access point or contact your network administrator for assistance.</p> | <p>If your router or access point has MAC address filtering enabled, register your product's MAC address so it is not filtered. Locate the MAC address on the network connection report and check your router or access point documentation for instructions.</p> <p>If your router or access point is using shared authentication with WEP security, confirm that you are using the correct authentication key and index.</p> <p>If your router or access point limits the number of connected devices, raise the connection limit. See your router or access point documentation for instructions.</p> |
| <p><b>E-8</b><br/>Incorrect IP address is assigned to the printer. Confirm IP address setup of the network device (hub, router, or access point). Contact your network administrator for assistance.</p>   | <p>If your product's <b>Obtain IP Address</b> setting is set to <b>Auto</b>, enable DHCP on your router or access point. If it is set to <b>Manual</b>, the IP address may be out of range or on a different network segment; set a valid IP address using your product control panel or the Web Config utility.</p> <p>You can also try turning off your product and the router or access point, waiting about 10 seconds, and turning them on again.</p>   |

| Error code and message   | Solution  |
|--|---|
| <p><b>E-9</b><br/>Confirm the connection and network setup of the PC or other device. Connection using the EpsonNet Setup is available. Contact your network administrator for assistance.</p> | <p>Make sure your computer or network device are turned on. Also make sure that you can access the Internet and other devices on the same network from the devices you are trying to connect to your product.</p> <p>If you still cannot connect to your product, turn off your router or access point, wait about 10 seconds, and turn it on again. Download and install your product software again to reset your network settings.</p>   |
| <p><b>E-10</b><br/>Confirm IP address, subnet mask, and default gateway setup. Connection using the EpsonNet Setup is available. Contact your network administrator for assistance.</p>        | <p>Make sure other devices on the network are turned on and do the following:</p> <ul style="list-style-type: none"> <li>• If your product's <b>Obtain IP Address</b> setting is set to <b>Manual</b>, check the IP address, subnet mask, and default gateway addresses on the network connection report to see if they are correct. If not, correct the settings.</li> <li>• If DHCP is enabled, set your product's <b>Obtain IP Address</b> setting to <b>Auto</b>. If you want to use the DHCP-assigned address as a static address, set the <b>Obtain IP Address</b> setting to <b>Manual</b>, enter the product's IP address as listed on the network connection report, and set the subnet mask to 255.255.255.0.</li> </ul> <p>If you still cannot connect to your product, turn off your router or access point, wait about 10 seconds, and turn it on again.</p> |
| <p><b>E-11</b><br/>Setup is incomplete. Confirm default gateway setup. Connection using the EpsonNet Setup is available. Contact your network administrator for assistance.</p>                | <p>If you set your product's <b>TCP/IP Setup</b> setting to <b>Manual</b>, check that the default gateway address listed on the network connection report is correct. Also turn on the device that is set as the default gateway.</p>   |

| Error code and message   | Solution  |
|--|---|
| <p><b>E-12</b></p> <p>Confirm the following:</p> <ul style="list-style-type: none"> <li>-Entered security key/password is correct</li> <li>-Index of the security key/password is set to the first number</li> <li>-IP address, subnet mask, or default gateway setup is correct</li> </ul> <p>Contact your network administrator for assistance.</p>      | <p>Make sure other devices on the network are turned on and do the following:</p> <ul style="list-style-type: none"> <li>• Make sure the IP address, subnet mask, and default gateway addresses are correct, if you are entering them manually.</li> <li>• Confirm that the subnet mask and default gateway addresses for other devices are the same.</li> <li>• Make sure the IP address does not conflict with other devices.</li> </ul> <p>If you still cannot connect to your product, do the following:</p> <ul style="list-style-type: none"> <li>• Turn off your router or access point, wait about 10 seconds, and turn it on again.</li> <li>• Download and install your product software again to reset your network settings.</li> <li>• If your router or access point uses WEP security with several registered passwords, make sure that the first registered password is set on your product.</li> </ul> |
| <p><b>E-13</b></p> <p>Confirm the following:</p> <ul style="list-style-type: none"> <li>-Entered security key/password is correct</li> <li>-Index of the security key/password is set to the first number</li> <li>-Connection and network setup of the PC or other device is correct</li> </ul> <p>Contact your network administrator for assistance.</p> | <p>Make sure your router, access point, and/or hub are turned on. Also make sure the TCP/IP setup on your router, access point, and/or hub is not set manually; this may cause your product's network settings to differ from the manually set up devices.</p> <p>If you still cannot connect to your product, do the following:</p> <ul style="list-style-type: none"> <li>• Turn off your router or access point, wait about 10 seconds, and turn it on again.</li> <li>• Download and install your product software again to reset your network settings.</li> <li>• If your router or access point uses WEP security with several registered passwords, make sure that the first registered password is set on your product.</li> </ul>   |



## Network Environment Messages

| Message  | Solution  |
|--|---|
| The Wi-Fi environment needs to be improved. Turn the wireless router off and then turn it on. If the connection does not improve, see the documentation for the wireless router. | Move your product closer to your router or access point, and remove any obstacles between them. Then turn off your router or access point, wait about 10 seconds, and turn it back on again. If you still cannot connect to your product, check the documentation that came with your router or access point for solutions. |
| *No more devices can be connected. Disconnect one of the connected devices if you want to add another one.   | You can connect up to 8 computers or other devices to your product using a Wi-Fi Direct (Simple AP) connection. If you want to add another device, disconnect an existing connected device first.   |

Parent topic: [Printing a Network Connection Report](#)

## Changing or Updating Network Connections

See these sections to change or update how your product connects to a network.

[Accessing the Web Config Utility](#)

[Changing a USB Connection to a Wi-Fi Connection](#)

[Connecting to a New Wi-Fi Router](#)

[Disabling Wi-Fi Features](#)

Parent topic: [Wi-Fi Networking](#)

## Accessing the Web Config Utility

You can select your product's network settings and confirm its operating status using a web browser. You do this by accessing your product's built-in Web Config utility from a computer or other device that is connected to the same network as your product.

1. Print a network status sheet.
2. Locate the IP address for your product that is listed on the network status sheet.
3. On a computer or other device connected to the same network as your product, open a web browser.
4. Enter your product's IP address into the address bar.

You see the available Web Config utility options.

**Parent topic:** [Changing or Updating Network Connections](#)

**Related tasks**

[Printing a Network Status Sheet](#)

## Changing a USB Connection to a Wi-Fi Connection

If you have already connected your product to your computer using a USB connection, you can change to a Wi-Fi connection.

1. Disconnect the USB cable from your product.
2. Uninstall your product software.
3. Download and install your product software from the Epson website using the instructions on the *Start Here* sheet.

**Parent topic:** [Changing or Updating Network Connections](#)

**Related concepts**

[Uninstall Your Product Software](#)

## Connecting to a New Wi-Fi Router

If you change the wireless router you have been using on your network, you need to update your product's Wi-Fi connection to the new router.

**Note:** If you switch to a 5 GHz wireless router, set the router to operate in dual band (2.4 GHz and 5 GHz) mode. If your router uses a single network name (SSID) for both the 2.4 GHz and 5 GHz band, give each band its own network name (SSID) instead, such as Home Network 2.4 GHz and Home Network 5 GHz. See your router documentation for instructions.

1. Do one of the following:
  - **Windows:** Uninstall your product software.
  - **Mac:** Go to the next step.
2. Download and install your product software from the Epson website using the instructions on the *Start Here* sheet.

**Parent topic:** [Changing or Updating Network Connections](#)





**Related concepts**

[Uninstall Your Product Software](#)

## Disabling Wi-Fi Features

You may need to disable your product's Wi-Fi features if you change your network connection type or need to solve a problem with your network connection. You can disable the Wi-Fi features by resetting the network settings to their default values.

**Note:** Before disabling Wi-Fi features, make a note of your product's SSID (network name) and password, and any network settings selected for the Epson Connect services you may use. These settings will be reset to their default values.

1. Turn off the product.
2. Hold down the  network status button and press the  power button until the  Wi-Fi light and  Wi-Fi Direct light flash alternately. Then release both buttons.

When the  Wi-Fi light and  Wi-Fi Direct light turn off, Wi-Fi is disabled.

**Parent topic:** [Changing or Updating Network Connections](#)

---

# Loading Paper

Before you print, load paper for the type of printing you will do.

[Loading Paper in the Sheet Feeder](#)

[Paper Loading Capacity](#)

[Double-sided Printing Capacity](#)

[Compatible Epson Papers](#)

[Borderless Paper Type Compatibility](#)

[Paper or Media Type Settings](#)

## Loading Paper in the Sheet Feeder

You can print documents and photos on a variety of paper types and sizes.

1. Flip the feeder guard forward, then raise the paper support.

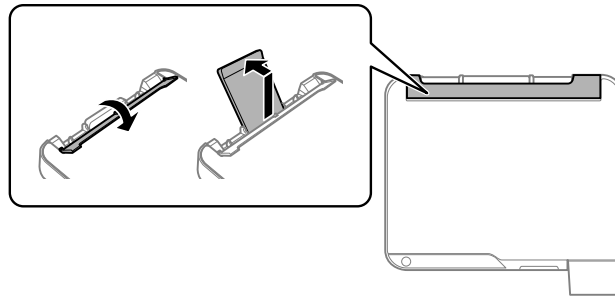

2. Slide the edge guides out all the way.

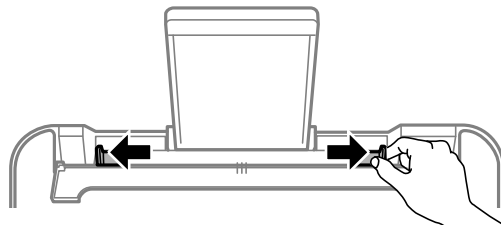

3. Pull out the output tray and open the paper stopper.

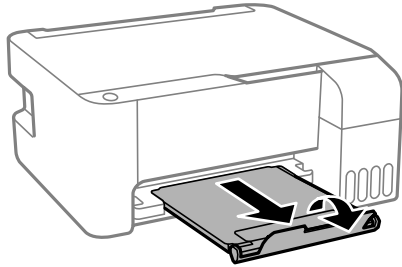

4. If you are inserting a stack of paper, fan the sheets first and tap the stack on a flat surface to even the edges.

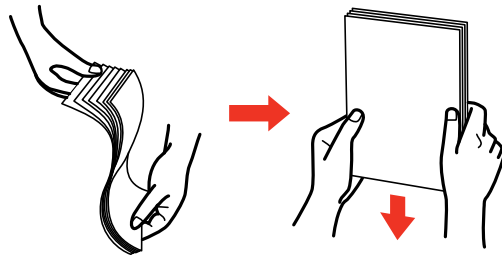

**Note:** Do not fan or curl photo paper.

5. Do one of the following:
  - Insert paper, glossy or printable side up and short edge first, in the center of the paper support.

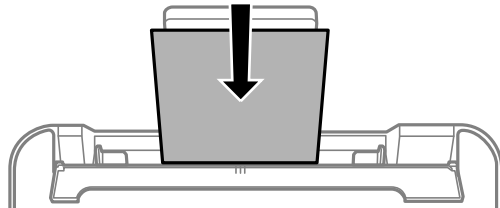

- Load up to 10 envelopes in the center of the paper support. Load them printable side up and flap edge left.

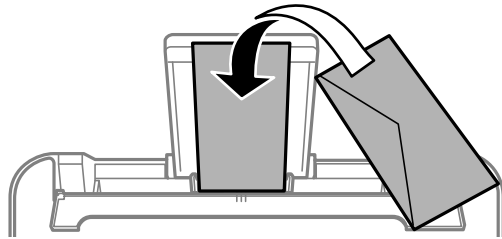

- Load a sheet of loose-leaf or other paper with holes facing as shown.

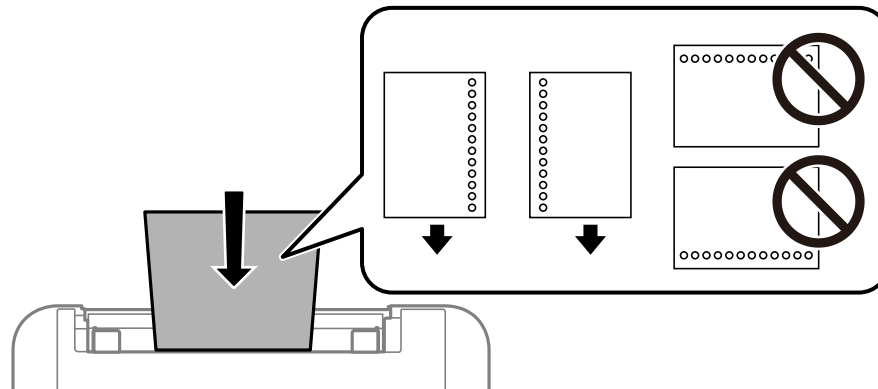

- To load a sheet of paper longer than legal size, close the paper support and flatten the leading edge of the paper as shown.

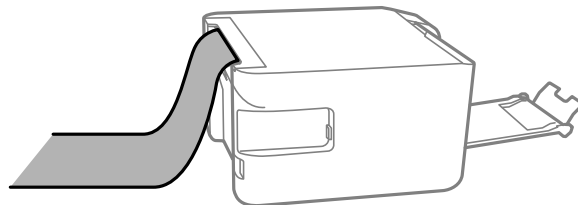

6. Slide the edge guides against the paper, but not too tightly. Then flip the feeder guard back.

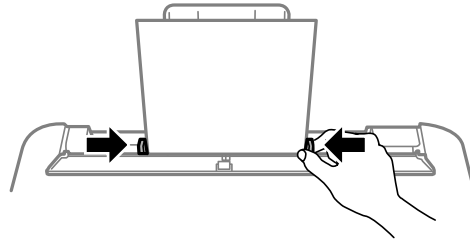

Always follow these paper loading guidelines:

- Load only the recommended number of sheets.
- Load paper short edge first, no matter which way your document faces.
- Load letterhead or pre-printed paper top edge first.
- Do not load paper above the arrow mark inside the edge guide.
- If you have trouble loading a stack of envelopes, press each envelope flat before loading it or load one envelope at a time.
- Do not load envelopes that are curled, folded, or too thin, or that have plastic windows or exposed adhesive flaps.
- Check the paper package for any additional loading instructions.
- Do not place objects on the feeder guard. Doing so may prevent paper from feeding.
- Do not leave paper in the printer as the paper may curl or the print quality may decline.
- If you use paper with binder holes, load only one sheet at a time in only these sizes: Letter (8.5 × 11 inches [216 × 279 mm]), A4 (8.3 × 11.7 inches [210 × 297 mm]), or Legal (8.5 × 14 inches [216 × 356 mm]).

**Parent topic:** [Loading Paper](#)

**Related references**

[Paper Loading Capacity](#)

[Paper Specifications](#)

## Paper Loading Capacity

| Paper type   | Loading capacity   |
|--|--|
| Plain paper<br>Copy paper  | Letter (8.5 × 11 inches [216 × 279 mm]), A4 (8.3 × 11.7 inches [210 × 297 mm]), Executive (7.25 × 10.5 inches [184 × 267 mm]), Half Letter (5.5 × 8.5 inches [140 × 216 mm]), or A6 (4.1 × 5.8 inches [105 × 148 mm]) size: 100 sheets |
|  | Legal (8.5 × 14 inches [216 × 356 mm]), 8.5 × 13 inches (216 × 330 mm), Mexico-Oficio (8.5 × 13.4 inches [216 × 340 mm]), or Oficio 9 (8.46 × 12.4 inches [215 × 315 mm]) size: 1 sheet  |
| Epson Presentation Paper Matte<br>Epson High Quality Ink Jet Paper   | 80 sheets  |
| Epson Premium Presentation Paper Matte<br>Epson Photo Paper Glossy<br>Epson Premium Photo Paper Glossy<br>Epson Ultra Premium Photo Paper Glossy<br>Epson Premium Photo Paper Semi-gloss<br>Epson Value Photo Paper Glossy | 20 sheets<br>If paper feeds incorrectly, or printing is uneven or smeared, load 1 sheet at a time.   |
| Epson Premium Presentation Paper Matte<br>Double-sided   | 1 sheet  |
| Envelopes  | 10 envelopes   |

Parent topic: [Loading Paper](#)

## Double-sided Printing Capacity

You can print double-sided on the paper types and sizes listed here.



| Paper type  | Size  | Double-sided printing capacity |
|---|---|--------------------------------|
| Plain paper<br>Copy paper                           | Letter (8.5 × 11 inches [216 × 279 mm]), A4 (8.3 × 11.7 inches [210 × 297 mm]), Executive (7.25 × 10.5 inches [184 × 267 mm]), Half Letter (5.5 × 8.5 inches [140 × 216 mm]), or A6 (4.1 × 5.8 inches [105 × 148 mm]) | 30 sheets                      |
|   | Legal (8.5 × 14 inches [216 × 356 mm]), Mexico-Oficio (8.5 × 13.4 inches [216 × 340 mm]), 8.5 × 13 inches (216 × 330 mm), Oficio 9 (8.46 × 12.4 inches [215 × 315 mm]), or User-defined sizes                         | 1 sheet                        |
| Epson Premium Presentation Paper Matte Double-sided | Letter (8.5 × 11 inches [216 × 279 mm])   | 1 sheet                        |

You cannot print double-sided on the following paper types:

- Epson High Quality Ink Jet Paper
- Epson Presentation Paper Matte
- Epson Photo Paper Glossy
- Epson Value Photo Paper Glossy
- Epson Premium Photo Paper Glossy
- Epson Premium Photo Paper Semi-gloss
- Epson Ultra Premium Photo Paper Glossy
- Epson Premium Presentation Paper Matte
- Envelopes

**Parent topic:** [Loading Paper](#)

## Compatible Epson Papers

You can purchase genuine Epson ink and paper from an Epson authorized reseller. To find the nearest reseller, visit [latin.epson.com](http://latin.epson.com) or call your nearest Epson sales office.

**Note:** Paper/media availability varies by country.

| <b>Paper Type</b>                      | <b>Size</b>                                | <b>Part number</b>    | <b>Sheet count</b> |
|--|--|-----------------------|--------------------|
| Epson High Quality Ink Jet Paper       | A4 (8.3 × 11.7 inches<br>[210 × 297 mm])   | S041117               | 100                |
|  | Letter (8.5 × 11 inches<br>[216 × 279 mm]) | S041111               | 100                |
| Epson Photo Paper Glossy               | 4 × 6 inches (102 × 152 mm)                | S041809               | 50                 |
|  |  | S042038               | 100                |
|  | A4 (8.3 × 11.7 inches<br>[210 × 297 mm])   | S041140               | 20                 |
|  | Letter (8.5 × 11 inches<br>[216 × 279 mm]) | S041141               | 20                 |
| Epson Premium Photo Paper Glossy       | 4 × 6 inches (102 × 152 mm)                | S041727               | 100                |
|  | 5 × 7 inches (127 × 178 mm)                | S041464               | 20                 |
|  | 8 × 10 inches (203 × 254 mm)               | S041465               | 20                 |
|  | Letter (8.5 × 11 inches<br>[216 × 279 mm]) | S041286-ML<br>S041667 | 20<br>50           |
| Epson Ultra Premium Photo Paper Glossy | 4 × 6 inches (102 × 152 mm)                | S042181<br>S042174    | 60<br>100          |
|  | 5 × 7 inches (127 × 178 mm)                | S041945               | 20                 |
|  | 8 × 10 inches (203 × 254 mm)               | S041946               | 20                 |
|  | Letter (8.5 × 11 inches<br>[216 × 279 mm]) | S042182<br>S042175    | 25<br>50           |
|  |  |                       |                    |
| Epson Premium Photo Paper Semi-gloss   | 4 × 6 inches (102 × 152 mm)                | S041982               | 40                 |
|  | Letter (8.5 × 11 inches<br>[216 × 279 mm]) | S041331-ML            | 20                 |
| Epson Presentation Paper Matte         | Letter (8.5 × 11 inches<br>[216 × 279 mm]) | S041257-ML            | 50                 |

| Paper Type  | Size                                    | Part number | Sheet count |
|---|---|-------------|-------------|
| Epson Premium Presentation Paper Matte              | 8 × 10 inches (203 × 254 mm)            | S041467     | 50          |
|   | Letter (8.5 × 11 inches [216 × 279 mm]) | S041257-ML  | 50          |
| Epson Premium Presentation Paper Matte Double-sided | Letter (8.5 × 11 inches [216 × 279 mm]) | S041568     | 50          |
| Epson Value Photo Paper Glossy                      | Letter (8.5 × 11 inches [216 × 279 mm]) | S400031     | 50          |
|   | 4 × 6 inches (102 × 152 mm)             | S400032     | 20          |
|   |   | S400033     | 50          |
|   |   | S400034     | 100         |

Parent topic: [Loading Paper](#)

## Borderless Paper Type Compatibility

You can print borderless photos on compatible paper types in compatible sizes:

### Borderless Paper Types

- Epson Premium Photo Paper Glossy
- Epson Ultra Premium Photo Paper Glossy
- Epson Photo Paper Glossy
- Epson Premium Photo Paper Semi-gloss
- Epson Value Photo Paper Glossy

### Borderless Paper Sizes

4 × 6 inches (102 × 152 mm)

Parent topic: [Loading Paper](#)

## Paper or Media Type Settings

| For this paper  | Select this paper Type or Media Type setting |
|---|--|
| Plain paper<br>Copy paper<br>Epson Presentation Paper Matte<br>Epson High Quality Ink Jet Paper | Plain Paper / Bright White Paper             |
| Epson Ultra Premium Photo Paper Glossy  | Ultra Premium Photo Paper Glossy             |
| Epson Premium Photo Paper Glossy  | Premium Photo Paper Glossy                   |
| Epson Photo Paper Glossy<br>Epson Value Photo Paper Glossy                                      | Photo Paper Glossy                           |
| Epson Premium Photo Paper Semi-gloss  | Premium Photo Paper Semi-Gloss               |
| Epson Premium Presentation Paper Matte<br>Epson Premium Presentation Paper Matte Double-sided   | Premium Presentation Paper Matte             |
| Envelopes   | Envelope                                     |

Parent topic: [Loading Paper](#)

---

## Placing Originals on the Product

Follow the instructions here to place your original documents or photos on the product.

**Caution:** Do not place anything on top of your product or use its cover as a writing surface to avoid damaging it.

[Placing Originals on the Scanner Glass](#)

### Placing Originals on the Scanner Glass

You can place originals up to this size on the scanner glass: Letter (8.5 × 11 inches [216 × 279 mm]) or A4 (8.3 × 11.7 inches [210 × 297 mm]).

1. Open the document cover.

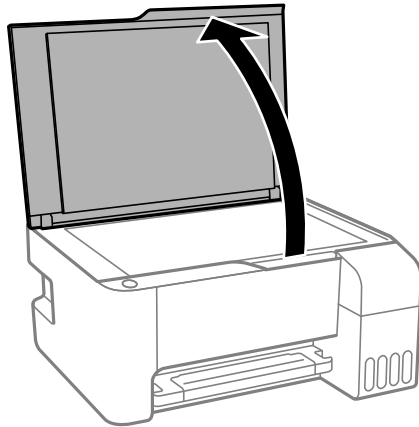

**Note:** If there is any dust or dirt on the scanner glass, the scanning range may expand to include it, so the image of the original may be displaced or reduced. Remove any dust and dirt on the scanner glass before scanning.

2. Place your original facedown on the scanner glass with the top facing into the corner. Slide the original to the edges of the indicated corner.

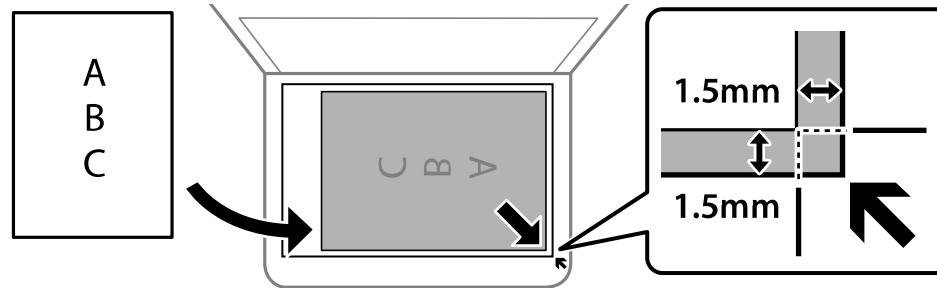

**Note:** You can place multiple originals on the scanner glass. Just make sure they are at least 0.2 inch (4.5 mm) away from the edge of the scanner glass and at least 0.8 inch (20 mm) away from each other.

**Note:** The edges of your original may be cropped by 0.06 inch (1.5 mm) from the edge of the scanner glass. Manually position your original away from the edges to prevent cropping.

**Note:** When placing bulky originals such as books, prevent exterior light from shining directly onto the scanner glass.

3. Close the document cover gently to keep your original in place.

**Caution:** Do not push down on the document cover or scanner glass or you may damage the product.

Remove your originals after scanning. If you leave the originals on the scanner glass for a long time, they may stick to the glass surface.

**Parent topic:** [Placing Originals on the Product](#)

#### **Related topics**

[Copying](#)

[Scanning](#)

---

# Copying





See the information here to copy documents or photos using your product.

**Note:** Copies may not be exactly the same size as your originals.

[Changing the Default Paper Size using the Control Panel](#)  
[Copying Documents or Photos](#)

## Changing the Default Paper Size using the Control Panel





Depending on your region, the default paper size for copies is either A4 (8.3 × 11.7 inches [210 × 297 mm]) or Letter (8.5 × 11 inches [216 × 279 mm]).



- To change the default paper size to A4 (8.3 × 11.7 inches [210 × 297 mm]), make sure the product is turned off, then hold down the  color copy button and press the  power button to turn the product on. When the product turns on, release both buttons.
- To change the default paper size to Letter (8.5 × 11 inches [216 × 279 mm]), make sure the product is turned off, then hold down the  B&W copy button and press the  power button to turn the product on. When the product turns on, release both buttons.

**Parent topic:** [Copying](#)

## Copying Documents or Photos

You can copy color or black-and-white documents or photos onto plain paper.

1. Place your original document or photo on the scanner glass.
2. Load plain paper in one of these sizes: Letter (8.5 × 11 inches [216 × 279 mm]) or A4 (8.3 × 11.7 inches [210 × 297 mm]).
3. Do one of the following to start copying:
  - To copy a black-and-white original, press the  B&W copy button.
  - To copy a color original, press the  color copy button.
  - To copy a black-and-white or color original in draft mode, press the  B&W copy button or the  color copy button and the  stop button at the same time.

- To make more than one copy, repeatedly press the  B&W copy button or the  color copy button for the number of copies you need (up to 20 copies). For example, to make 4 copies, press the button four times. Make sure you press the button in intervals of less than one second.

**Note:** Margins with a width of 3 mm appear around the edges of the paper.

The product scans and prints your copy.

**Note:** To cancel copying, press the  stop button.

**Parent topic:** [Copying](#)



---

# Printing from a Computer

Before printing from your computer, make sure you have set up your product and installed its software as described on the *Start Here* sheet.

**Note:** If you have an Internet connection, it is a good idea to check for updates to your product software on Epson's support website. If you see a Software Update screen, select **Enable automatic checking** and click **OK**. The update scans your system to see if you have the latest product software. Follow the on-screen instructions.

[Printing with Windows](#)

[Printing with the Built-in Epson Driver - Windows 10 S](#)

[Printing on a Mac](#)

[Printing from a Smartphone or Tablet](#)

[Printing with Epson Photo+](#)

[Cancelling Printing Using a Product Button](#)

## Printing with Windows

You can print with your product using any Windows application, as described in these sections.

**Note:** If you are using your Epson product with the Windows 10 S operating system, you cannot use the software described in this section. You also cannot download and install any Epson product software from the Epson website for use with Windows 10 S; you must obtain software only from the Windows Store.

[Selecting Basic Print Settings - Windows](#)

[Selecting Double-sided Printing Settings - Windows](#)

[Selecting Additional Layout and Print Options - Windows](#)

[Selecting a Printing Preset - Windows](#)

[Selecting Extended Settings - Windows](#)

[Printing Your Document or Photo - Windows](#)

[Checking Print Status - Windows](#)

[Locking Printer Settings - Windows](#)

[Selecting Default Print Settings - Windows](#)

[Changing Automatic Update Options](#)

Parent topic: [Printing from a Computer](#)

## Selecting Basic Print Settings - Windows

Select the basic settings for the document or photo you want to print.

1. Open a photo or document for printing.
2. Select the print command in your application.

**Note:** You may need to select a print icon on your screen, the **Print** option in the **File** menu, or another command. See your application's help utility for details.

3. If necessary, select your product name as the printer you want to use.

**Note:** You may also need to select **Properties** or **Preferences** to view your print settings.

You see the Main tab of your printer settings window:

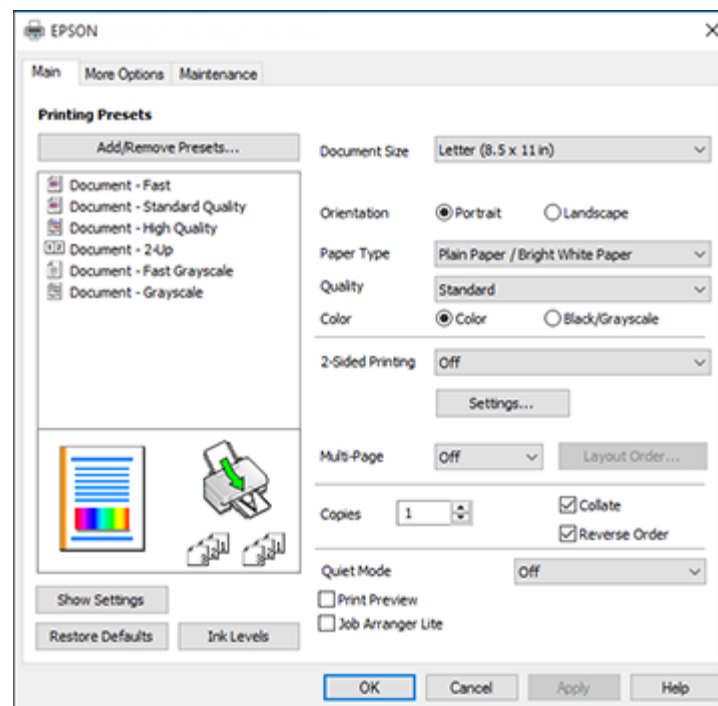

4. Select the size of the paper you loaded as the **Document Size** setting.

**Note:** You can also select the **User-Defined** setting to create a custom paper size.

5. If you are printing a borderless photo, select **Borderless**. You can click **Settings** to access additional options for borderless printing.

**Note:** You must select a compatible borderless paper type and size to print without borders. Check the borderless paper compatibility list for details.

6. Select the orientation of your document.

**Note:** If you are printing an envelope, select **Landscape**.

7. Select the type of paper you loaded as the **Paper Type** setting.

**Note:** The setting may not exactly match the name of your paper. Check the paper type settings list for details.

8. Select the **Quality** setting that matches the print quality you want to use.

9. Select a Color option:

- To print a color document or photo, select the **Color** setting.
- To print text and graphics in black or shades of gray, select the **Black/Grayscale** setting.

10. To print on both sides of the paper, select a **2-Sided Printing** option.

11. To print multiple pages on one sheet of paper, or print one image on multiple sheets of paper, select one of the settings in the **Multi-Page** menu and select the printing options you want.

12. To print multiple copies and arrange their print order, select the **Copies** options.

13. To reduce noise during printing when you select **Plain Paper/Bright White Paper**, turn on **Quiet Mode** (printing will be slower).

14. To preview your job before printing, select **Print Preview**.

15. To save your print job as a project that can be modified and combined with other print jobs, select **Job Arranger Lite**.

[Print Quality Options - Windows](#)

[Multi-Page Printing Options - Windows](#)

**Parent topic:** [Printing with Windows](#)

**Related references**

[Paper or Media Type Settings](#)

[Borderless Paper Type Compatibility](#)

**Related tasks**

[Selecting Double-sided Printing Settings - Windows](#)

[Selecting Additional Layout and Print Options - Windows](#)

**Print Quality Options - Windows**

You can select any of the available Quality options to fine-tune the quality of your print. Some settings may be unavailable, depending on the paper type and border setting you have chosen.

**Draft**

For draft printing on plain paper.

**Draft - Vivid**

For draft printing on plain paper with good quality and print speed.

**Standard**

For everyday text and image printing.

**Standard - Vivid**

For text and graphics with good quality and print speed.

**High**

For photos and graphics with high print quality.

**More Settings**

Opens a window that lets you choose among levels of speed and quality.

**Parent topic:** [Selecting Basic Print Settings - Windows](#)

**Multi-Page Printing Options - Windows**

You can select any of the available options in the Multi-Page menu to set up your multi-page print job.

**2-Up, 4-Up, 6-Up, 8-Up, 9-Up, and 16-Up**

Prints several pages on one sheet of paper. Click the **Layout Order** button to select page layout and border options.

**2×1 Poster, 2×2 Poster, 3×3 Poster, 4×4 Poster**

Prints one image on multiple sheets of paper to create a larger poster. Click the **Settings** button to select image layout and guideline options.

**Parent topic:** [Selecting Basic Print Settings - Windows](#)

## Selecting Double-sided Printing Settings - Windows

You can print on both sides of the paper by selecting one of the **2-Sided Printing** options on the Main tab.

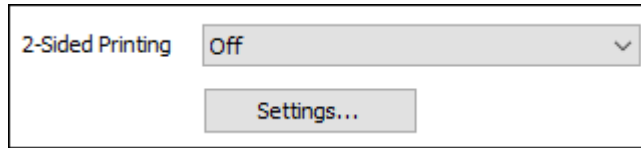

**Note:** You will need to print one side and flip the paper over manually to print the other side.

**Note:** Some options may be pre-selected or unavailable, depending on other settings you have chosen or if you are accessing the product over a network.

1. Select one of the following options for **2-Sided Printing**:
  - **Manual (Long-edge binding)** to print your double-sided print job by printing one side and prompting you to flip the paper over on the long edge to print the other side.
  - **Manual (Short-edge binding)** to print your double-sided print job by printing one side and prompting you to flip the paper over on the short edge to print the other side.
2. Click the **Settings** button.

You see a window like this:

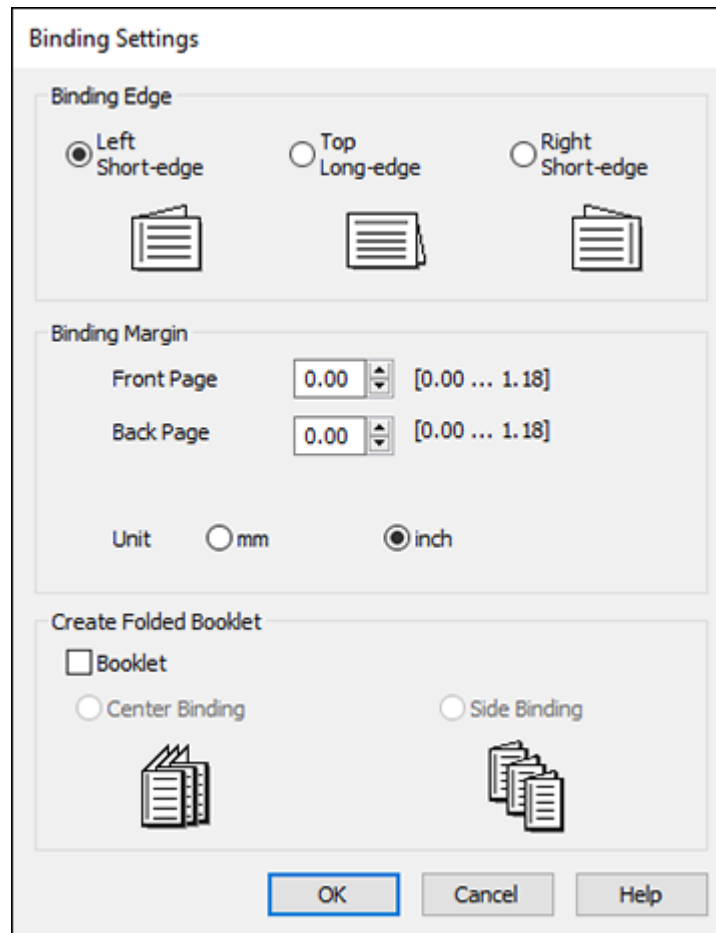

3. Select the double-sided printing options you want to use.
4. Click **OK** to return to the Main tab.
5. Print a test copy of your double-sided document to test the selected settings.
6. Follow any instructions displayed on the screen during printing.

**Note:** The surface of the paper may smear during double-sided printing. Make sure the ink has dried before reloading the paper.

[Double-sided Printing Options - Windows](#)

**Parent topic:** [Printing with Windows](#)

**Related tasks**

[Selecting Basic Print Settings - Windows](#)

## **Double-sided Printing Options - Windows**

You can select any of the available options on the Binding Settings window to set up your double-sided print job.

### **Binding Edge Options**

Select a setting that orients double-sided print binding in the desired direction.

### **Binding Margin Options**

Select options that define a wider margin to allow for binding.

### **Booklet**

Select the **Booklet** checkbox to print double-sided pages as a booklet.

### **Create Folded Booklet Options**

Select the **Booklet** checkbox and a binding option to print double-sided pages as a booklet.

**Parent topic:** [Selecting Double-sided Printing Settings - Windows](#)

## Selecting Additional Layout and Print Options - Windows

You can select a variety of additional layout and printing options for your document or photo on the **More Options** tab.

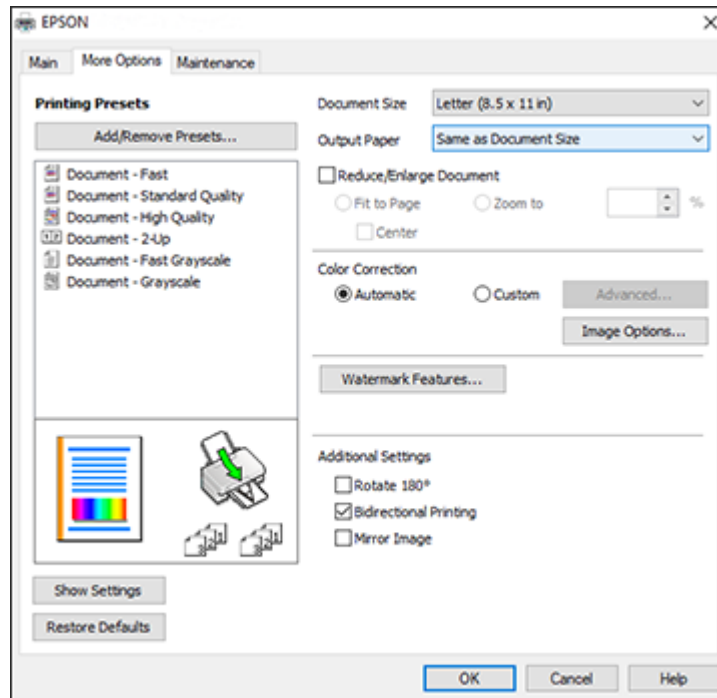

1. To change the size of your printed document or photo, select the **Reduce/Enlarge Document** checkbox and select one of these sizing options:
  - Select the **Fit to Page** option to size your image to fit the paper you loaded. Select the size of your document or photo as the Document Size setting, and the size of your paper as the Output Paper setting. If you want to center your image on the paper, select the **Center** option.
  - Select the **Zoom to** option to reduce or enlarge your document or photo by a specific percentage. Select the percentage in the % menu.
2. Select one of the following Color Correction options:
  - Select **Automatic** to automatically adjust the sharpness, brightness, contrast, and color saturation for your image.



- Select **Custom** and click the **Advanced** button to manually adjust the color correction settings or turn off color management in your printer software.
  - Select **Image Options** to access additional settings for improving printed images.
3. To add the following features, click the **Watermark Features** button:

- **Anti-Copy Pattern**: adds a watermark that only appears when your printout is copied

**Note:** This setting is not available for all types of printing. Click the **Add/Delete** button to create your own pattern, and click the **Settings** button to customize the pattern.

- **Watermark**: adds a visible watermark to your printout

**Note:** Click the **Add/Delete** button to create your own watermark, and click the **Settings** button to customize the watermark.

- **Header/Footer**: adds information such as the date and time to the top or bottom of your printout

**Note:** Click the **Settings** button to customize the text and location of the header or footer.

4. Select any of the Additional Settings options to customize your print.

[Custom Color Correction Options - Windows](#)

[Image Options and Additional Settings - Windows](#)

[Header/Footer Settings - Windows](#)

**Parent topic:** [Printing with Windows](#)

**Related tasks**

[Selecting Basic Print Settings - Windows](#)

## Custom Color Correction Options - Windows

You can select any of the available options in the Color Correction window to customize the image colors for your print job.

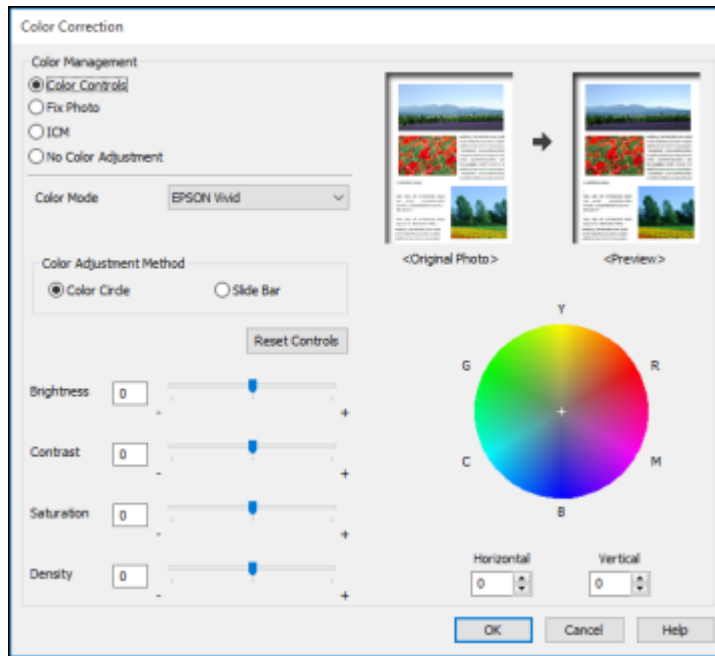

### Color Controls

Lets you select a **Color Mode** setting, individual settings for **Brightness**, **Contrast**, **Saturation**, and **Density**, and individual color tones. Depending on the selected color mode, you can also adjust the midtone density using the **Gamma** setting.

### Fix Photo

Improves the color, contrast, and sharpness of flawed photos.

**Note:** Fix Photo uses a sophisticated face recognition technology to optimize photos that include faces. For this to work, both eyes and the nose must be visible in the subject's face. If your photo includes a face with an intentional color cast, such as a statue, you may want to turn off **Fix Photo** to retain the special color effects.

**No Color Adjustment**

Turns off color management in your printer software so you can manage color using only your application software.

**Parent topic:** [Selecting Additional Layout and Print Options - Windows](#)

**Image Options and Additional Settings - Windows**

You can select any of the Image Options and Additional Settings to customize your print. Some options may be pre-selected or unavailable, depending on other settings you have chosen.

**Image Options****Emphasize Text**

Adjusts the weight of printed text to increase readability.

**Emphasize Thin Lines**

Adjusts the weight of printed lines to increase visibility.

**Edge Smoothing**

Smooths jagged edges in low-resolution images such as screen captures or images from the Web.

**Fix Red-Eye**

Reduces or removes red-eye in photos.

**Print Text in Black**

Prints colored text in black.

**For Color Text**

Prints colored text on a background pattern or underlined.

**For Color Graphs and Images**

Prints colored graphics and images with overlay patterns.

**For Color Text, Graphs, and Images**

Prints colored text, graphics, and images with overlay patterns.

**Enhancement Options**

Specifies Color Universal Print enhancement settings for text, graphics, and images.

**Additional Settings Options****Rotate 180°**

Prints the image rotated 180° from its original orientation.

**Bidirectional Printing**

Prints in both directions (right-to-left and left-to-right), speeding up printing, but may reduce print quality.

### Mirror Image

Flips the printed image left to right.

**Parent topic:** [Selecting Additional Layout and Print Options - Windows](#)

### Header/Footer Settings - Windows

You can select any of the Header/Footer Settings options to add headers or footers when you print. The items are available to print at the top or bottom of your pages, in either the left, right, or center of the page.

**Note:** These settings are not saved with your document.

Header/Footer Settings

|             |               |              |
|-------------|---------------|--------------|
| Top Left    | Top Center    | Top Right    |
| User Name   | None          | Date/Time    |
| Bottom Left | Bottom Center | Bottom Right |
| None        | None          | None         |

Starting number: 1

Start printing on page: 1

Text:

Color: Black

Font: Arial

Size: 11 pt [6 ... 72]

Style: Bold, Italic

Reset Defaults OK Cancel Help

You can select to print the following information:

- User Name
- Computer Name
- Date
- Date/Time
- Document Name
- Collate Number
- Page Number
- Text

**Note:** The user name, computer name, date, and time come from the Windows Control Panel on your computer.

**Parent topic:** [Selecting Additional Layout and Print Options - Windows](#)

## Selecting a Printing Preset - Windows

For quick access to common groups of print settings, you can select a printing preset on the **Main** or **More Options** tab.

**Note:** You can create your own preset by clicking the **Add/Remove Presets** button.

1. Click the **Main** or **More Options** tab.

You see the available **Printing Presets** on the left:

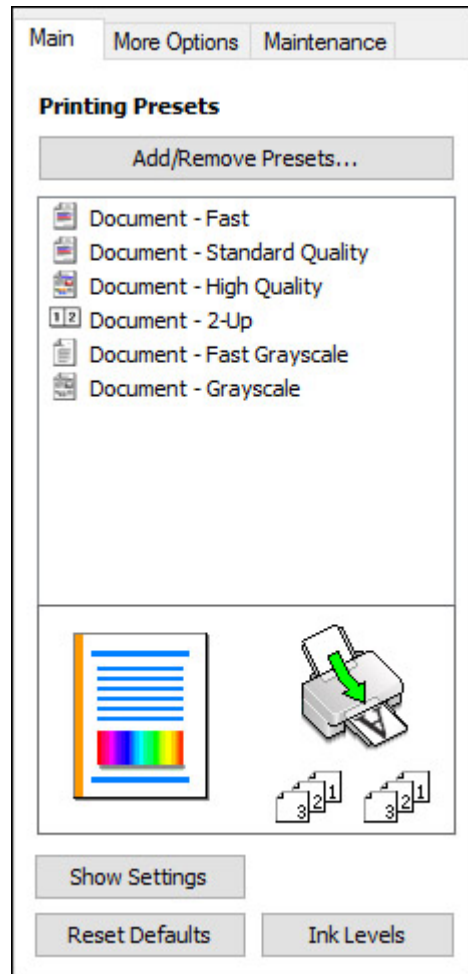



2. Place your cursor over one of the **Printing Presets** to view its list of settings.
3. Click on a preset to change its settings or delete it, or use any of the available options on the screen to control your printing presets.
4. To choose a preset for printing, select it.
5. Click **OK**.

Parent topic: [Printing with Windows](#)

## Selecting Extended Settings - Windows

You can select additional settings that apply to all the print jobs you send to your product.

1. Access the Windows Desktop and right-click the  icon for your product in the right side of the Windows taskbar, or click the up arrow and right-click .
2. Select **Printer Settings**.
3. Click the **Maintenance** tab.

You see the maintenance options:

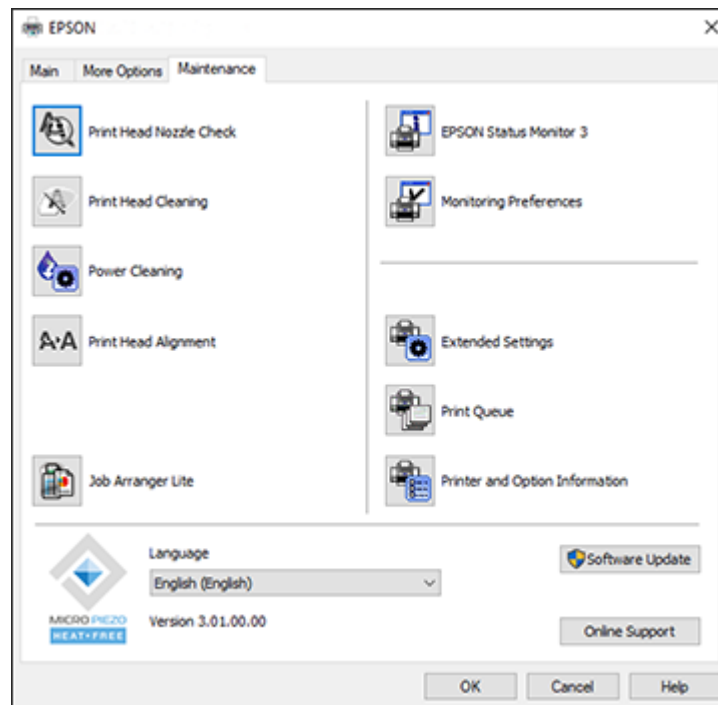

4. Click the **Extended Settings** button.

You see this window:

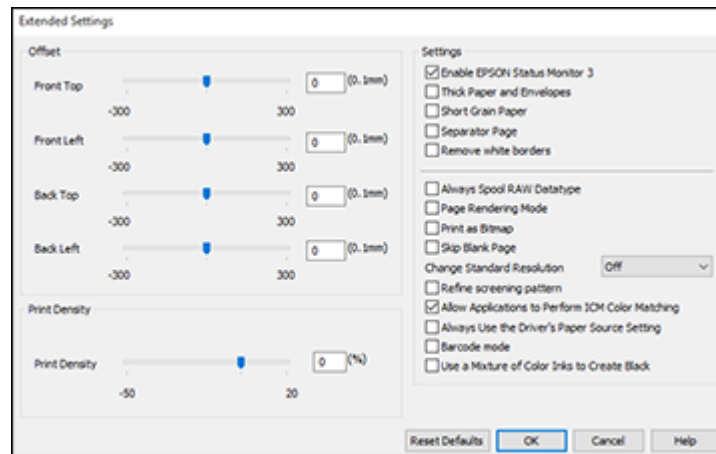

5. Select any of the extended settings to customize your print.
6. Click **OK** to close the Extended Settings window.
7. Click **OK** to close the printer software window.

[Extended Settings - Windows](#)

**Parent topic:** [Printing with Windows](#)

### **Extended Settings - Windows**

You can select these settings on the Extended Settings window.

#### **Enable EPSON Status Monitor 3**

Enables product monitoring for ink and paper supplies and other issues.

#### **Thick Paper and Envelopes**

Prevents ink from smearing when you print on envelopes or other thick paper.

#### **Short Grain Paper**

Prevents ink from smearing when you print on envelopes or other thick paper, and the **Thick Paper** setting does not help.

#### **Separator Page**

Before each document, prints a separator page containing the title, user, date, and time.



**Remove white borders**

Removes white margins that may appear when you print borderless photos.

**Always Spool RAW Datatype**

Increases print speed and may solve other printing problems.

**Page Rendering Mode**

Increases print speed when printing is extremely slow or the print head stops during printing.

**Print as Bitmap**

Increases print speed when printing is extremely slow or the print head stops during printing, and other settings do not help.

**Skip Blank Page**

Ensures that your product does not print pages that contain no text or images.

**Change Standard Resolution**

Reduces the resolution of print data to correct printing problems.

**Refine screening pattern**

Prints graphics with a finer screening pattern.

**Allow Applications to Perform ICM Color Matching**

Allows applications to perform ICM color matching.

**Always Use the Driver's Paper Source Setting**

Prints using the paper source setting in the printer driver, rather than the setting in your application.

**Barcode mode**

Reduces bleeding when printing barcodes on plain paper, letterhead paper, recycled paper, preprinted paper, envelopes, and thick paper.

**Use a Mixture of Color Inks to Create Black**

Mixes color inks to create composite black when printing at standard quality on plain paper or envelopes.

Parent topic: [Selecting Extended Settings - Windows](#)

## Printing Your Document or Photo - Windows

Once you have selected your print settings, you are ready to save your settings and print.

1. Click **OK** to save your settings.

You see your application's Print window, such as this one:

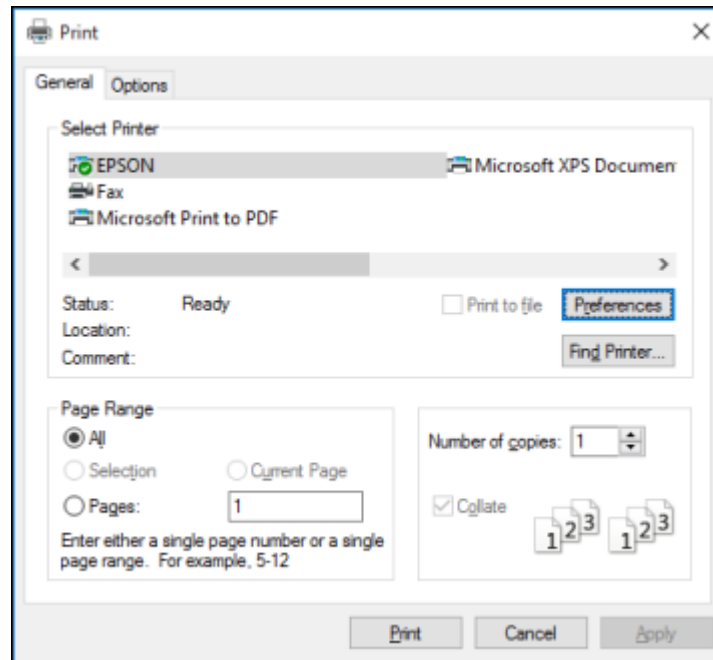



2. Click **OK** or **Print** to start printing.

**Parent topic:** [Printing with Windows](#)

**Related tasks**

[Selecting Basic Print Settings - Windows](#)

## Checking Print Status - Windows

During printing, you can see the progress of your print job by accessing the Windows Desktop and double-clicking the  icon for your product in the right side of the Windows taskbar, or clicking the up arrow and double-clicking . Click **Print Queue**.

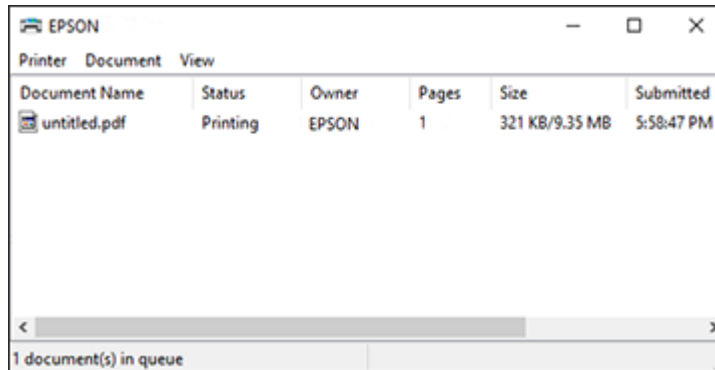

You can control printing using the options on the screen.



- To cancel printing, right-click on any print job and click **Cancel**.
- To pause printing, right-click on any print job and click **Pause**.
- To restart printing, right-click on any paused print job and click **Restart**.

Parent topic: [Printing with Windows](#)

## Locking Printer Settings - Windows

Windows administrators can lock access to some printer settings to prevent unauthorized changes.

1. Do one of the following:

- **Windows 10:** Click  and select  (Settings) > **Devices** > **Printers & scanners**. Select your product name and select **Manage** > **Printer properties**.
- **Windows 8.x:** Navigate to the **Apps** screen and select **Control Panel** > **Hardware and Sound** > **Devices and Printers**. Right-click your product and select **Printer properties**.
- **Windows 7:** Click  and select **Devices and Printers**. Right-click your product and select **Printer properties**.

- **Windows Vista:** Click  and select **Control Panel**. Click **Printer** under **Hardware and Sound**, then right-click your product and select **Properties**.
2. Click the **Optional Settings** tab.

**Note:** You can prevent access to the **Optional Settings** tab by changing the user or group permissions in the **Security** tab.

3. Click **Driver Settings**.

You see this window:

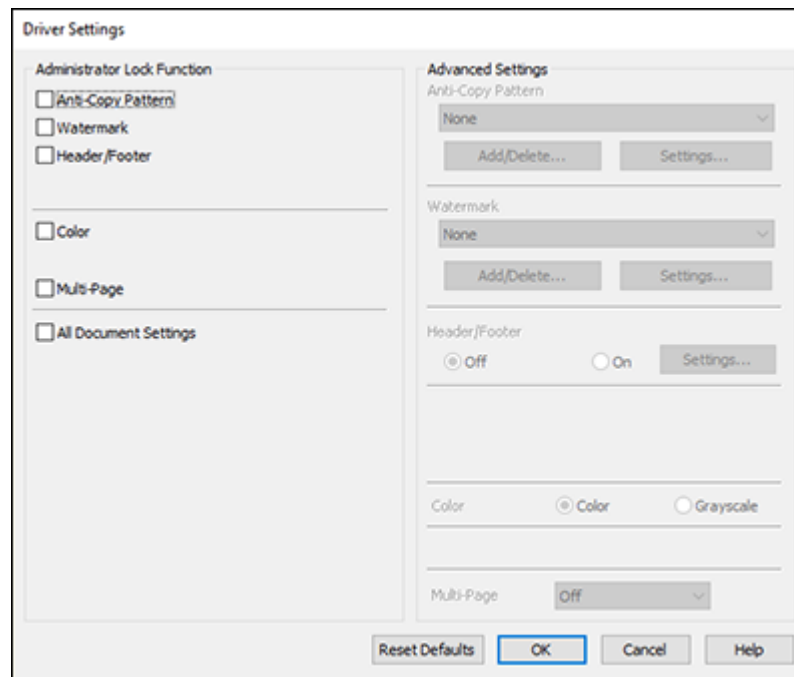

4. Select the checkbox for each setting you want to lock. To lock all print settings, select **All Document Settings**.
5. Under **Advanced Settings**, select the setting option you want to use for each locked setting.
6. Click **OK**.

## Locked Setting Options

Parent topic: [Printing with Windows](#)

### Locked Setting Options



Select the options you want to use for any locked print settings.

| Setting                  | Options                 | Description  |
|--------------------------|-------------------------|--|
| <b>Anti-Copy Pattern</b> | Various data items      | Lets you select the data to use for the pattern or prohibit anti-copy patterns             |
|                          | <b>Add/Delete</b>       | Lets you add or delete a customized anti-copy pattern                                      |
|                          | <b>Settings</b>         | Lets you select the arrangement, size, and other settings for the custom anti-copy pattern |
| <b>Watermark</b>         | Various text watermarks | Lets you select the text for the watermark or prohibit watermarks                          |
|                          | <b>Add/Delete</b>       | Lets you add or delete a customized text or image-based watermark                          |
|                          | <b>Settings</b>         | Lets you select the size, position, color and other watermark settings                     |
| <b>Header/Footer</b>     | <b>Off</b>              | Prohibits headers or footers   |
|                          | <b>On</b>               | Allows headers and footers   |
|                          | <b>Settings</b>         | Lets you select the text and position for printing headers and footers                     |
| <b>Color</b>             | <b>Color</b>            | Allows color printing  |
|                          | <b>Grayscale</b>        | Allows printing in black or shades of gray only  |
| <b>Multi-Page</b>        | <b>Off</b>              | Prohibits multi-page settings  |
|                          | <b>2-Up</b>             | Allows printing of 2 pages on one sheet of paper   |
|                          | <b>4-Up</b>             | Allows printing of 4 pages on one sheet of paper   |
|                          | <b>6-Up</b>             | Allows printing of 6 pages on one sheet of paper   |
|                          | <b>8-Up</b>             | Allows printing of 8 pages on one sheet of paper   |
|                          | <b>9-Up</b>             | Allows printing of 9 pages on one sheet of paper   |
|                          | <b>16-Up</b>            | Allows printing of 16 pages on one sheet of paper  |

Parent topic: [Locking Printer Settings - Windows](#)

## Selecting Default Print Settings - Windows

When you change your print settings in a program, the changes apply only while you are printing in that program session. If you want to change the print settings you use in all your Windows programs, you can select new default print settings.

1. Access the Windows Desktop and right-click the  icon for your product in the right side of the Windows taskbar, or click the up arrow and right-click .
2. Select **Printer Settings**.

You see the printer settings window:

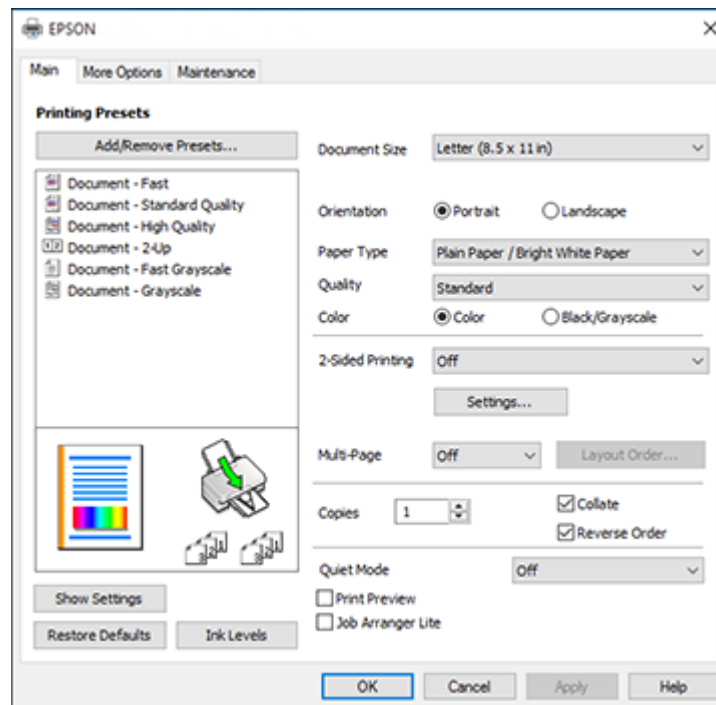

3. Select the print settings you want to use as defaults in all your Windows programs.
4. Click **OK**.

These settings are now the defaults selected for printing. You can still change them as needed for printing in any program session.

[Changing the Language of the Printer Software Screens](#)



**Parent topic:** [Printing with Windows](#)

**Related tasks**

[Selecting Basic Print Settings - Windows](#)

### **Changing the Language of the Printer Software Screens**

You can change the language used on the Windows printer software screens.

1. Access the Windows Desktop and right-click the  icon for your product in the right side of the Windows taskbar, or click the up arrow and right-click .
2. Select **Printer Settings**.  
You see the printer settings window.
3. Click the **Maintenance** tab.

You see the maintenance options:

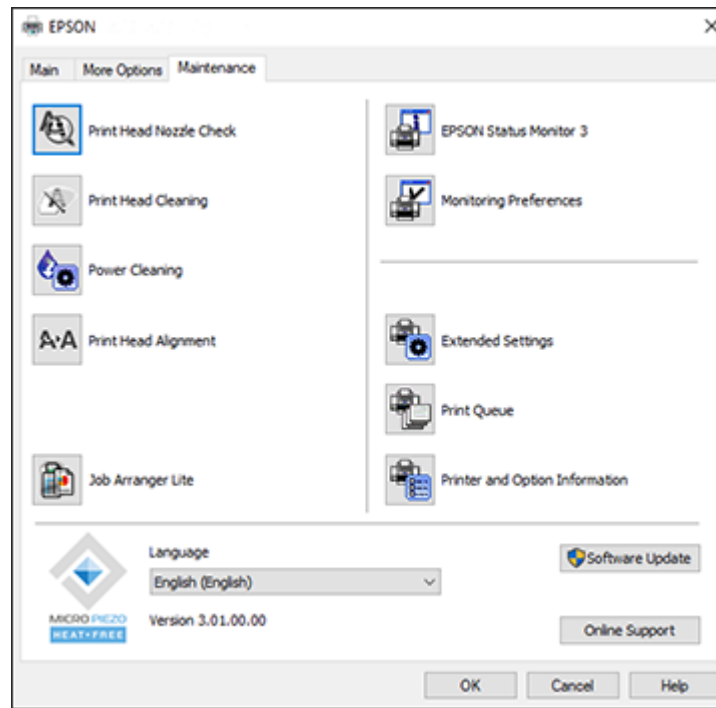



4. Select the language you want to use as the **Language** setting.
5. Click **OK** to close the printer software window.

The printer software screens appear in the language you selected the next time you access them.

**Parent topic:** [Selecting Default Print Settings - Windows](#)

## Changing Automatic Update Options

Your printer software for Windows automatically checks for updates to the product software. You can change how often the software checks for updates or disable this feature.

1. Access the Windows Desktop and right-click the  icon for your product in the right side of the Windows taskbar, or click the up arrow and right-click .
2. Select **Software Update Settings**.



You see this window:

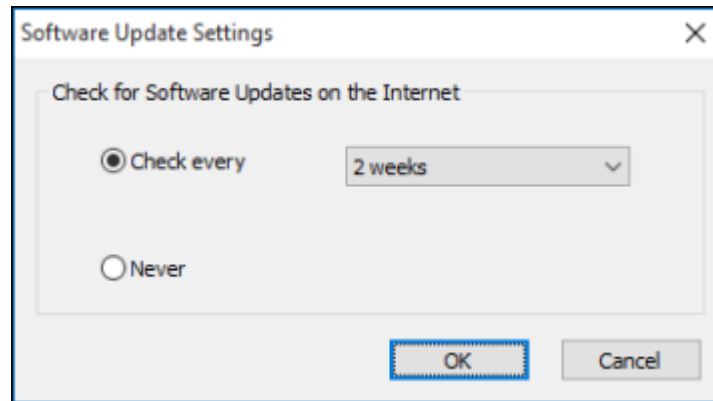

3. Do one of the following:
  - To change how often the software checks for updates, select a setting in the **Check every** menu.
  - To disable the automatic update feature, select the **Never** option.
4. Click **OK** to exit.

**Note:** If you choose to disable the automatic update feature, you can check for updates manually.

**Parent topic:** [Printing with Windows](#)

**Related tasks**

[Checking for Software Updates](#)

## Printing with the Built-in Epson Driver - Windows 10 S

You can print with the built-in Epson printer driver using any printing program on Windows 10 S, as described in these sections.

**Note:** The built-in Epson driver in Windows 10 S does not include all the available print settings for your product.

[Selecting Print Settings - Windows 10 S](#)

**Parent topic:** [Printing from a Computer](#)

## Selecting Print Settings - Windows 10 S

Select the settings for your print job in your Windows 10 S application.

1. Open a photo or document for printing.
2. Select the print command in your application.

**Note:** You may need to select a print icon on your screen, the **Print** option in the **File** menu, or another command. See your application's help utility for details.

3. If necessary, select your product name as the printer you want to use.

**Note:** You may also need to select **Properties** or **Preferences** to view your print settings.

You see a window like this:

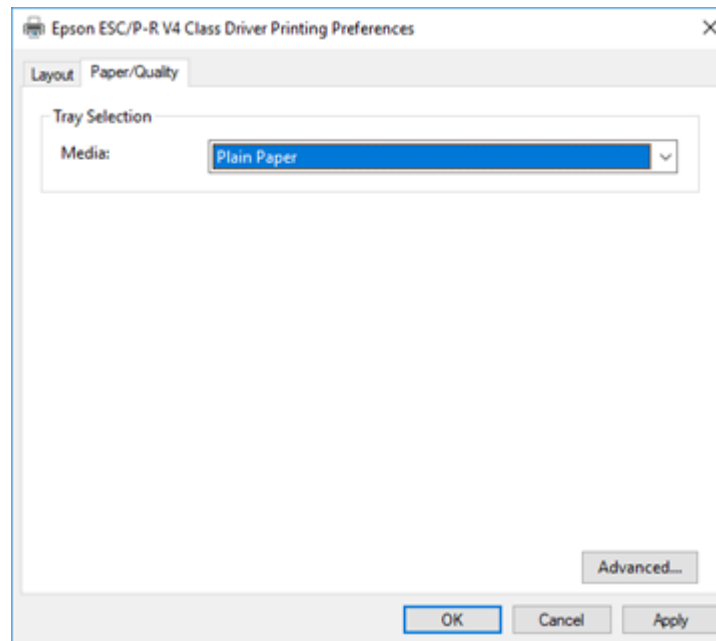

4. Select the type of paper you loaded as the **Media** setting.

**Note:** The setting may not exactly match the name of your paper. Check the paper type settings list for details.

5. Click the **Advanced** button.

You see a window like this:

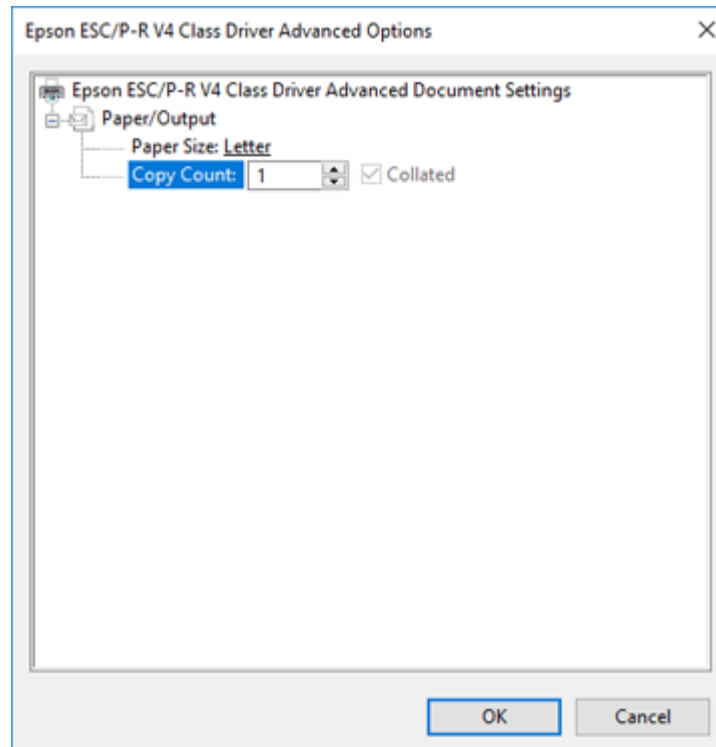

6. Select the size of the paper you loaded as the **Paper Size** setting.
7. To print multiple copies, select or enter the number as the **Copy Count** setting.
8. To print multiple copies of multi-page documents in sets, select the **Collated** checkbox.
9. Click **OK**.

You return to the printing preferences window.

10. Select the **Layout** tab.

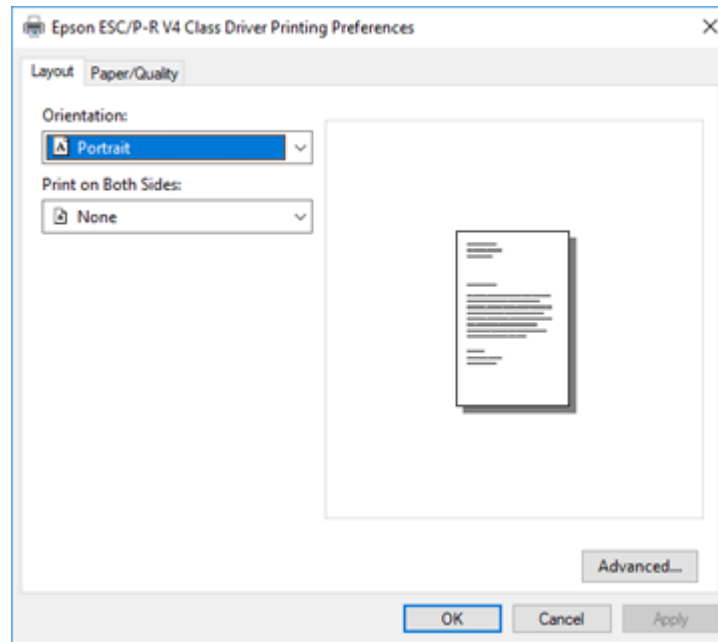

11. Select the orientation of your document as the **Orientation** setting.
12. Click **OK** to save your settings.  
You see your application's **Print** window.
13. Click **OK** or **Print** to start printing.

**Parent topic:** [Printing with the Built-in Epson Driver - Windows 10 S](#)

#### **Related references**

[Paper or Media Type Settings](#)

## **Printing on a Mac**

You can print with your product using any Mac printing program, as described in these sections.

**Note:** If you have an Internet connection, it is a good idea to check for updates to your product software on Epson's support website or using Epson Software Updater.

- [Selecting Basic Print Settings - Mac](#)
  - [Selecting Page Setup Settings - Mac](#)
  - [Selecting Print Layout Options - Mac](#)
  - [Managing Color - Mac](#)
  - [Selecting Printing Preferences - Mac](#)
  - [Printing Your Document or Photo - Mac](#)
- Parent topic:** [Printing from a Computer](#)

## Selecting Basic Print Settings - Mac

Select the basic settings for the document or photo you want to print.

1. Open a photo or document for printing.
2. Select the print command in your application.

**Note:** You may need to select a print icon on your screen, the **Print** option in the File menu, or another command. See your application's help utility for details.

3. Select your product as the **Printer** setting.

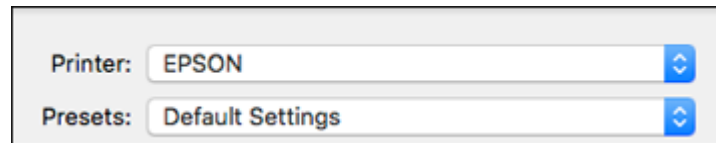

4. If necessary, click the **Show Details** button to expand the print window.

You see the expanded printer settings window for your product:

Printer: EPSON

Presets: Default Settings

Copies: 1

Pages:  All  
 From: 1 to: 1

Paper Size: US Letter 8.50 by 11.00 inches

Orientation:  Portrait  Landscape

Preview

Auto Rotate

Scale: 46%

Scale to Fit:  Print Entire Image  
 Fill Entire Paper

Copies per page: 1

PDF Cancel Print

**Note:** The print window may look different, depending on the Mac OS version and the application you are using.

5. Select the **Copies** and **Pages** settings as necessary.

**Note:** If you do not see these settings in the print window, check for them in your application before printing.

6. Select the page setup options: **Paper Size** and **Orientation**.

**Note:** If you do not see these settings in the print window, check for them in your application before printing. They may be accessible by selecting **Page Setup** from the File menu.

**Note:** Paper sizes may include additional options such as **Borderless**.

7. Select any application-specific settings that appear on the screen, such as those shown in the image above for the Preview application.
8. Select **Print Settings** or **Printer Features** from the pop-up menu.

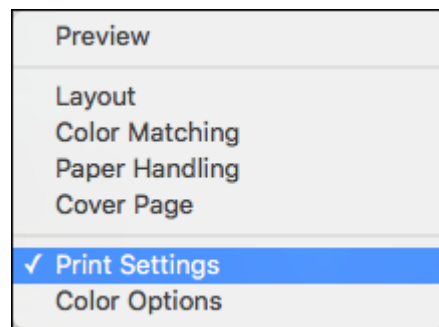

You see these settings:

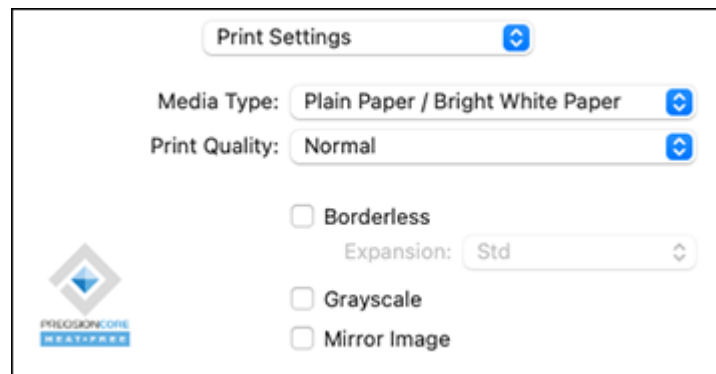

**Note:** The available print settings and appearance of the print window may be different than those covered here, depending on the Mac OS version and the application you are using.

9. Select the type of paper you loaded as the **Media Type** setting.

**Note:** The setting may not exactly match the name of your paper. Check the paper type settings list for details.

10. Select the **Print Quality** setting you want to use.
11. Select the **Borderless** checkbox if you want to print a borderless photo. If the option is grayed out, change the **Media Type** setting to a paper type that supports borderless printing.
12. Select any of the available print options.

[Print Quality Options - Mac](#)

[Print Options - Mac](#)

**Parent topic:** [Printing on a Mac](#)

#### **Related references**

[Paper or Media Type Settings](#)

#### **Related tasks**

[Selecting Page Setup Settings - Mac](#)

### **Print Quality Options - Mac**

You can select any of the available Print Quality options to fine-tune the quality of your print. Some settings may be unavailable, depending on the paper type setting you have chosen.

#### **Draft**

For draft printing on plain paper.

#### **Draft-Vivid**

For draft printing on plain paper with good quality and print speed.

#### **Normal**

For everyday text and image printing.

#### **Normal - Vivid**

For everyday text and image printing with good quality and print speed.

#### **Fine**

For text and graphics with good quality and print speed.



**Quality**

For text and graphics with increased quality and print speed.

**Parent topic:** [Selecting Basic Print Settings - Mac](#)

**Print Options - Mac**

You can select any of the print options to customize your print. Some options may be unavailable, depending on other settings you have chosen.

**Expansion**

If you selected a borderless paper size setting, this option adjusts the image expansion settings to control printing at the edges of borderless prints.

**Grayscale**

Prints text and graphics in black or shades of gray.

**Mirror Image**

Lets you flip the printed image horizontally.

**Parent topic:** [Selecting Basic Print Settings - Mac](#)

**Selecting Page Setup Settings - Mac**

Depending on your application, you may be able to select the paper size and orientation settings from the print window.

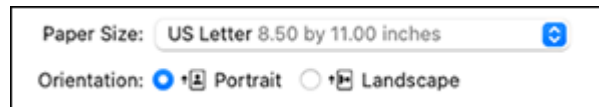

**Note:** If you do not see these settings in the print window, check for them in your application before printing. They may be accessible by selecting **Page Setup** from the File menu.

1. Select the size of the paper you loaded as the **Paper Size** setting. If you are printing a borderless photo, select the **Borderless** checkbox or a paper size with a **Borderless** option. You can also select a custom setting to create a custom paper size, but the Quality setting will be limited to **Normal**.

**Note:** You must select a compatible borderless paper type and size to print without borders. Check the borderless paper compatibility list for details.

2. Select the orientation of your document or photo as shown in the print window.

**Note:** If you are printing an envelope, select the **Landscape** setting.

**Note:** You can reduce or enlarge the size of the printed image by selecting **Paper Handling** from the pop-up menu and selecting a scaling option.

**Parent topic:** [Printing on a Mac](#)

#### **Related tasks**

[Selecting Basic Print Settings - Mac](#)

## **Selecting Print Layout Options - Mac**

You can select a variety of layout options for your document or photo by selecting **Layout** from the pop-up menu on the print window.

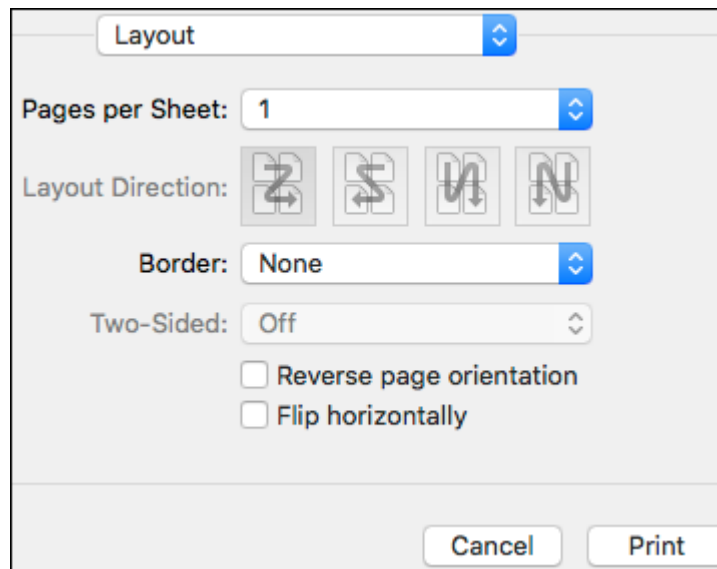

- To print multiple pages on one sheet of paper, select the number of pages in the **Pages per Sheet** pop-up menu. To arrange the print order of the pages, select a **Layout Direction** setting.
- To print borders around each page on the sheet, select a line setting from the **Border** pop-up menu.

- To print on both sides of each page, select a setting from the **Two-Sided** pop-up menu.
- To invert or flip the printed image, select the **Reverse page orientation** or **Flip horizontally** settings.

**Parent topic:** [Printing on a Mac](#)

## Managing Color - Mac

You can adjust the Color Matching and Color Options settings to fine-tune the colors in your printout or turn off color management in your printer software.

1. Select **Color Matching** from the pop-up menu in the print window.

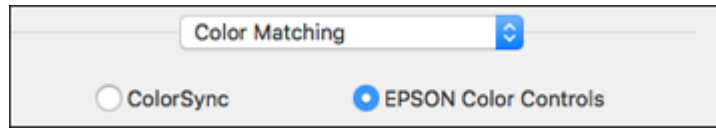

2. Select one of the available options.
3. Select **Color Options** from the pop-up menu in the print window.

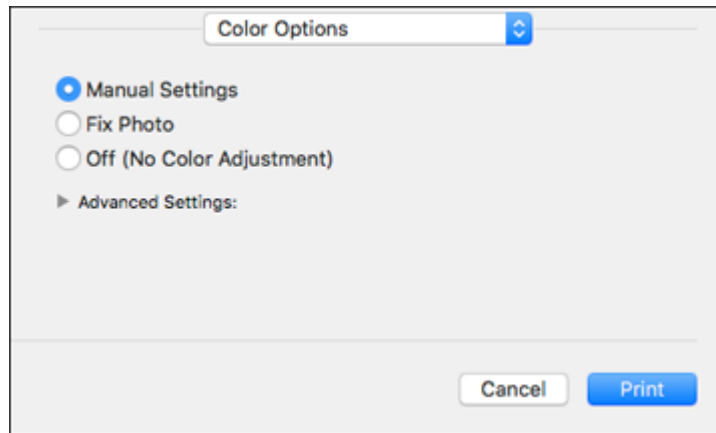

**Note:** The available settings on the Color Options menu depend on the option you selected on the Color Matching menu.

4. Select one of the available options.

[Color Matching and Color Options - Mac](#)

**Parent topic:** [Printing on a Mac](#)

## **Color Matching and Color Options - Mac**

You can select these settings on the **Color Matching** and **Color Options** menus.

### **Color Matching Settings**

#### **EPSON Color Controls**

Lets you manage color using controls in your printer driver or turn off color management.

#### **ColorSync**

Prints using standard color profiles for your product and paper to help match image colors. You can customize the conversion method and filter settings on the ColorSync pop-up menu in the print window.

### **Color Options Settings**

#### **Manual Settings**

Lets you select manual color adjustments. Click the arrow next to **Advanced Settings** and select settings for **Brightness**, **Contrast**, **Saturation**, and individual color tones. You can also select a color **Mode** setting for printing photos and graphics and the **Fix Red-Eye** setting to reduce or remove red-eye in photos. Depending on the selected color mode, you can also adjust the midtone density using the **Gamma** setting.

#### **Fix Photo**

Improves the color, contrast, and sharpness of flawed photos. Click the arrow next to **Advanced Settings** and select the **Fix Red-Eye** setting to reduce or remove red-eye in photos.

**Note:** Fix Photo uses a sophisticated face recognition technology to optimize photos that include faces. For this to work, both eyes and the nose must be visible in the subject's face. If your photo includes a face with an intentional color cast, such as a statue, you may want to turn off **Fix Photo** to retain the special color effects.

#### **Off (No Color Adjustment)**

Turns off color management in your printer software so you can manage color using only your application software.

**Note:** An ICC profile is required if color management is turned off.

**Parent topic:** [Managing Color - Mac](#)

## Selecting Printing Preferences - Mac

You can select printing preferences that apply to all the print jobs you send to your product.

1. In the Apple menu or the Dock, select **System Preferences**.
2. Select **Print & Fax**, **Print & Scan**, or **Printers & Scanners**, select your product, and select **Options & Supplies**.
3. Select **Driver** or **Options**.

You see a screen like this:

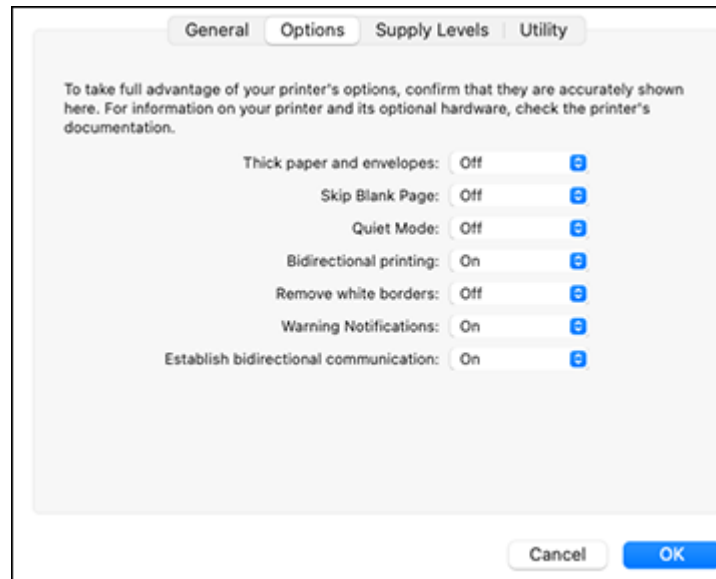

4. Select any of the available printing preferences.
5. Click **OK**.

[Printing Preferences - Mac](#)

**Parent topic:** [Printing on a Mac](#)

### Printing Preferences - Mac

You can select these settings on the **Options** or **Driver** tab.

**Thick Paper and Envelopes**

Prevents ink from smearing when you print on envelopes or other thick paper.

**Skip Blank Page**

Ensures that your product does not print pages that contain no text or images.

**Quiet Mode**

Lessens noise during printing but may decrease print speed.

**Bidirectional printing**

Prints in both directions (right-to-left and left-to-right), speeding up printing, but may reduce print quality.

**Remove white borders**

Removes white margins that may appear when you print borderless photos.

**Warning Notifications**

Lets you choose whether or not to receive warning notifications from the printer software for various operating conditions.

**Establish bidirectional communication**

Allows the product to communicate with the computer. Do not change the default setting unless you experience issues when using a shared printing pool.

Parent topic: [Selecting Printing Preferences - Mac](#)

**Printing Your Document or Photo - Mac**

Once you have selected your print settings, you are ready to print.

Click **Print** at the bottom of the print window.

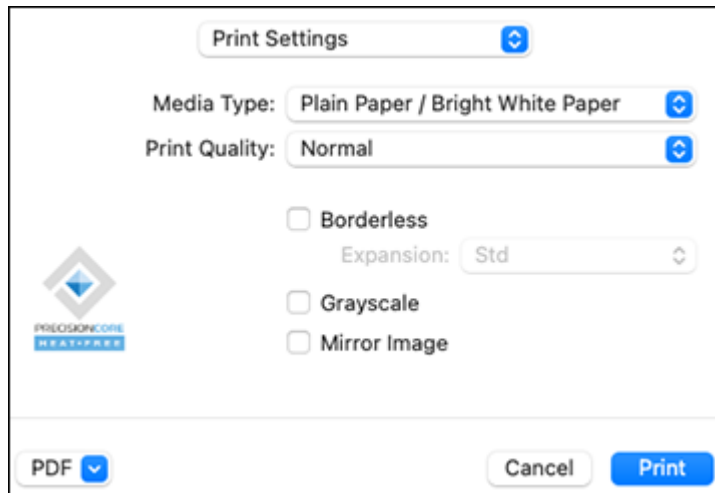

[Checking Print Status - Mac](#)

**Parent topic:** [Printing on a Mac](#)

**Related tasks**

[Selecting Basic Print Settings - Mac](#)

### **Checking Print Status - Mac**



During printing, you can view the progress of your print job, control printing, and check ink status.

1. Click the printer icon when it appears in the Dock.

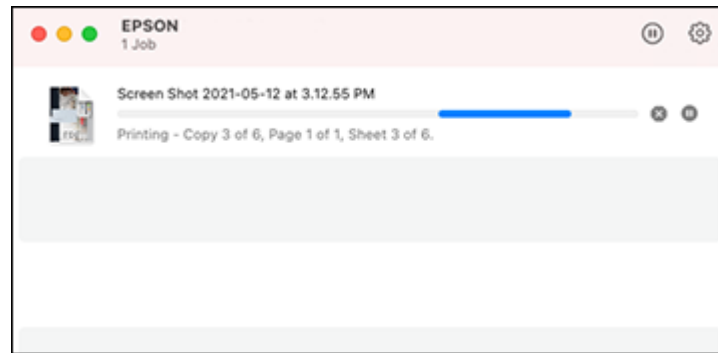
You see the print status window:



2. Select the following options as necessary for your Mac OS version:

- To cancel printing, click the print job and click  or **Delete**.
- To pause a print job, click the print job and click  or **Hold**. To resume a print job, click the paused print job and click  or **Resume**.
- To pause printing for all queued print jobs, click **Pause** or **Pause Printer**.
- To display other printer information, click **Settings** or **Supply Levels**.

**Parent topic:** [Printing Your Document or Photo - Mac](#)

## Printing from a Smartphone or Tablet

You can print from a smartphone or tablet running iOS or Android using the Epson Smart Panel app.

**Note:** Your device must be connected to the same wireless network as your Epson product, and Epson Smart Panel must be configured for use with your product.

1. Download the Epson Smart Panel app from your device's app store or from Epson's website. See the link below.
2. Open the Epson Smart Panel app and select a print menu on the home screen.
3. Follow the on-screen instructions to begin printing.

**Parent topic:** [Printing from a Computer](#)



### Related tasks

[Using the Epson Smart Panel Mobile App](#)

## Printing with Epson Photo+

You can print photos, CD/DVD labels, and more using a variety of layouts and templates with Epson Photo+. Features include image corrections and adjustments, and adding text and stamps to photos. We recommend printing on genuine Epson photo paper for the best results. Make sure you have set up your product as described on the *Start Here* sheet and installed the Epson Photo+ software. See the Epson Photo+ help utility for more information.

**Note:** If you are using your Epson product with the Windows 10 S operating system, you cannot use Epson Photo+. You also cannot download and install any Epson product software from the Epson website for use with Windows 10 S; you must obtain software only from the Windows Store.

**Parent topic:** [Printing from a Computer](#)

## Cancelling Printing Using a Product Button

If you need to cancel printing, press the  stop button.

**Parent topic:** [Printing from a Computer](#)

---

# Scanning

You can scan your originals and save them as digital files.

[Starting a Scan](#)

[Scanning a Document or Photo in Epson ScanSmart](#)

[Selecting Epson ScanSmart Settings](#)

[Scanning in Epson Scan 2](#)

## Starting a Scan

After placing your originals on your product for scanning, start scanning using one of these methods.

[Starting a Scan Using the Product Buttons](#)

[Starting a Scan Using Epson ScanSmart](#)

[Starting a Scan Using the Epson Scan 2 Icon](#)



[Starting a Scan from a Scanning Program](#)

[Starting a Scan from a Smartphone or Tablet](#)

**Parent topic:** [Scanning](#)

## Starting a Scan Using the Product Buttons

You can scan an image and save it as a PDF using your product's control panel buttons. You can change the default scan settings using the Event Manager utility on the computer.

1. Make sure you installed the product software and connected the product to your computer using a USB cable.
2. Place your original on the product for scanning.
3. Press the  B&W copy button and the  color copy button at the same time.

Your original is scanned and saved as a PDF on your computer.

[Changing Default Scan Job Settings](#)

[Setting Up a WSD Port \(Windows 7/Windows Vista\)](#)



**Parent topic:** [Starting a Scan](#)

**Related tasks**

[Scanning in Epson Scan 2](#)

## Changing Default Scan Job Settings

You can view or change the default scan job settings your product uses when you scan to your computer. You do this using the Event Manager program.

1. Do one of the following to open Event Manager:
  - **Windows 10:** Click  and select **Epson Software > Event Manager**.
  - **Windows 8.x:** Navigate to the **Apps** screen and select **Event Manager**.
  - **Windows (other versions):** Click  or **Start > All Programs** or **Programs > Epson Software > Event Manager**.
  - **Mac:** Open the **Applications** folder, click **Epson Software**, and select **Event Manager**.
2. Open the **Scanner** (Windows) or **Select Scanner** (Mac) drop-down list and select your product, if necessary.
3. Click **Make Job Settings**.
4. Open the **Edit Job Settings** drop-down list and select the scan job settings you want to view or change.
5. Change the settings as necessary.
6. Click **OK**.
7. Click **Close** to close the Event Manager window.

**Parent topic:** [Starting a Scan Using the Product Buttons](#)

## Setting Up a WSD Port (Windows 7/Windows Vista)

You can scan to a networked Windows computer using WSD (Web Services for Devices). You must first set up a WSD port on your Windows 7 or Windows Vista system (the port is set up automatically on Windows 10 and Windows 8.x).

Before you set up a WSD port, make sure you installed your product software, and connected your product and computer to the same network.

1. Turn on your product.
2. Print a network status sheet so you can identify the network name and model name for your product on the network.
3. Click  or **Start** and select **Computer**.
4. On the left side of the window, select **Network**.
5. Locate your product on the Network screen, right-click it, and select **Install**.

6. When you see the User Account Control screen, click **Continue**.

**Note:** If you see an Uninstall screen, click **Uninstall** and repeat these steps as necessary.

7. When you see the message **Your device is ready to use** in the Windows taskbar, click the message.

8. On the Driver Software Installation screen, make sure your product is listed as **Ready to use**. Then click **Close**.

9. Do one of the following:

- **Windows 7:** Click  and select **Devices and Printers**.
- **Windows Vista:** Click **Start** and select **Control Panel > Hardware and Sound > Printers**.



10. Make sure that an icon appears for your product's name on the network.

When you use WSD, select your product name to scan over the network.

**Parent topic:** [Starting a Scan Using the Product Buttons](#)

## Starting a Scan Using Epson ScanSmart

You can start the Epson ScanSmart program to scan originals and easily review and edit scanned images. After that, you can save, print, or share them.

- **Windows 10:** Click  > **Epson Software > Epson ScanSmart**.
- **Windows 8.x:** Navigate to the **Apps** screen and select **Epson ScanSmart**.
- **Windows (other versions):** Click  or **Start**, and select **All Programs** or **Programs**. Select **Epson Software > Epson ScanSmart**.
- **Mac:** Open the **Applications** folder, open the **Epson Software** folder, and select **Epson ScanSmart**.

You see a screen like this:

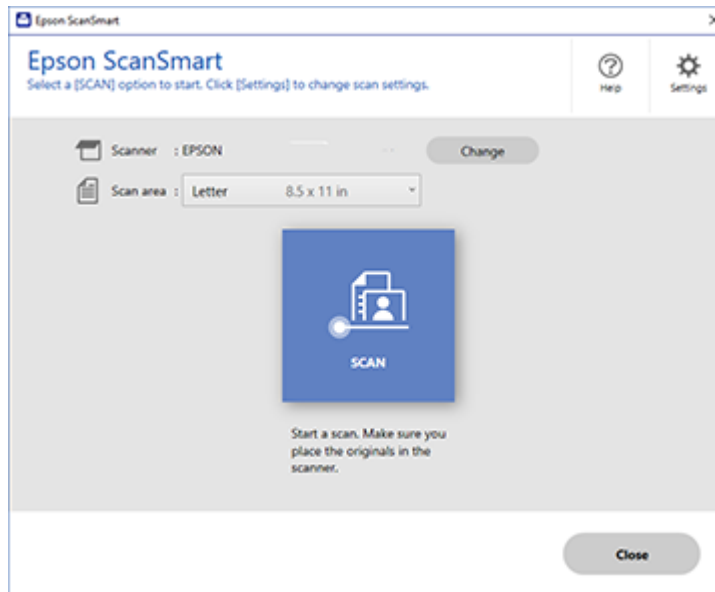



Parent topic: [Starting a Scan](#)

## Starting a Scan Using the Epson Scan 2 Icon

You can start the Epson Scan 2 program to select scan settings, scan, and save the scanned image to a file.

**Note:** If you are using your Epson product with the Windows 10 S operating system, you cannot use the software described in this section. You also cannot download and install any Epson product software from the Epson website for use with Windows 10 S; you must obtain software only from the Windows Store.

- **Windows 10:** Click  and select **EPSON > Epson Scan 2**.
- **Windows 8.x:** Navigate to the **Apps** screen and select **Epson Scan 2**.
- **Windows (other versions):** Click  or **Start**, and select **All Programs** or **Programs**. Select **EPSON > Epson Scan 2 > Epson Scan 2**.

- **Mac:** Open the **Applications** folder, open the **Epson Software** folder, and select **Epson Scan 2**. You see an Epson Scan 2 window like this:

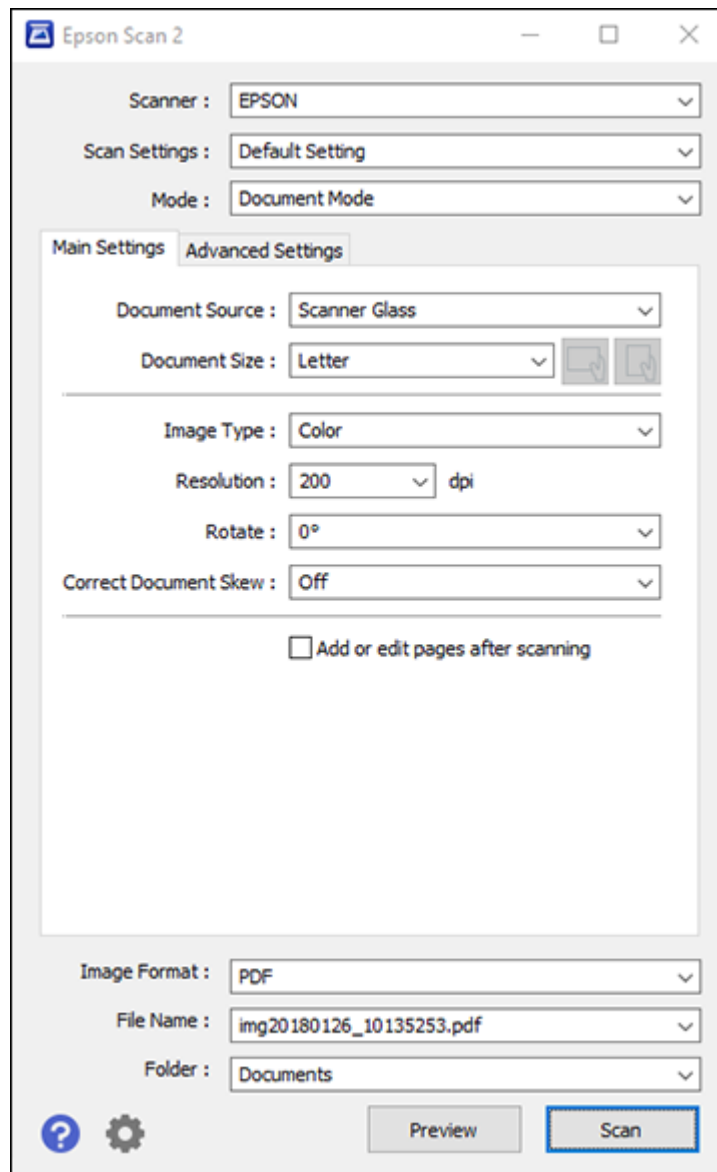

Parent topic: [Starting a Scan](#)

## Starting a Scan from a Scanning Program

You can start Epson Scan 2 from a TWAIN-compliant scanning program to select scan settings, scan, and open the scanned image in the program.

**Note:** If you are using your Epson product with the Windows 10 S operating system, you cannot use the software described in this section. You also cannot download and install any Epson product software from the Epson website for use with Windows 10 S; you must obtain software only from the Windows Store.

1. Open your scanning program and select its scanning option. (See your scanning program help for instructions.)
2. Select your product.

**Note:** In certain programs, you may need to select your product as the "source" first. If you see a **Select Source** option, choose it and select your product. With Windows, do not select a **WIA** option for your product; not all scan functions will be available.

You see an Epson Scan 2 window like this:

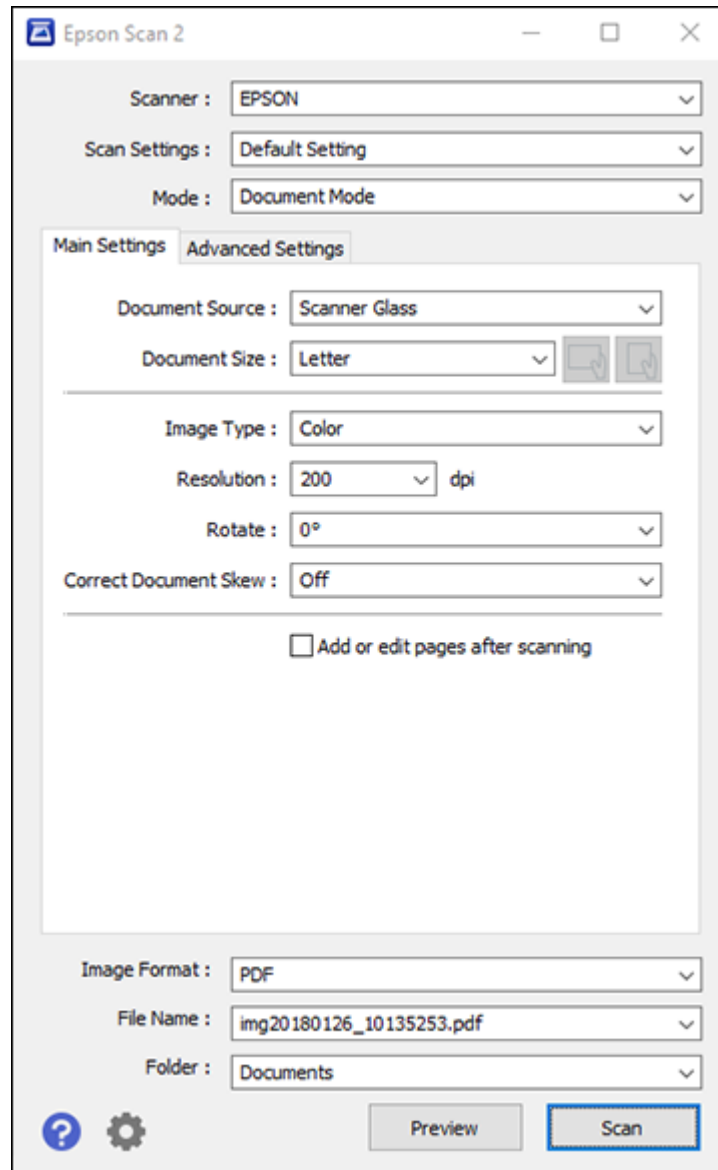



**Parent topic:** [Starting a Scan](#)

**Related tasks**

[Scanning in Epson Scan 2](#)

## Starting a Scan from a Smartphone or Tablet

You can use the Epson Smart Panel app to scan from a network scanner to an iOS or Android device over a direct Wi-Fi connection.

1. Download the Epson Smart Panel app from your device's app store or from Epson's website. See the link below.
2. Place your original on the product for scanning.
3. Open the Epson Smart Panel app and select a scan menu on the home screen.
4. Follow the on-screen instructions to scan and save your original.

**Parent topic:** [Starting a Scan](#)



**Related tasks**

[Using the Epson Smart Panel Mobile App](#)

## Scanning a Document or Photo in Epson ScanSmart

You can scan and review documents and photos in Epson ScanSmart.

**Note:** The images in this guide show Windows screens. Mac screens may be slightly different. Depending on your product model and software version, not all options may be available.

1. Place your original on the product for scanning.
2. Open Epson ScanSmart on your computer. Do one of the following:
  - **Windows 10:** Click  > **Epson Software** > **Epson ScanSmart**.
  - **Windows 8.x:** Navigate to the **Apps** screen and select **Epson ScanSmart**.
  - **Windows (other versions):** Click  or **Start**, and select **All Programs** or **Programs**. Select **Epson Software** > **Epson ScanSmart**.
  - **Mac:** Open the **Applications** folder, open the **Epson Software** folder, and select **Epson ScanSmart**.

You see a screen like this:

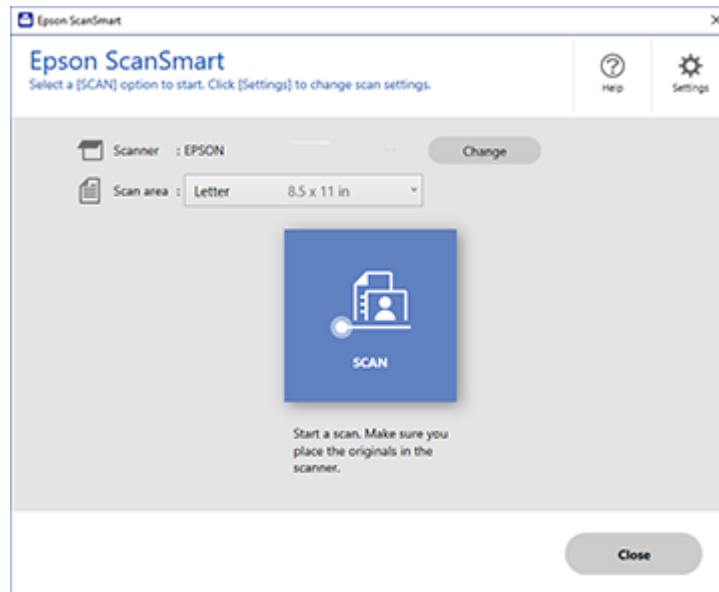

3. Select an option for the **Scan area** setting, if necessary.

**Note:** The **Scan area** setting limits the scan area to a selected size starting at the placement arrow on the scanner bed. It does not scale the image to the selected size.

4. Select **SCAN**.

The original is scanned. When scanning is complete, you see a screen like this:

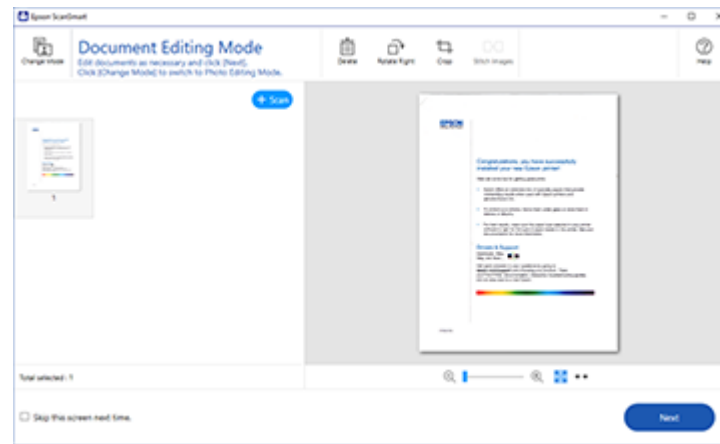

**Note:** To change between document or photo editing options, select **Change Mode**.

5. In Document Editing Mode, you can review, edit, or reorder the scanned images as follows:
  - Select **+ Scan** to scan more originals.
  - Select **Delete** to delete selected scanned images.
  - Select **Rotate Right** to rotate each scanned image.
  - Select **Crop** to crop the selected image.
  - Control-click two images, select **Stitch Images**, and follow the on-screen instructions to combine them into a single image.
6. In Photo Editing Mode, the following enhancement options are available:
  - **Auto Color Enhancement:** automatically adjusts the brightness, contrast, and saturation of your photos
  - **Restore Faded Colors:** restores the colors in faded photos automatically
  - **Remove Red Eye:** automatically removes the red-eye effect from your photos
  - **Auto Cropping:** automatically crops the scanned image edges
7. When you finish reviewing and editing the scanned images, click **Next**.

You see a screen like this:

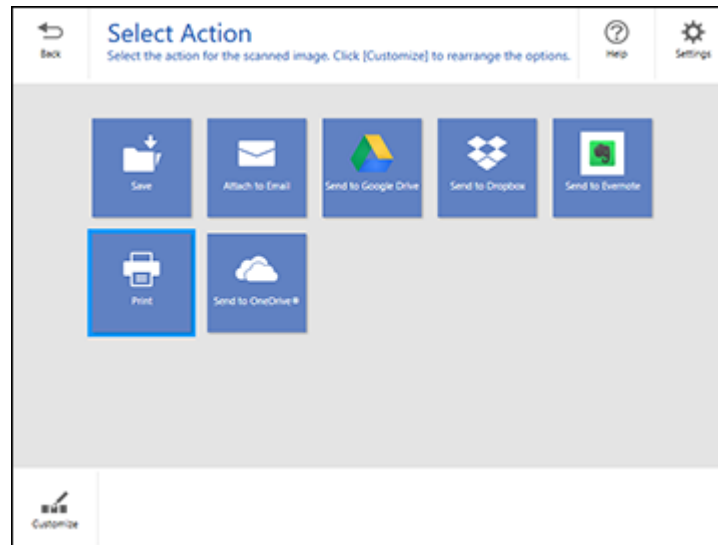

8. Select an option to save, send, or print the scanned images. See the links below.

[Saving a Scan](#)

[Attaching a Scan to Email](#)

[Sending a Scan to a Cloud Service](#)

[Printing a Scan](#)

**Parent topic:** [Scanning](#)

## **Saving a Scan**

You can save a scanned image to your computer in a variety of formats.

1. Make sure your originals are scanned and reviewed. See the link below.
2. In the **Select Action** window, click **Save**.

You see a screen like this:

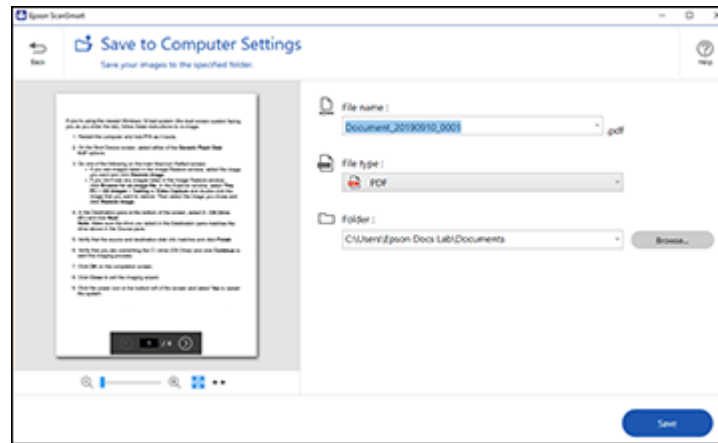

3. Change the settings as follows:
  - The document type and scan date for the file name are automatically detected. You can change them as necessary.
  - You can save the scanned image in a variety of formats. If you select Searchable PDF as the **File type** setting, you can select the OCR (Optical Character Recognition) language.
  - Select the folder on your computer in which to save the file.
4. Click **Save**.

**Parent topic:** [Scanning a Document or Photo in Epson ScanSmart](#)

## Attaching a Scan to Email

You can attach a scanned image to an email as a file attachment.

**Note:** Your email app and account settings should be configured before scanning. You must install a MAPI-type email program such as Outlook Express, Windows Live Mail, Entourage, or Mac Mail. Attach to Email only supports 32-bit MAPI-compatible mail apps. Web-based email services such as Gmail are not supported. If you see an error message, your email app may not be compatible and you will need to save the scans and manually attach the file to an email.

1. Make sure your originals are scanned and reviewed. See the link below.

2. In the **Select Action** window, click **Attach to Email**.

You see a screen like this:

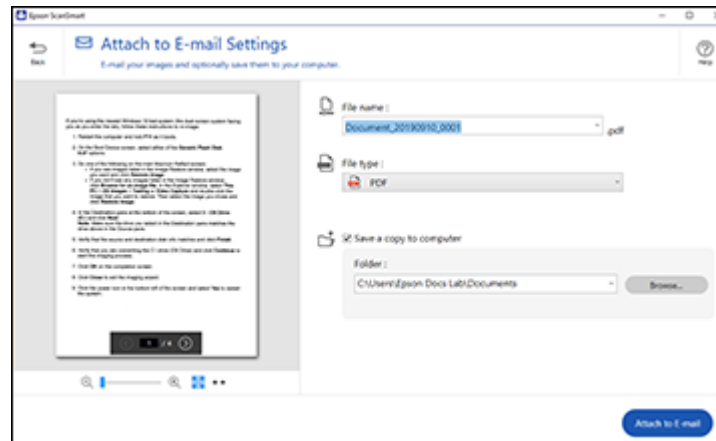

3. Change the settings as follows:
  - The document type and scan date for the file name are automatically detected. You can change them as necessary.
  - You can save the scanned image in a variety of formats. If you select Searchable PDF as the **File type** setting, you can select the OCR (Optical Character Recognition) language.
  - If you also want to save a copy of the scanned image to your computer, make sure the checkbox is selected and select the folder on your computer in which to save the file.
4. Click **Attach to E-mail**.

Your email program opens with the file attached to a new email.

**Parent topic:** [Scanning a Document or Photo in Epson ScanSmart](#)

## Sending a Scan to a Cloud Service

You can upload scanned images to a cloud service.

1. Make sure your originals are scanned and reviewed. See the link below.
2. In the **Select Action** window, click one of the cloud service send options.

You see a screen like this:

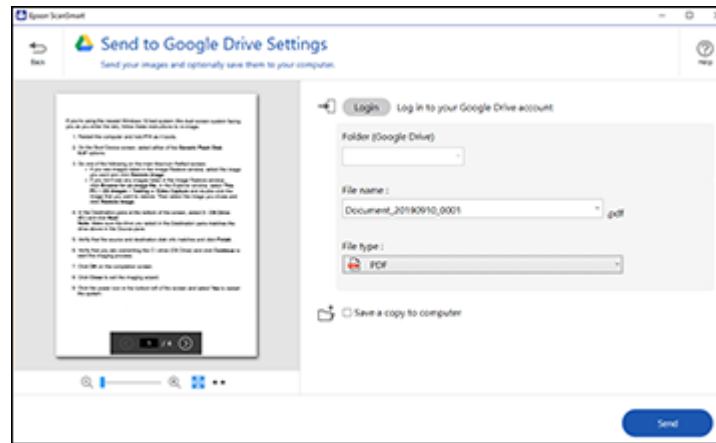

3. Log in to your account.

**Note:** You may need to allow Epson ScanSmart access to your account. The first time you log in, you may be prompted to enter an authentication code.

4. Change the settings as follows:
  - Select the folder in your account where you want to send the document.
  - The document type and scan date for the file name are automatically detected. You can change them as necessary.
  - You can save the scanned image in a variety of formats. If you select Searchable PDF as the **File type** setting, you can select the OCR (Optical Character Recognition) language.
  - If you also want to save a copy of the scanned image to your computer, click the checkbox.
5. Click **Send**.

**Parent topic:** [Scanning a Document or Photo in Epson ScanSmart](#)

## Printing a Scan

You can print your scanned image and save the scanned file to your computer.

**Note:** Printing scanned images is available only with Epson printers. If you do not have an Epson printer, save the file and print it from an application that can open the file.

1. Make sure your originals are scanned and reviewed. See the link below.
2. In the **Select Action** window, click **Print**.

You see a screen like this:

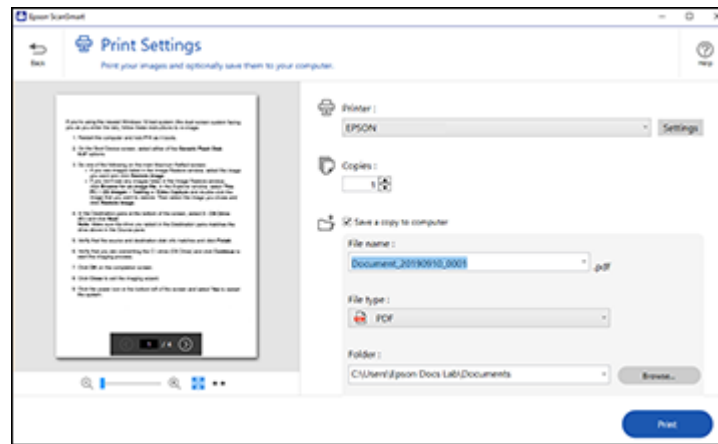

3. Change the settings as follows:
  - Select the Epson printer and change the print settings, if necessary.
  - Select the number of copies you want to print.
  - If you also want to save a copy of the scanned image to your computer, click the checkbox.
  - The document type and scan date for the file name are automatically detected. You can change them as necessary.
  - You can save the scanned image in a variety of formats. If you select Searchable PDF as the **File type** setting, you can select the OCR (Optical Character Recognition) language.
  - Select the folder on your computer in which to save the file.
4. Click **Print**.

**Parent topic:** [Scanning a Document or Photo in Epson ScanSmart](#)



## Selecting Epson ScanSmart Settings

After starting Epson ScanSmart, you can change various scanning settings.

[Changing the Epson Product](#)

[Changing the Scan Settings](#)

[Changing the File Name Settings](#)

[Changing the Save Settings](#)

[Save Settings](#)

[Customizing Action Icons](#)

**Parent topic:** [Scanning](#)

## Changing the Epson Product

If you are using more than one Epson product with Epson ScanSmart, you can change the product that you are using with your computer.

**Note:** A product connected to your computer via USB takes priority over a product with a Wi-Fi connection.

1. On the main screen, click **Change**.

You see a screen like this:

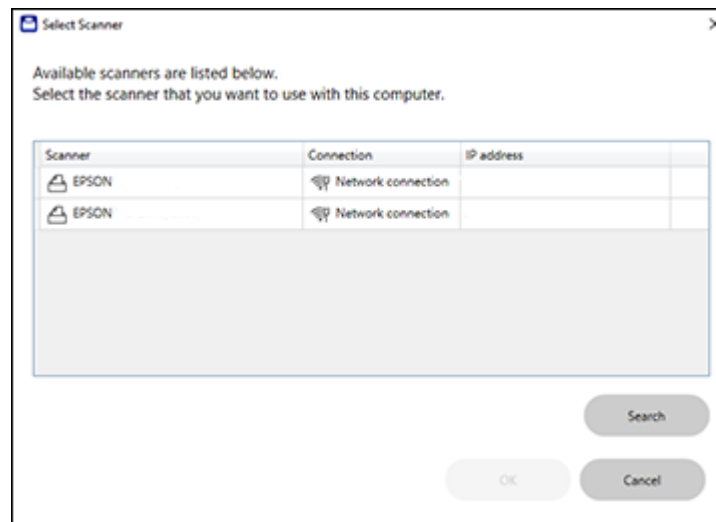

2. Select the Epson product you want to use with your computer and click **OK**.

**Parent topic:** [Selecting Epson ScanSmart Settings](#)

## Changing the Scan Settings

You can change detailed scan settings such as the resolution, document size, and more.

**Note:** If you select **Auto Mode**, you cannot change the scan settings.

1. Click the  **Settings** button.

You see a screen like this:

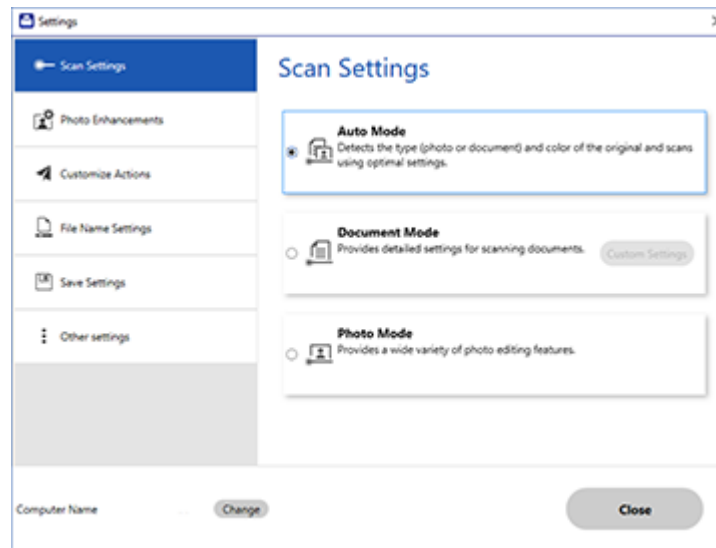

2. Do one of the following:

- To change Document Mode settings, select **Document Mode** > **Custom Settings**.
- To change Photo Mode settings, select **Photo Mode** and click **Close**. When you start a scan, you will be prompted to select scan settings.

You see a screen like this:

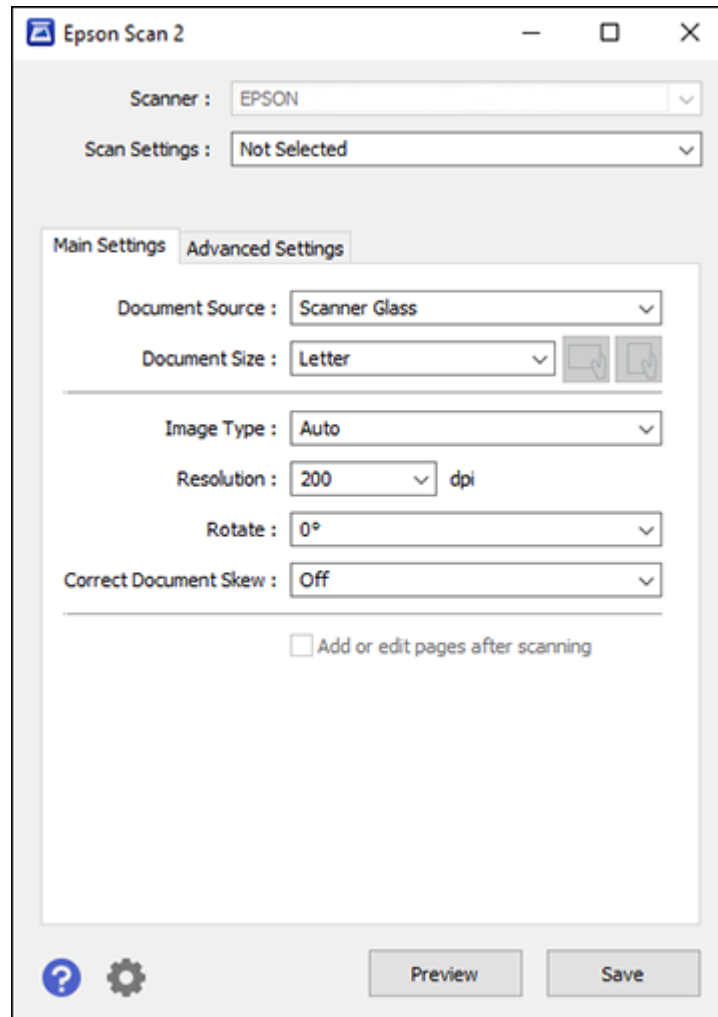

3. Change the settings as necessary and click **Save**.

**Parent topic:** [Selecting Epson ScanSmart Settings](#)

## Changing the File Name Settings

You can change the default file naming method for your scans.

1. Click the  **Settings** button.

You see a screen like this:

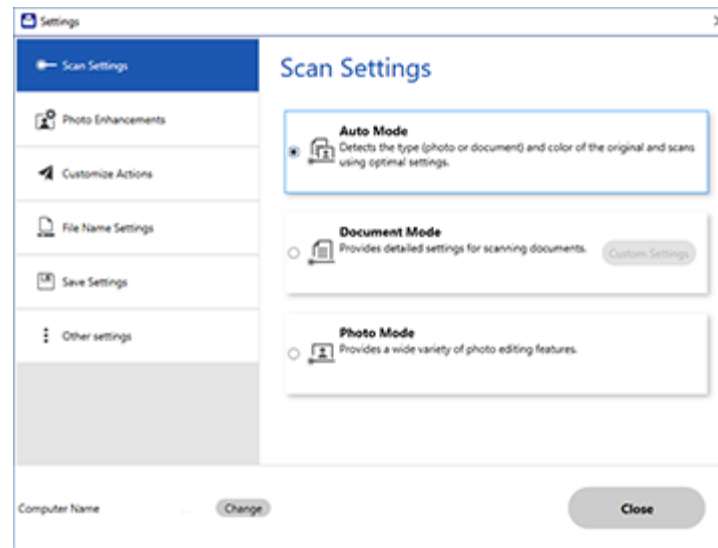

2. Click the **File Name Settings** tab.

You see a screen like this:

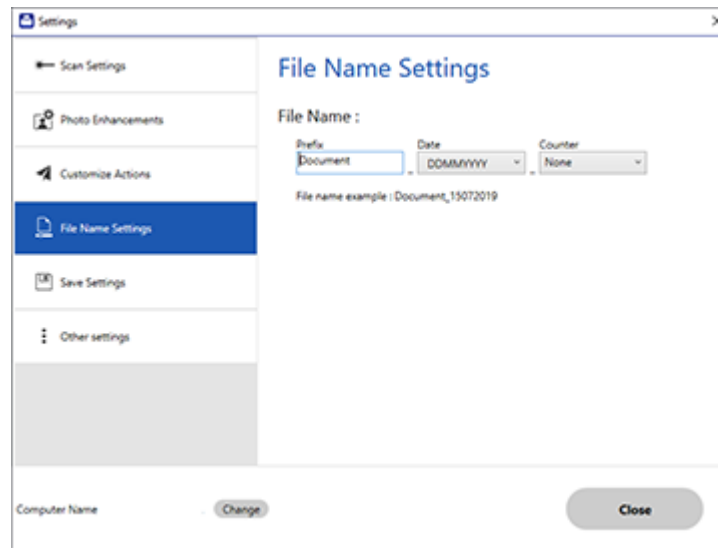

3. Change the settings as necessary:
  - Enter a prefix for the file name.
  - Select the date format.
  - Select a numbering format as the counter format.

4. Click **Close**.

**Parent topic:** [Selecting Epson ScanSmart Settings](#)

## Changing the Save Settings

You can change the file type options for saving your scans.

1. Click the  **Settings** button.

You see a screen like this:

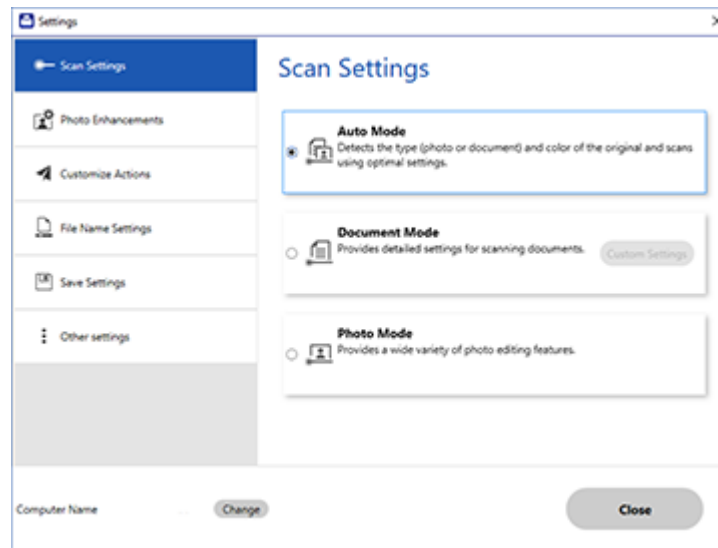

2. Click the **Save Settings** tab.

You see a screen like this:

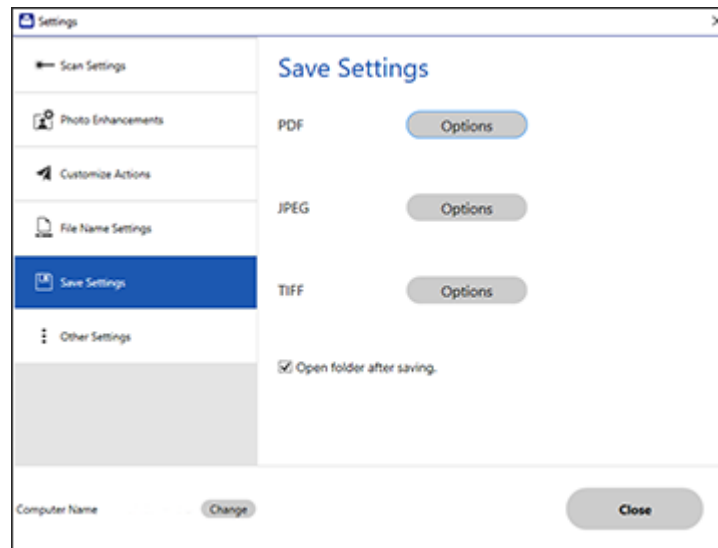

3. Click **Options** for a file format and change the settings as necessary.
4. Click **Open folder after saving** to open the file folder after a file is saved.
5. Click **Close**.

**Parent topic:** [Selecting Epson ScanSmart Settings](#)

## Save Settings

You can change the settings for how scanned images are saved.

### PDF Options

| Setting | Options                           | Description   |
|---------|-----------------------------------|---|
| General | <b>Generate PDF/A File</b>        | Creates a PDF that conforms to PDF/A-1 standards            |
|         | <b>Create file with all pages</b> | Saves all pages as one file                                 |
|         | <b>Compression Level</b>          | Selects the compression level for color or grayscale images |

## JPEG Options

| Setting                                 | Options            | Description  |
|---|--------------------|--|
| <b>Image Quality Options</b>            | —                  | Sets a compression level by moving a slider or entering a value. File size increases the higher the resolution is. |
| <b>Encoding</b> (Windows only)          | <b>Standard</b>    | Images load from top to bottom in a web browser. It takes longer to load the entire image.                         |
|   | <b>Progressive</b> | Images first load completely at low resolution and then adjust to high resolution in a web browser                 |
| <b>Embed ICC Profile</b> (Windows only) | —                  | Allows you to add ICC profiles to the image  |

## TIFF Options

| Setting                                 | Options                            | Description   |
|---|------------------------------------|---|
| <b>Byte Order</b>                       | <b>Windows</b><br><b>Macintosh</b> | Specifies the operating system where the scanned image will be used   |
| <b>Compression</b> (Windows only)       | —                                  | Specifies the compression format and level for Color/Grayscale and B&W images. File size increases with higher quality. |
| <b>Embed ICC Profile</b> (Windows only) | —                                  | Allows you to add ICC profiles to the image   |

Parent topic: [Selecting Epson ScanSmart Settings](#)

## Customizing Action Icons

You can customize which scan action icons appear on the **Select Action** screen.

**Note:** You can also customize them by clicking the **Customize** icon on the **Select Action** screen.

1. Click the  **Settings** button.



You see a screen like this:

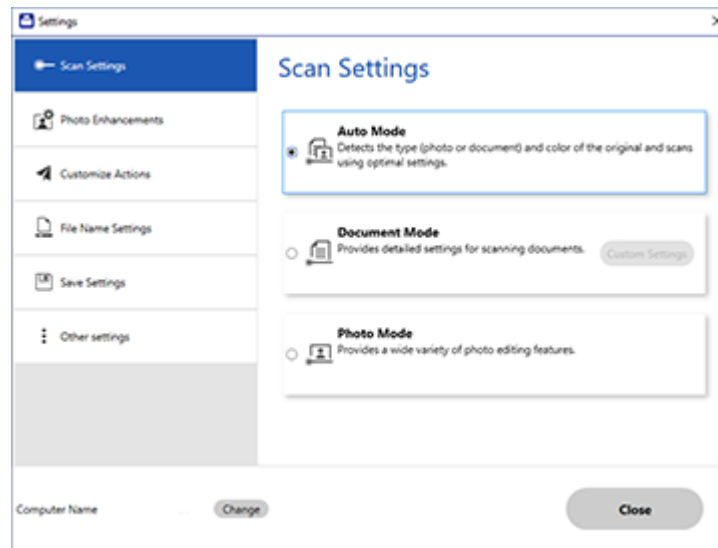

2. Click the **Customize Actions** tab.

You see a screen like this:

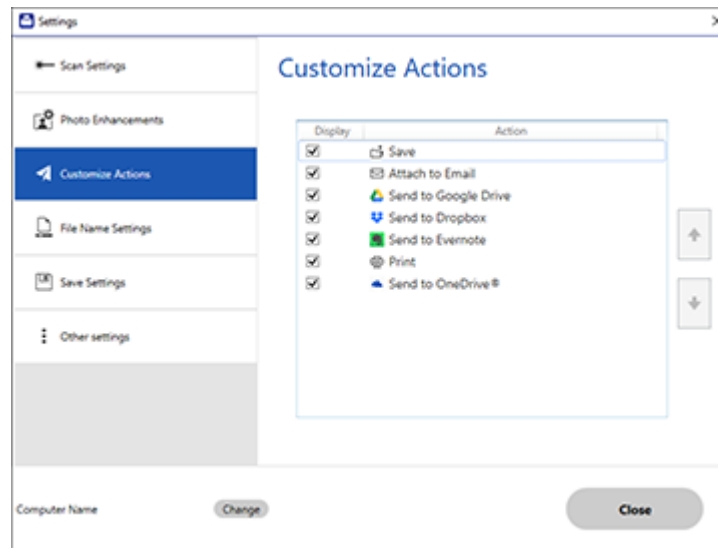

3. Choose which action icons to display by selecting or deselecting each checkbox. Click the arrow icons to move the icons up or down in the display order you want.
4. Click **Close**.

**Parent topic:** [Selecting Epson ScanSmart Settings](#)

## Scanning in Epson Scan 2

Epson Scan 2 gives you access to basic and advanced scanning features. You can scan your document and save the scanned image in various file formats in your operating system's Documents or My Documents folder, or open it in your scanning program. You can preview the scanned image and select or change settings as necessary.

**Note:** If you are using your Epson product with the Windows 10 S operating system, you cannot use the software described in this section. You also cannot download and install any Epson product software from the Epson website for use with Windows 10 S; you must obtain software only from the Windows Store.

1. Start Epson Scan 2.

You see this window:

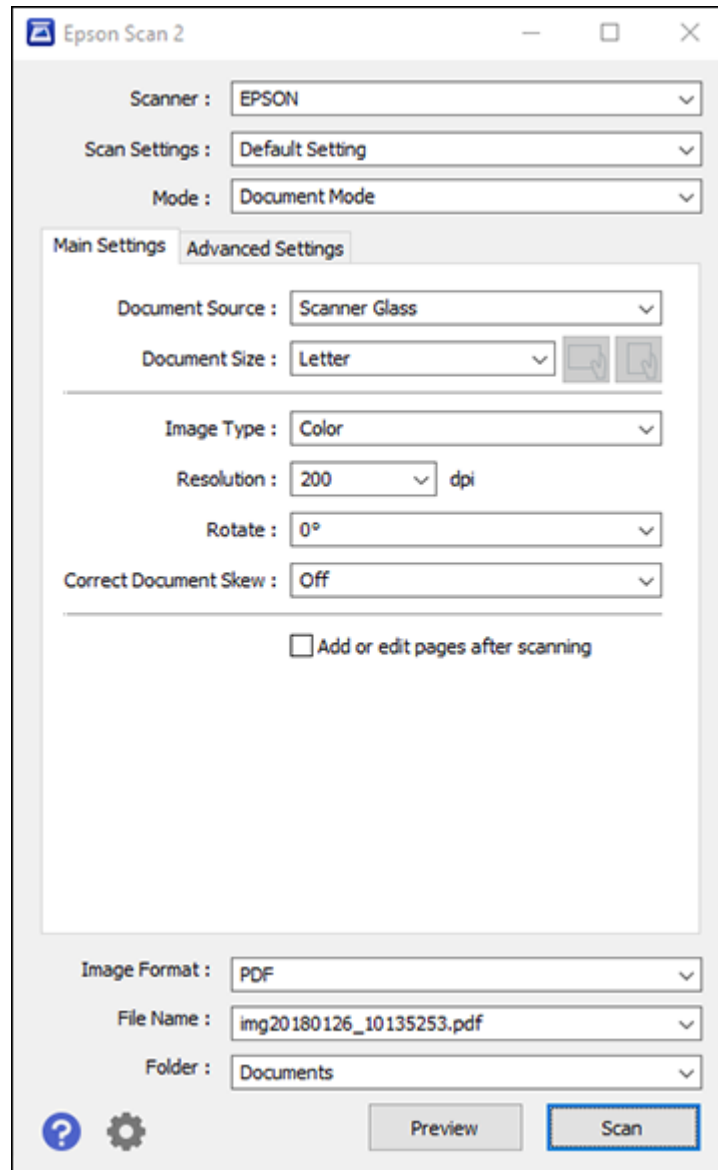

2. Select the **Mode** setting that matches the type of original you are scanning.
3. Select the **Document Source** setting that matches where you placed your original.
4. Select the **Document Size** setting that matches the size of your original. You can select **Customize** to enter a custom size, if necessary.
5. Select the image type of your original and how you want it scanned as the **Image Type** setting.
6. Select the **Resolution** setting you want to use for your scan.
7. Select the **Rotate** setting to rotate the scanned image.
8. Select the **Correct Document Skew** setting to correct skewed originals, image contents, or both.
9. Click the **Preview** button.

Epson Scan 2 previews your original and displays the results in the Epson Scan 2 window.

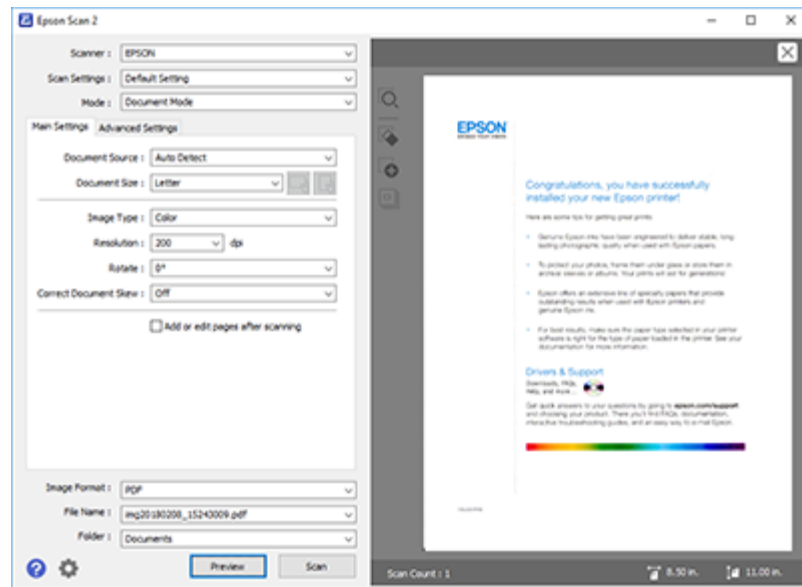

10. Do one of the following:
  - If you're scanning in Document Mode, select any of the additional settings that you want to use on the Main Settings tab.
  - If you're scanning in Photo Mode, select the **Color Management** and **Thumbnail Options** settings as necessary.

11. Click the **Advanced Settings** tab and select any settings that you want to use.
12. Select the format in which you want to save your scanned file as the **Image Format** setting. If necessary, select **Options** and select any desired format options.
13. Enter the file name for your scanned file in the **File Name** field. If necessary, select **Settings** to modify the file name settings.
14. Select the location in which you want to save your scanned file as the **Folder** setting. If necessary, select **Select** to create a new folder.
15. Click **Scan**.

The product scans your original and saves the scanned file in the location you specified.

[Additional Scanning Settings - Main Settings Tab](#)

[Additional Scanning Settings - Advanced Settings Tab](#)

[Saving Scanned Documents as a Searchable PDF Using Epson Scan 2](#)

[Image Format Options](#)

[Scan Resolution Guidelines](#)

**Parent topic:** [Scanning](#)

## Additional Scanning Settings - Main Settings Tab

You can select these additional scanning settings on the Epson Scan 2 Main Settings tab. Not all adjustment settings may be available, depending on other settings you have chosen.

### **Rotate**

Rotates the original image clockwise to the desired angle before scanning it. Select **Auto** to allow your product to automatically rotate the image based on the orientation of the text (may take longer to scan).

### **Correct Document Skew**

Corrects skewed originals, image contents, or both.

### **Add or edit pages after scanning**

Lets you add, remove, or edit the pages in a scan, including rotating pages and changing the page order.

**Note:** To save multiple pages in a single file, you must select a file format that supports multiple pages such as **PDF** or **Multi-TIFF**. If you select another file format, each scanned image or page is saved as a separate file.

**Parent topic:** [Scanning in Epson Scan 2](#)

## Additional Scanning Settings - Advanced Settings Tab

You can select these additional scanning settings on the Epson Scan 2 Advanced Settings tab. Not all adjustment settings may be available, depending on other settings you have chosen.

### **Remove Background**

Removes the background of the originals.

### **Text Enhancement**

Sharpens the appearance of letters in text documents.

### **Auto Area Segmentation**

Makes black and white images clearer and text recognition more accurate by separating the text from the graphics.

### **Threshold**

Adjusts the level at which black areas in text and line art are delineated, improving text recognition in OCR (Optical Character Recognition) programs.

### **Color Enhance**

Enhances the shades of the color you select in the scanned image. This setting is available only if you select **Grayscale** or **Black & White** as the Image Type setting.

### **Brightness**

Adjusts the overall lightness and darkness of the scanned image.

### **Contrast**

Adjusts the difference between the light and dark areas of the overall scanned image.

### **Gamma**

Adjusts the midtone density of the scanned image.

### **Unsharp Mask**

Makes the edges of certain image areas clearer. Turn off this option to leave softer edges.

### **Descreening**

Removes the ripple pattern that might appear in subtly shaded image areas, such as skin tones. This option improves results when scanning magazines or newspapers. (The results of descreening do not appear in the preview image, only in your scanned image.)

### **Edge Fill**

Corrects shadowing around the edges of the image by filling the shadows with black or white.

### **Dual Image Output**

Scans the original image twice using different output settings (Windows only).

### **Watermark**

Adds a watermark to a scanned image.

Parent topic: [Scanning in Epson Scan 2](#)

## Saving Scanned Documents as a Searchable PDF Using Epson Scan 2

You can scan a document and save the text in a searchable PDF. In a searchable PDF, text is recognized using Optical Character Recognition (OCR) and then embedded in the scanned original.

**Note:** The required Epson Scan 2 OCR Component is installed automatically when you install your product software from the CD included with your product. If you are downloading your product's software, you must download and install the required Epson Scan 2 OCR Component to scan using OCR with Epson Scan 2. Select **Epson Software Updater** in the Windows **Start** menu or Mac **Epson Software** folder, and select the component and PDF extension files to download and install them.

1. Load your original in the product for scanning.
2. Start Epson Scan 2.
3. Select your scan settings.
4. Click **Preview** and adjust the area you want to scan, if necessary.
5. Select **Searchable PDF** as the Image Format setting.
6. Select **Options** from the Image Format list.

You see this window:

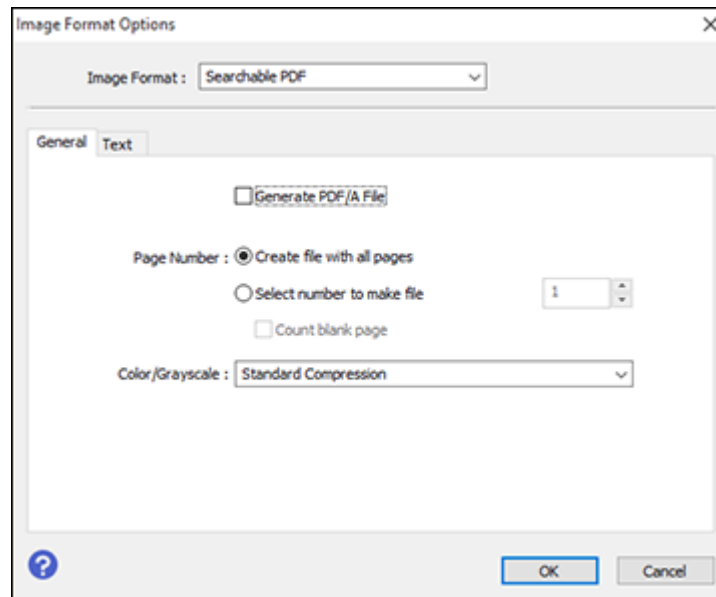

7. Select any of the options on the General tab.
8. Select the **Text** tab.
9. Make sure the language used in the document text is selected as the **Text Language** setting.
10. Click **OK**.
11. Confirm the **File Name** setting and select a **Folder** setting for your document.
12. Click **Scan**.

The scanned image is saved as a searchable PDF.

Parent topic: [Scanning in Epson Scan 2](#)

## Image Format Options

You can select different image formats and related options. For details on available options, click the ? icon on the Epson Scan 2 Image Format Options window. Not all image formats have options.

### **BITMAP (\*.bmp)**

A standard image file format for most Windows programs.



**JPEG (\*.jpg)**

An image format that lets you highly compress image data. However, the higher the compression, the lower the image quality. (The TIFF format is recommended when you need to modify or retouch your scanned image.)

**PNG (\*.png)**

An image format that does not lose quality during editing.

**TIFF (\*.tif)**

A file format created for exchanging data between many programs, such as graphic and DTP software.

**Multi-TIFF (\*.tif)**

A TIFF file format when multiple pages are saved to the same file, allowing you to edit the images using a compatible program.

**PDF (\*.pdf)**

A document format that is readable by Windows and Mac systems using Adobe Reader, Acrobat, or other programs. You can save multi-page documents in one PDF file.

**Searchable PDF (\*.pdf)**

A document format that is readable by Windows and Mac systems using Adobe Reader, Acrobat, or other programs. You can save multi-page documents in one PDF file. Recognized text in the scanned document can be searched.

Parent topic: [Scanning in Epson Scan 2](#)

## Scan Resolution Guidelines

The **Resolution** setting, measured in dpi (dots per inch), controls the amount of detail captured in your scans. Increasing the resolution raises the amount of detail captured but comes with the following disadvantages:

- Larger file sizes
- It takes longer to scan your originals, send/receive your scans by email or fax, and to print your scans
- The image may become too large to fit on your display or print on paper

If you plan to enlarge a scanned image so you can print it at a larger size, you may need to increase the resolution from the default resolution set by Epson Scan 2. Follow these guidelines to determine the resolution setting you need:

- You will scan the image at its original size but enlarge it later in an image-editing program.

Increase the Epson Scan 2 Resolution setting in your scan. Increase the resolution by the same amount you will increase the image size to retain a high image quality. For example, if the resolution is

300 dpi (dots per inch) and you will double the image size later, change the Resolution setting to 600 dpi.

- You will scan the image at 100% or a smaller size.

Select the Epson Scan 2 Resolution setting based on how you will use the scanned image:

- Email/view on a computer screen/post on the web: 96 to 200 dpi
- Print/fax/convert to editable text (OCR)/create searchable PDF: 200 to 300 dpi

**Parent topic:** [Scanning in Epson Scan 2](#)

---

# Refilling Ink

When the ink level is below the lower line on an ink tank, you need to refill it.

**Caution:** If the ink level is below the lower line on the ink tank, fill it to the upper line on the ink tank. Continued use of the product when the ink level is below the lower line on a tank could damage the product.

[Ink Safety Precautions](#)

[Checking Ink Levels on Your Product](#)

[Disabling Special Offers with Windows](#)

[Purchase Epson Ink](#)

[Refilling the Ink Tanks](#)

## Ink Safety Precautions

### Ink Handling Precautions

- Keep ink bottles and the ink tanks out of the reach of children. Do not allow children to drink from or handle the ink bottles and bottle caps.
- Do not tilt or shake an ink bottle after opening it; otherwise, ink may leak.
- Be careful not to touch any ink when you handle the ink tanks, ink tank caps, and opened ink bottles or ink bottle caps.
- If ink gets on your skin, wash it thoroughly with soap and water. If ink gets into your eyes, flush them immediately with water. If ink gets into your mouth, spit it out and see a doctor right away.
- Do not squeeze the ink bottles.
- If ink spills, wipe it up immediately. To prevent the ink from spreading, blot the spill with a dry cloth, then wipe it with a damp cloth. The ink will be hard to remove once it has dried.

### Ink Refilling Precautions

- Use ink bottles with the correct part number for this product.
- Do not mix with other Epson ink types.
- The use of non-Epson ink may cause damage that is not covered by Epson's warranty, and under certain circumstances, may cause erratic product behavior.

- This product requires careful handling of ink. Ink may splatter when the ink tanks are filled or refilled with ink. If ink gets on your clothes or belongings, it may not come off.
- Do not open the ink bottle package until you are ready to fill an ink tank. Ink bottles are vacuum packed to maintain reliability. If you leave an ink bottle unpacked for a long time before using it, print quality may be affected.
- If the ink level is below the lower line on an ink tank, refill the ink. Continued use of the product when the ink level is below the lower line on an ink tank could damage the product.
- Visually check the ink levels in the product's ink tanks to confirm the actual ink levels. Continued use of the product when the ink is below the lower line on an ink tank could damage the product.
- Do not maintain low ink levels for extended periods of time.
- Epson recommends filling all ink tanks to the upper line when the product is not operating.
- After bringing an ink bottle inside from a cold storage site, allow it to warm up at room temperature for at least three hours before using it.
- Use the ink bottle before the date printed on the package.
- After opening an ink bottle, Epson recommends using it as soon as possible.
- Wipe off any ink around the tanks and ports with a clean, lint-free cloth or cotton swab.
- Store ink bottles in a cool, dark place. Keep them out of direct sunlight.
- Do not store the ink bottles in high or freezing temperatures.
- Store the ink bottles in the same environment as the product. When storing or transporting an opened ink bottle, do not tilt the bottle and do not subject it to impacts or temperature changes. Otherwise, ink may leak even if the cap on the ink bottle is tightened securely. Be sure to keep the ink bottle upright when tightening the cap, and take measures to prevent ink from leaking when you transport the bottle.

### **Ink Bottle and Ink Tank Information**

- To maintain optimum print head performance, some ink is consumed from all ink tanks during printing and when performing maintenance operations, such as cleaning the print head. Ink may also be consumed when the product is turned on.
- Some ink in the ink bottles supplied with your product is used during initial setup; these ink bottles will print fewer pages compared to subsequent ink bottles.
- Quoted ink yields may vary depending on the images you are printing, the paper type you are using, how often you print, and environmental conditions such as temperature.
- The ink bottles may contain recycled materials, but this does not affect product function or performance.

- The specification and appearance of the ink bottles are subject to change without prior notice for improvement.
- When printing in monochrome or grayscale, color ink may be used instead of black ink, depending on the paper type or print quality settings. This is because a mixture of color inks is used to create black.

**Parent topic:** [Refilling Ink](#)

## Checking Ink Levels on Your Product

To confirm the actual ink levels, visually check the ink levels in the product's ink tanks. Make sure the ink levels are above the lower lines on the ink tanks. If any of the ink tanks are below the lower line, fill them up to the upper line on the ink tank.

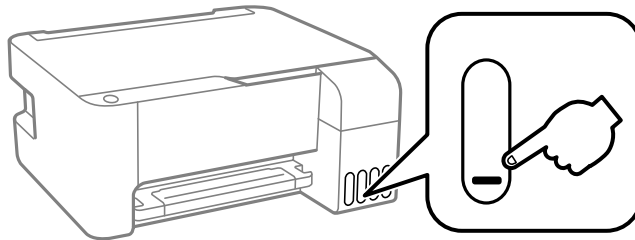

**Parent topic:** [Refilling Ink](#)

### **Related references**

[Ink Safety Precautions](#)



### **Related tasks**

[Refilling the Ink Tanks](#)

## Disabling Special Offers with Windows

You can disable special offers messages from Epson using a utility on your Windows computer.

**Note:** You may see the Epson Special Offers screen every time you print (if your computer is connected to the Internet). Select **Do not display this message again** and click **Decline** to disable online offers. Promotional offers are not valid in Latin America.

1. Access the Windows Desktop and right-click the  icon for your product in the right side of the Windows taskbar, or click the up arrow and right-click . Select **Monitoring Preferences**.

You see this window:

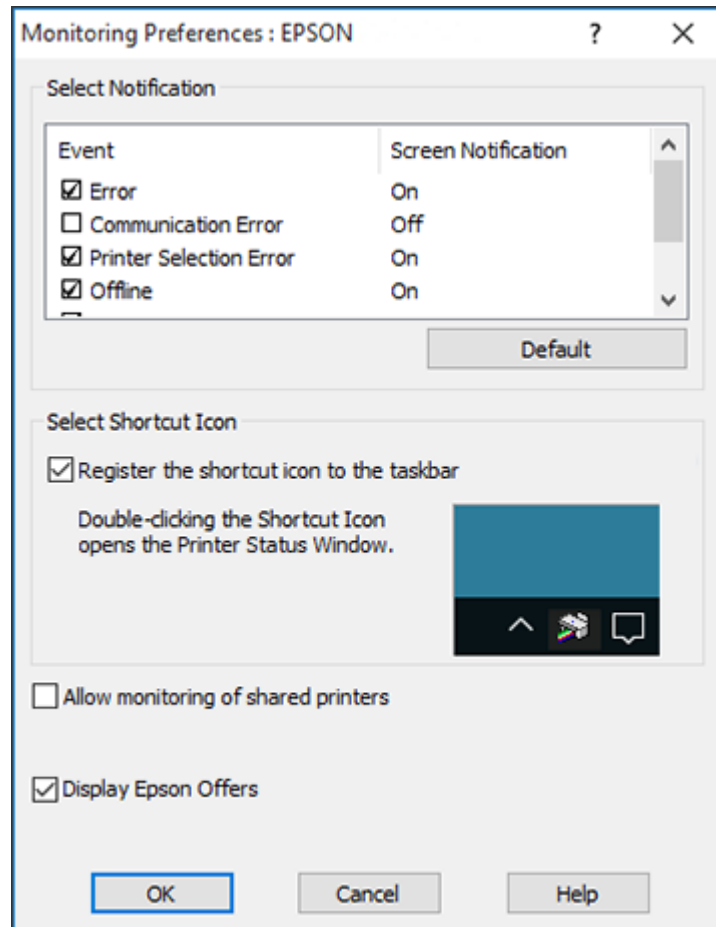

2. To disable promotional offers, deselect the **Display Epson Offers** checkbox.

Parent topic: [Refilling Ink](#)

## Purchase Epson Ink

You can purchase genuine Epson ink and paper from an Epson authorized reseller. To find the nearest reseller, visit [latin.epson.com](http://latin.epson.com) or call your nearest Epson sales office.

**Note:** This product is designed to work with genuine Epson inks. Non-Epson ink or any other ink not specified for this printer could cause damage not covered by Epson's warranties.

The ink bottles that are used for initial product setup have a lower yield due to the ink charging process. This process is carried out the first time you turn on the printer and guarantees better performance. Yields vary considerably based on print jobs, print settings, paper type, frequency of use, and temperature. Do not load paper before refilling the ink tanks.

Check the ink levels in your product frequently, and refill the ink tanks if necessary.

[Ink Bottle Part Numbers](#)

**Parent topic:** [Refilling Ink](#)

## Ink Bottle Part Numbers

Use these part numbers when you order or purchase new ink bottles.

| Ink color | Part number |
|-----------|-------------|
| Black     | T544120-AL  |
| Cyan      | T544220-AL  |
| Magenta   | T544320-AL  |
| Yellow    | T544420-AL  |

**Parent topic:** [Purchase Epson Ink](#)

## Refilling the Ink Tanks

Make sure you have new ink bottles handy and have read the ink safety precautions before you begin.

You can continue to use the product even if one or more ink tanks are not filled all the way.

**Caution:** Wear disposable gloves while refilling the ink tanks to avoid staining your hands. If ink spills, wipe it off immediately with a damp towel to avoid permanent stains. If ink gets on your clothes or belongings, it may not come off.

1. Open the ink tank cover.

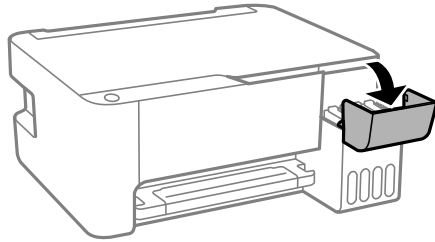

2. Open the cap for the ink tank you are going to fill.

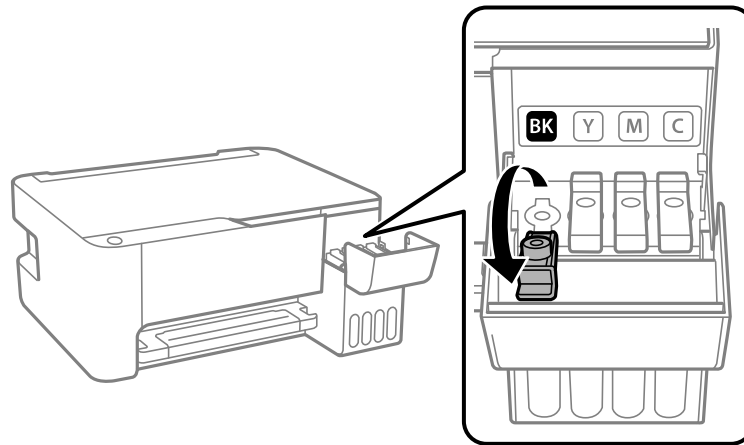

**Note:** Make sure the color of the ink tank label matches the ink color you want to fill.



3. Hold the ink bottle upright and slowly turn the bottle cap to remove it.



**Caution:** Do not shake or squeeze the bottle. Do not touch the top of the bottle after removing its cap.

**Warning:** If ink gets on your skin, wash it thoroughly with soap and water. If ink gets into your eyes, flush them immediately with water. If ink gets into your mouth, spit it out and see a doctor right away. Seek medical advice if problems persist. Keep the ink bottles out of the reach of children and do not drink the ink.

4. Check the upper line (a) on the ink tank.

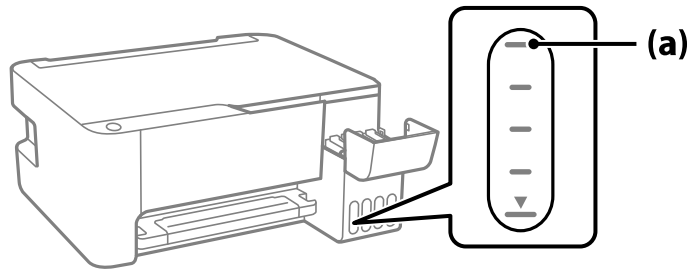

5. Position the top of the ink bottle along the slot in front of the filling port, then slowly stand the bottle up to insert it. Wait for the ink to fill the tank. Do not squeeze the bottle. Ink flows into the tank and stops automatically when the ink is filled to the upper line.

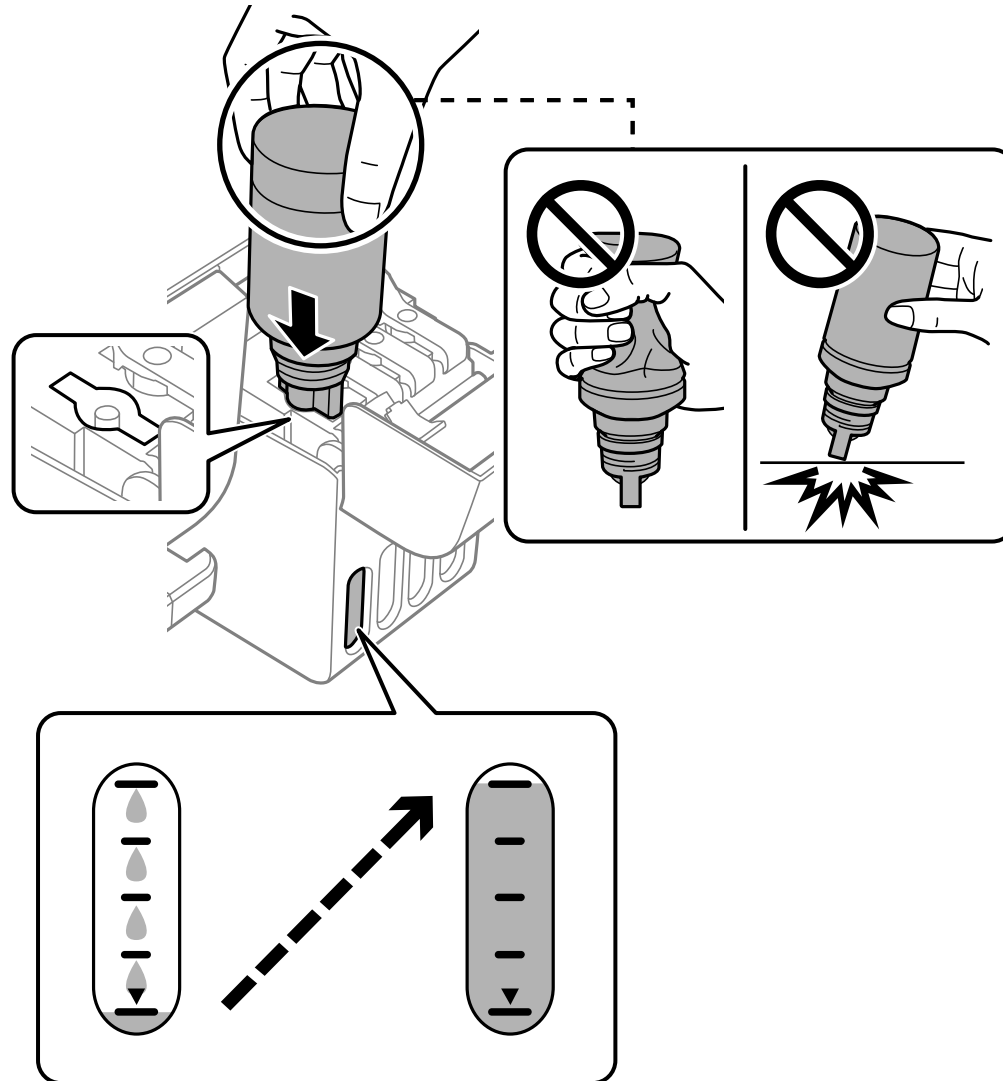

**Note:** Do not force the bottles into position; they are keyed for each color.

**Note:** If ink does not flow from the bottle, lift and reinsert the bottle. However, do not remove and reinsert the ink bottle when the ink has reached the upper line; otherwise ink may leak.

6. When the ink tank is full, remove the ink bottle and securely close the ink tank cap as shown.

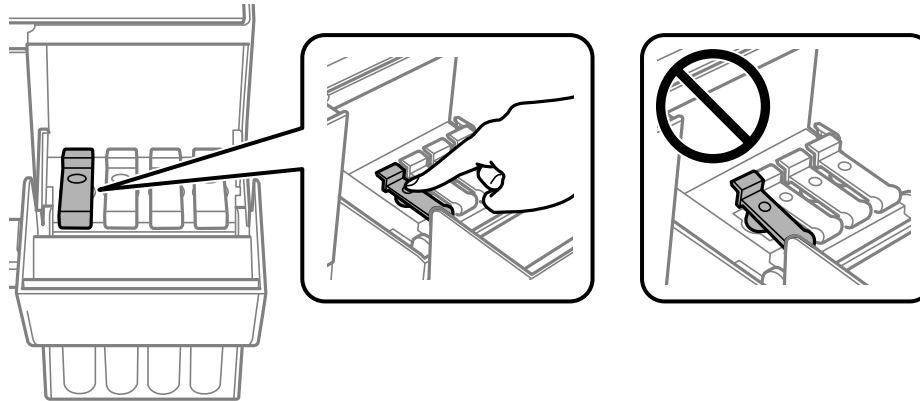

**Note:** Do not leave the ink bottle inserted; otherwise the bottle may be damaged or ink may leak.

**Note:** If any ink remains in the bottle, replace the bottle cap and tighten it. Store the bottle upright for later use.

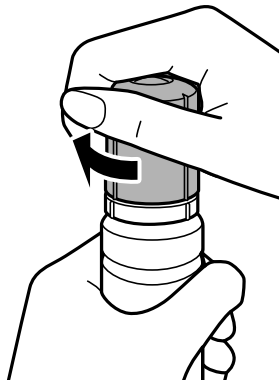

7. Repeat the previous steps as necessary for each ink tank you need to fill.
8. Close the ink tank cover.

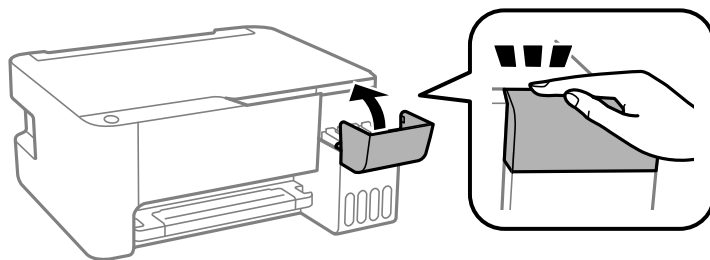

**Parent topic:** [Refilling Ink](#)

**Related concepts**

[Purchase Epson Ink](#)

**Related references**

[Ink Safety Precautions](#)

---

## Adjusting Print Quality

If your print quality declines, you may need to run a utility to clean or align the print head.

If running these utilities does not solve the problem, you may need to run a Power Cleaning or clean the paper path.

[Print Head Maintenance](#)

[Print Head Alignment](#)

[Cleaning the Paper Path](#)

[Checking the Number of Sheets Fed](#)

## Print Head Maintenance

If your printouts become too light, or you see dark or light bands across them, you may need to clean the print head nozzles. Cleaning uses ink, so clean the nozzles only if print quality declines.

You can check for clogged nozzles before you clean them so you don't clean them unnecessarily.

**Note:** You may not be able to clean the print head when the ink level in any of the tanks is low. You may have to refill the ink tank first.

If you still see white or dark lines or gaps in your printouts, even after cleaning the print head several times, you can run a Power Cleaning.

[Print Head Nozzle Check](#)

[Print Head Cleaning](#)

[Power Cleaning](#)

**Parent topic:** [Adjusting Print Quality](#)

**Related topics**

[Refilling Ink](#)

## Print Head Nozzle Check

You can print a nozzle check pattern to check for clogged nozzles.

[Checking the Nozzles Using the Product Buttons](#)

[Checking the Nozzles Using a Computer Utility](#)

**Parent topic:** [Print Head Maintenance](#)

## Checking the Nozzles Using the Product Buttons

You can check the print head nozzles using the buttons on your product.

1. Press the ⏻ power button to turn the product off.
2. Load a few sheets of plain paper in the product.
3. Hold down the ⏹ stop button and press the ⏻ power button to turn the product on.
4. When the product turns on, release both buttons.

The product prints a nozzle check pattern.

**Note:** It can take a few seconds for the nozzle check pattern to start printing. If it does not start printing after a few seconds, make sure there is paper loaded in the product.

5. Check the printed pattern to see if there are gaps in the lines.

**Print head is clean**

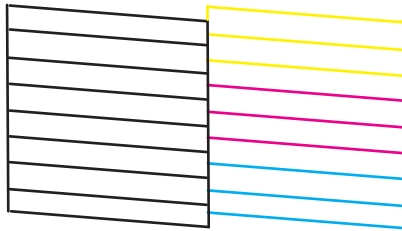

**Print head needs cleaning**

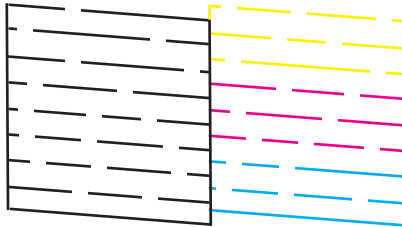

**Print head needs Power Cleaning**

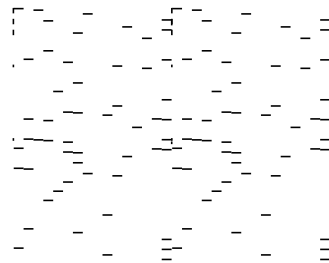

6. Do one of the following:
- If there are no gaps, the print head is clean and you can continue printing.
  - If there are gaps or the pattern is faint, clean the print head.

- If almost the entire pattern is missing, see the link below for instructions on performing a Power Cleaning.

If you don't see any improvement after cleaning the print head up to 3 times, turn off the product and wait at least 12 hours. Then run a nozzle check and try cleaning the print head again. If quality still does not improve, run a Power Cleaning.

**Parent topic:** [Print Head Nozzle Check](#)

#### **Related concepts**

[Power Cleaning](#)



#### **Related tasks**

[Loading Paper in the Sheet Feeder](#)

[Cleaning the Print Head Using the Product Buttons](#)

### **Checking the Nozzles Using a Computer Utility**

You can check the print head nozzles using a utility on your Windows or Mac computer.

1. Load a few sheets of plain paper in the product.
2. Do one of the following:
  - **Windows:** Access the Windows Desktop and right-click the  icon for your product in the right side of the Windows taskbar, or click the up arrow and right-click .
  - **Mac:** In the Apple menu or the Dock, select **System Preferences**. Select **Print & Fax**, **Print & Scan**, or **Printers & Scanners**, select your product, and select **Options & Supplies**. Select **Utility** and select **Open Printer Utility**.
3. Select **Print Head Nozzle Check**.



You see a window like this:

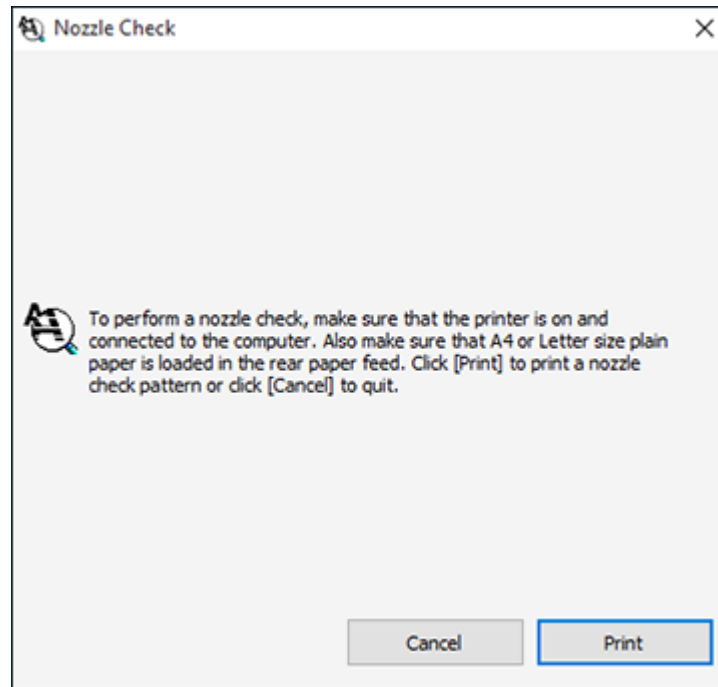

4. Click **Print**.

5. Check the printed pattern to see if there are gaps in the lines.

**Print head is clean**

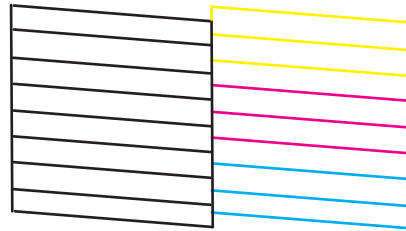

**Print head needs cleaning**

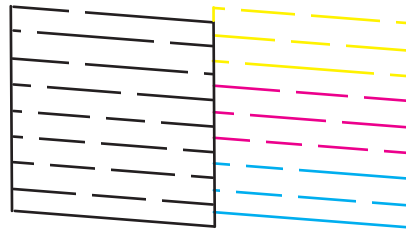

**Print head needs Power Cleaning**

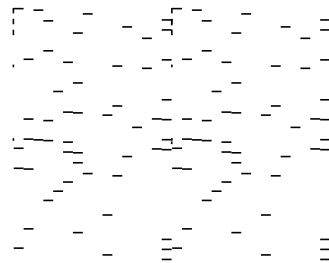

6. Do one of the following:
- If there are no gaps, click **Finish**.
  - If there are gaps or the pattern is faint, clean the print head.

- If almost the entire pattern is missing, click **Finish** and perform a Power Cleaning.

If you don't see any improvement after cleaning the print head up to 3 times, turn off the product and wait at least 12 hours. Then run a nozzle check and try cleaning the print head again. If quality still does not improve, run a Power Cleaning.

**Parent topic:** [Print Head Nozzle Check](#)

**Related concepts**

[Power Cleaning](#)

**Related tasks**

[Loading Paper in the Sheet Feeder](#)

[Cleaning the Print Head Using a Computer Utility](#)

## Print Head Cleaning

If print quality has declined and the nozzle check pattern indicates clogged nozzles, you can clean the print head.

**Note:** You may not be able to clean the print head when the ink level in any of the tanks is low. You may have to refill the ink tank first.

[Cleaning the Print Head Using the Product Buttons](#)

[Cleaning the Print Head Using a Computer Utility](#)

**Parent topic:** [Print Head Maintenance](#)

**Related topics**

[Refilling Ink](#)

### Cleaning the Print Head Using the Product Buttons

You can clean the print head using the buttons on your product.

1. Make sure no product lights are indicating errors.
2. Load a few sheets of plain paper in the product.
3. Hold down the  stop button for five seconds to start the cleaning cycle.

The  power light flashes throughout the cleaning cycle and stays on when the cleaning cycle is finished.

**Caution:** Never turn off the product or open the front cover during a cleaning cycle or you may not be able to print.

4. Run a nozzle check to confirm that the print head is clean.

**Print head is clean**

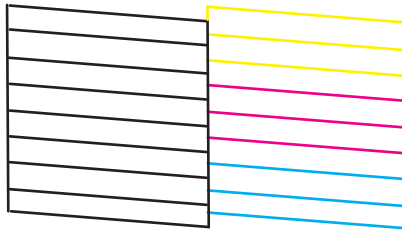

**Print head needs cleaning**

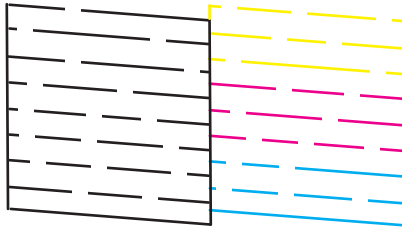

**Print head needs Power Cleaning**

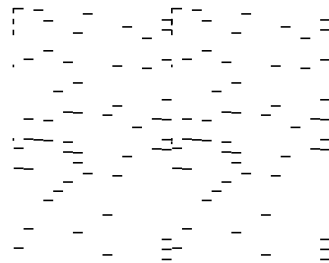

5. Do one of the following:
  - If there are no gaps, the print head is clean and you can continue printing.
  - If there are gaps or the pattern is faint, clean the print head.

- If almost the entire pattern is missing, see the link below for instructions on performing a Power Cleaning.

If you don't see any improvement after cleaning the print head up to 3 times, turn off the product and wait at least 12 hours. Then try cleaning the print head again. If quality still does not improve, run a Power Cleaning. If there is still no improvement, contact Epson support.

**Parent topic:** [Print Head Cleaning](#)

**Related concepts**

[Power Cleaning](#)

**Related references**

[Where to Get Help](#)



**Related tasks**

[Loading Paper in the Sheet Feeder](#)

[Checking the Nozzles Using the Product Buttons](#)

### **Cleaning the Print Head Using a Computer Utility**

You can clean the print head using a utility on your Windows or Mac computer.

1. Make sure no product lights are indicating errors.
2. Load a few sheets of plain paper in the product.
3. Do one of the following:
  - **Windows:** Access the Windows Desktop and right-click the  icon for your product in the right side of the Windows taskbar, or click the up arrow and right-click .
  - **Mac:** In the Apple menu or the Dock, select **System Preferences**. Select **Print & Fax**, **Print & Scan**, or **Printers & Scanners**, select your product, and select **Options & Supplies**. Select **Utility** and select **Open Printer Utility**.
4. Select **Head Cleaning**.

You see a window like this:

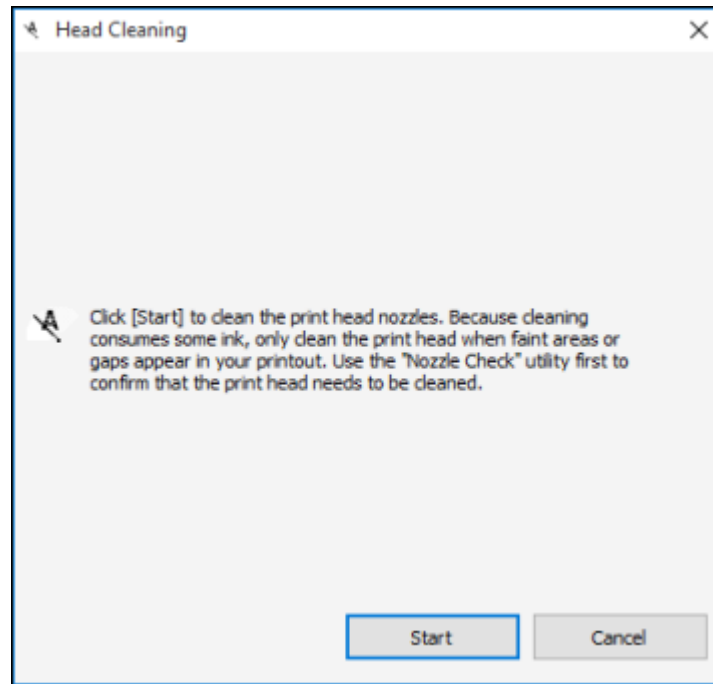

5. Click **Start** to begin the cleaning cycle.

**Caution:** Never turn off the product or open the front cover during a cleaning cycle or you may not be able to print.

6. When the cleaning cycle is finished, you can check to see if the nozzles are clean; click **Print Nozzle Check Pattern** and click **Print**.

7. Check the printed pattern to see if there are gaps in the lines.

**Print head is clean**

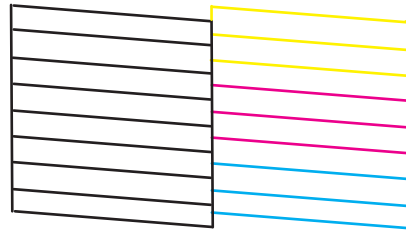

**Print head needs cleaning**

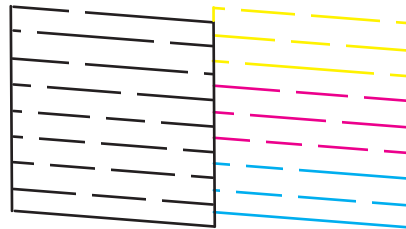

**Print head needs Power Cleaning**

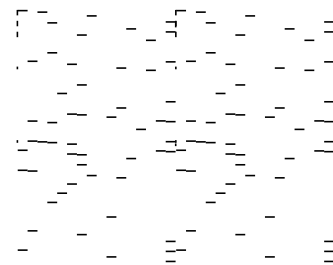

- If there are no gaps, click **Finish**.
- If there are gaps or the pattern is faint, click **Clean** to clean the print head again.
- If almost the entire pattern is missing, click **Finish** and perform a Power Cleaning.

If you don't see any improvement after cleaning the print head up to 3 times, turn off the product and wait at least 12 hours. Then check the print head nozzles and try cleaning the print head again. If quality still does not improve, run a Power Cleaning. If there is still no improvement, contact Epson support.

**Parent topic:** [Print Head Cleaning](#)

**Related concepts**

[Power Cleaning](#)

**Related references**

[Where to Get Help](#)

**Related tasks**

[Loading Paper in the Sheet Feeder](#)

[Checking the Nozzles Using a Computer Utility](#)

## Power Cleaning

If you still see white or dark lines or missing nozzles in your printouts, even after cleaning the print head several times, you can run a Power Cleaning.

If you do not see improvement after running a Power Cleaning, turn off the product and wait at least 12 hours before running another Power Cleaning.

**Caution:** Running a Power Cleaning consumes a lot of ink, so you should run it only if necessary. Make sure each ink tank is at least one-third full before running a Power Cleaning, or it may damage the product.

**Caution:** Power Cleaning may cause the ink pads to reach their capacity sooner. When an ink pad reaches the end of its service life, the product stops printing and you must contact Epson for support.

[Power Cleaning Using a Computer Utility](#)

**Parent topic:** [Print Head Maintenance](#)

**Related topics**



[Refilling Ink](#)

### Power Cleaning Using a Computer Utility

You can run a Power Cleaning using a utility on your Windows or Mac computer.

**Note:** After running a Power Cleaning, you must turn off the product and wait at least 12 hours before running another Power Cleaning.



1. Make sure no product lights are indicating errors.
2. Load a few sheets of plain paper in the product.
3. Do one of the following:
  - **Windows:** Access the Windows Desktop and right-click the  icon for your product in the right side of the Windows taskbar, or click the up arrow and right-click . Select **Printer Settings** and click the **Maintenance** tab.
  - **Mac:** In the Apple menu or the Dock, select **System Preferences**. Select **Print & Fax**, **Print & Scan**, or **Printers & Scanners**, select your product, and select **Options & Supplies**. Select **Utility** and select **Open Printer Utility**.
4. Select **Power Cleaning**.  
You see a window like this:

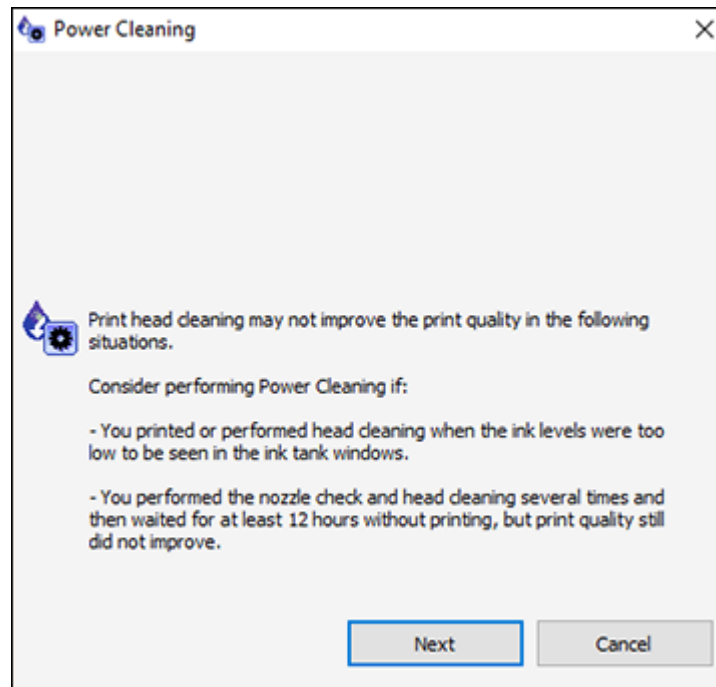

5. Follow the on-screen instructions to run a Power Cleaning.

6. When Power Cleaning is finished, run a nozzle check.

If print quality has not improved after running Power Cleaning, wait for at least 12 hours without printing, and then print the nozzle check pattern again. Run Print Head Cleaning or Power Cleaning again depending on the printed pattern. If quality still does not improve, contact Epson support.

**Parent topic:** [Power Cleaning](#)

**Related concepts**

[Print Head Nozzle Check](#)

**Related references**

[Product Light Status](#)

[Where to Get Help](#)

**Related tasks**

[Loading Paper in the Sheet Feeder](#)

## Print Head Alignment

If your printouts become grainy or blurry, you notice misalignment of vertical lines, or you see dark or light horizontal bands, you may need to align the print head.

**Note:** Banding may also occur if your print head nozzles need cleaning.

[Aligning the Print Head Using a Computer Utility](#)

**Parent topic:** [Adjusting Print Quality](#)

**Related concepts**



[Print Head Cleaning](#)

**Related tasks**

[Loading Paper in the Sheet Feeder](#)

## Aligning the Print Head Using a Computer Utility

You can align the print head using a utility on your Windows or Mac computer.

1. Load a few sheets of plain paper in the product.
2. Do one of the following:
  - **Windows:** Access the Windows Desktop and right-click the  icon for your product in the right side of the Windows taskbar, or click the up arrow and right-click .

- **Mac:** In the Apple menu or the Dock, select **System Preferences**. Select **Print & Fax**, **Print & Scan**, or **Printers & Scanners**, select your product, and select **Options & Supplies**. Select **Utility** and select **Open Printer Utility**.
3. Select **Print Head Alignment**.
  4. Click **Next**, then click **Print** to print an alignment sheet.

**Note:** Do not cancel printing while you are printing a head alignment pattern.

You see a window like this:

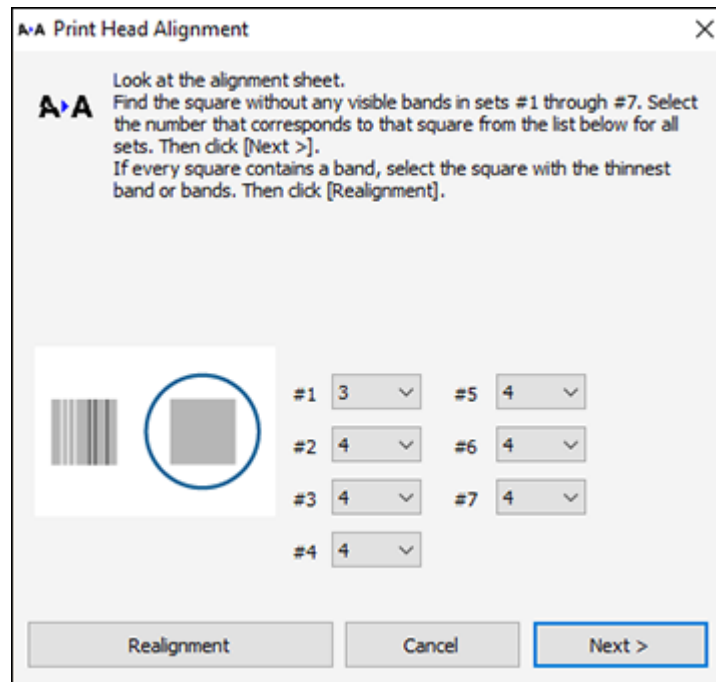

5. Check the printed pattern and follow the instructions on the screen to choose the number of the best printed pattern for each set.

### Vertical alignment

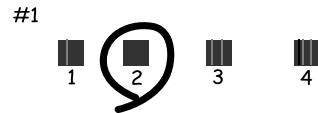

### Horizontal alignment



- After choosing a pattern number, click **Next**.
- If no patterns are aligned in one or more of the sets, choose the closest one in each set and click **Realignment**. Then print another alignment sheet and check it.

**Note:** Click **Skip** (where available) if you want to skip a particular alignment sheet.

6. When you are done, click **Finish**.

**Parent topic:** [Print Head Alignment](#)

### Related tasks

[Loading Paper in the Sheet Feeder](#)

## Cleaning the Paper Path

If you see ink on the back of a printout, you can clean the paper path to remove any excess ink.

**Caution:** Do not use tissues to clean the rollers inside the product; lint from tissue may clog the print head nozzles.

1. Load a few sheets of plain paper in the product.
2. Use the product control panel to make a copy, but without placing a document on the scanner glass.

**Note:** Make sure there is no dust or stains on the scanner glass or document cover.

3. Check the back of the ejected paper to see if it is clean.
4. Repeat as necessary until the paper comes out clean.

**Parent topic:** [Adjusting Print Quality](#)

**Related tasks**

[Loading Paper in the Sheet Feeder](#)

**Related topics**

[Copying](#)

## Checking the Number of Sheets Fed

You can view an option that displays the number of sheets of paper that have fed through the product.

**Note:** You can also view the number of sheets of paper fed through the product by printing a nozzle check.



[Checking the Sheet Counter - Windows](#)

[Checking the Sheet Counter - Mac](#)

**Parent topic:** [Adjusting Print Quality](#)

## Checking the Sheet Counter - Windows

You can check the number of sheets of paper that have fed through the product by checking the sheet counter.

1. Access the Windows Desktop and right-click the  icon for your product in the right side of the Windows taskbar, or click the up arrow and right-click .
2. Select **Printer Settings**.
3. Click the **Maintenance** tab.
4. Select **Printer and Option Information**.

You see this window:

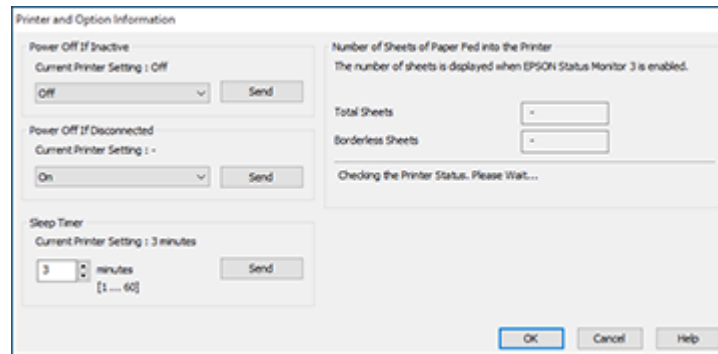

5. After checking the number of sheets fed into the printer, click **OK** to close the window.

**Note:** The number of sheets is displayed only when Epson Status Monitor 3 is enabled.

**Parent topic:** [Checking the Number of Sheets Fed](#)

## Checking the Sheet Counter - Mac

You can check the number of sheets of paper that have fed through the product by checking the sheet counter.

1. In the Apple menu or the Dock, select **System Preferences**. Select **Print & Fax**, **Print & Scan**, or **Printers & Scanners**, select your product, and select **Options & Supplies**. Select **Utility** and select **Open Printer Utility**.
2. Select **Printer and Option Information**.

You see this window:

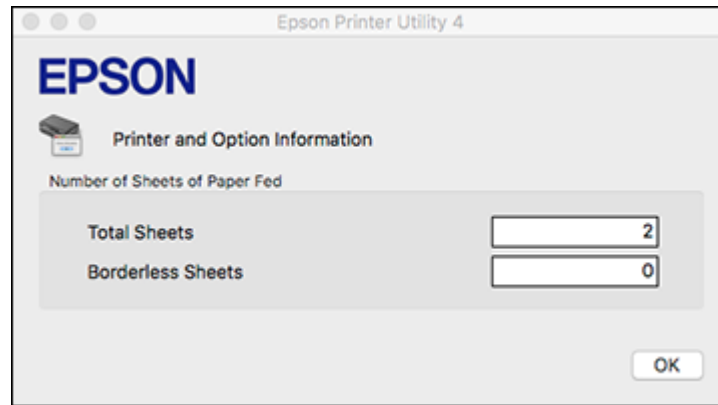

3. After checking the number of sheets fed into the printer, click **OK** to close the window.

**Parent topic:** [Checking the Number of Sheets Fed](#)

---

# Cleaning and Transporting Your Product

See these sections if you need to clean or transport your product.

[Cleaning Your Product](#)

[Transporting Your Product](#)

## Cleaning Your Product

To keep your product working at its best, you should clean it several times a year. Close the output tray, front cover, and rear paper feed cover when you are not using the product to protect it from dust.

**Caution:** Do not use a hard brush, alcohol, or paint thinner to clean the product or you may damage it. Do not use oil or other lubricants inside the product or let water get inside it.

1. Turn off the product.
2. Unplug the power cable.
3. Disconnect any connected cables.
4. Remove all the paper.
5. Clean the scanner glass with a soft, dry cloth. If the glass is stained with grease or some other material, use a small amount of glass cleaner and a soft cloth to remove it. Wipe off all remaining liquid.

**Caution:** Do not press the glass surface with any force. Be careful not to scratch or damage the surface of the glass.

**Caution:** Be careful not to get water onto the printer mechanism or any electrical components. Otherwise, the printer could be damaged.

6. Clean the outer case and control panel with a soft, clean cloth that has been dampened with water. If you cannot remove the dirt, try adding a small amount of mild soap to the damp cloth.

**Parent topic:** [Cleaning and Transporting Your Product](#)

## Transporting Your Product

If you need to store your product or transport it some distance, prepare it for transportation as described here.



**Caution:** During transportation and storage, follow these guidelines:

- When storing or transporting the printer, place the printer in the plastic bag and fold it closed.
- Avoid tilting the product, placing it vertically, or turning it upside down; otherwise ink may leak.

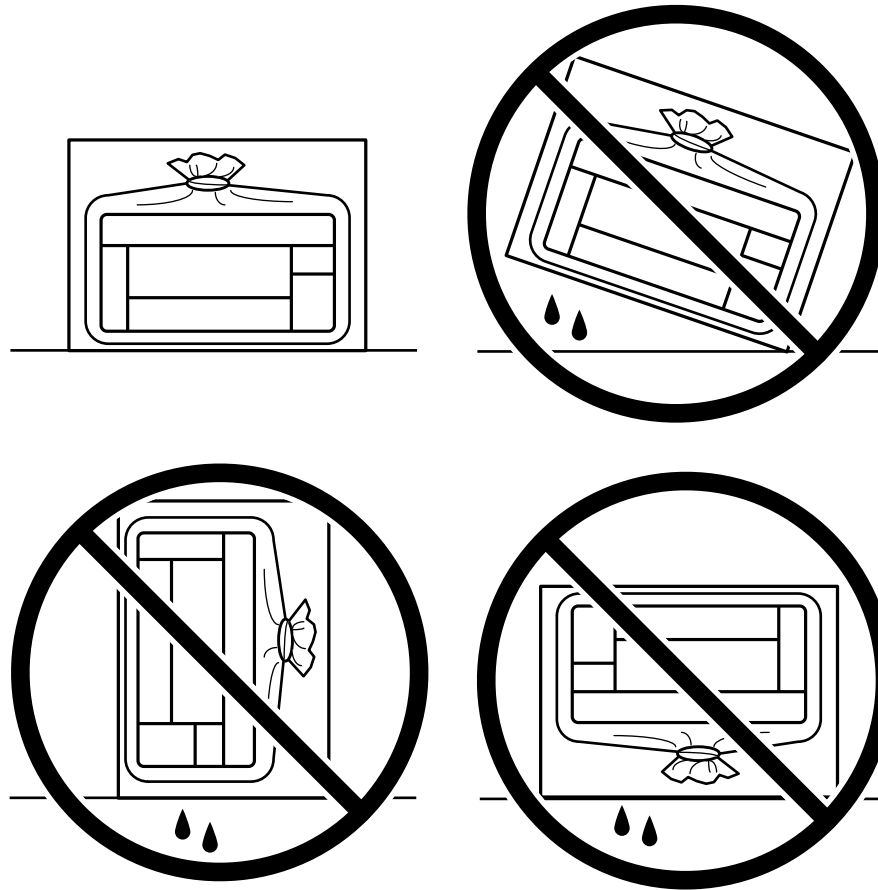

- When storing or transporting an ink bottle after removing its seal, do not tilt the bottle and do not subject it to impacts or temperature changes. Otherwise, ink may leak even if the cap on the ink bottle is tightened securely. Be sure to keep the ink bottle upright when tightening the cap, and take measures to prevent ink from leaking when transporting the ink bottles.

- Do not put opened ink bottles in the box with the product.



**Note:** Before storing your product for a long period, replace low, expended, or expired ink to help prevent the print head from drying out. Store your product in a cool, dry place.

**Note:** Make sure the print head is capped properly to prevent the ink from drying.

1. Turn off the product.
2. Open the front cover and check to see if the print head is in the far right position (the home position). If not, turn on the product, wait for the print head to move to the far right, then turn the product off again.
3. Make sure the power light turns off, and then unplug the power cable.
4. Disconnect any connected cables.
5. Remove all the paper.

6. Open the ink tank cover and make sure that the ink tank caps are securely closed as shown.

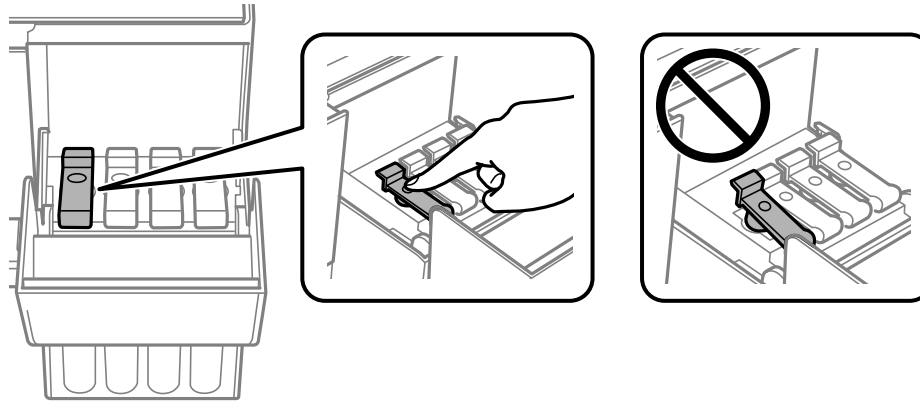

7. Close the ink tank cover.

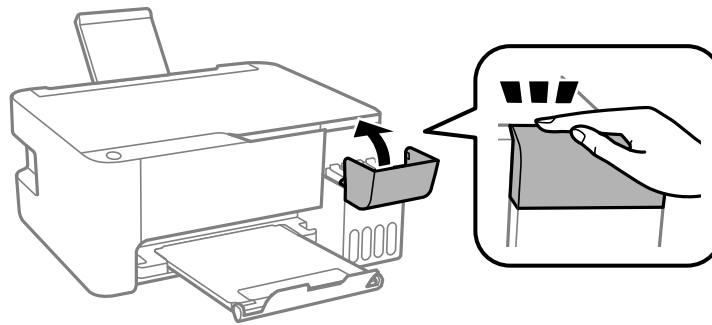

8. Close the paper support, feeder guard, and output tray.

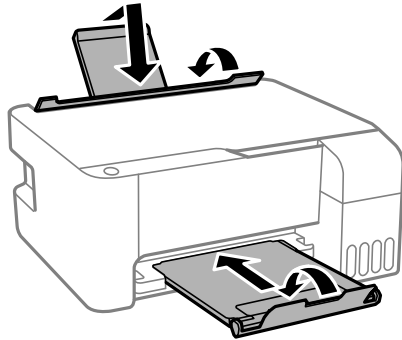

9. Place the printer in the plastic bag and fold it closed. Pack the printer in its box using the protective materials.

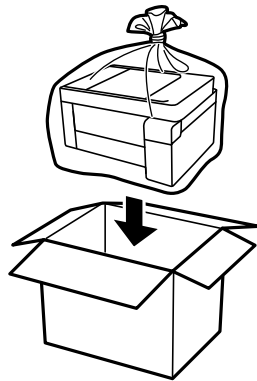

If print quality has declined when you print again, clean and align the print head.

**Parent topic:** [Cleaning and Transporting Your Product](#)

**Related concepts**

[Print Head Cleaning](#)

[Print Head Alignment](#)

---

# Solving Problems

Check these sections for solutions to problems you may have using your product.

[Checking for Software Updates](#)

[Product Light Status](#)

[Running a Product Check](#)

[Resetting Network Settings](#)

[Solving Setup Problems](#)

[Solving Network Problems](#)

[Solving Copying Problems](#)

[Solving Paper Problems](#)

[Solving Problems Printing from a Computer](#)

[Solving Page Layout and Content Problems](#)

[Solving Print Quality Problems](#)

[Solving Scanning Problems](#)



[Solving Scanned Image Quality Problems](#)

[Uninstall Your Product Software](#)

[Where to Get Help](#)

## Checking for Software Updates

It's a good idea to check Epson's support website occasionally for free updates to your product software. Visit [latin.epson.com/support](http://latin.epson.com/support) and select your product.

- **Windows:** Your printer software automatically checks for updates. You can also manually update the software by selecting **Software Update** here:
  - Accessing the Windows Desktop and right-clicking the  icon for your product in the right side of the Windows taskbar, or clicking the up arrow and right-clicking .
  - On the **Maintenance** tab in the printer settings window

You can also update the software by selecting **EPSON Software Updater** in the **EPSON** or **Epson Software** program group, accessible by the **Start** button, or on the **Start** or **Apps** screens, depending on your version of Windows.

- **OS X:** You can manually update the software by opening the **Applications > Epson Software** folder and selecting **EPSON Software Updater**.

- **macOS 10.12.x, 10.13.x, 10.14.x, 10.15.x, or 11.x:** You can manually update the software by opening the **App Store**, selecting **Updates**, searching for a software update option for Epson Software, and selecting **Update**.

**Parent topic:** [Solving Problems](#)

**Related tasks**

[Changing Automatic Update Options](#)





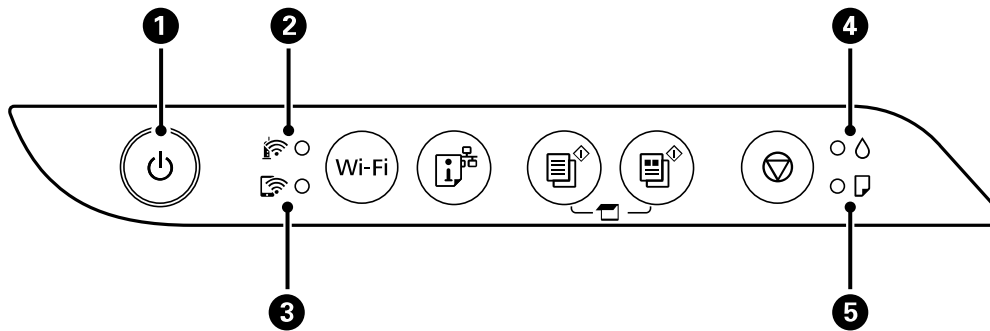



















## Product Light Status

You can often diagnose problems with your product by checking its lights.



- 1    ⏻ power light
- 2    📶 Wi-Fi light
- 3    📶 Wi-Fi Direct light
- 4    💧 ink light
- 5    📄 paper light

| Light status                  | Condition/solution   |
|-------------------------------|--|
| The ⏻ power light is flashing | The product is busy. Wait for the ⏻ power light to stop flashing before turning off the product. |
| The 💧 ink light is on         | Initial ink charging may not be complete. See the <i>Start Here</i> sheet for instructions.      |

| Light status  | Condition/solution   |
|---|--|
| The  paper light is on   | No paper is loaded or multiple sheets fed at one time. Load paper in the product, and press the  B&W copy button or the  color copy button to clear the error.   |
| The  paper light is flashing   | Paper is jammed in the product. Remove the jammed paper, and press the  B&W copy button or the  color copy button to clear the error.  |
| The  ink and  paper lights are flashing simultaneously  | An ink pad is nearing or at the end of its service life. Contact Epson for support. If a message to continue printing appears on your computer, press the  B&W copy button or the  color copy button to continue printing.   |
| The  ink and  paper lights are flashing alternately   | A borderless printing ink pad is nearing or at the end of its service life. Contact Epson for support. If a message to continue printing appears on your computer, press the  B&W copy button or the  color copy button to continue printing. Borderless printing is not available until the ink pad is replaced.            |
| All lights are flashing   | A printer error has occurred. Paper or protective material is stuck inside the product. Open the front cover and remove any jammed paper or protective materials. Turn the product off and then back on again. If the error continues, contact Epson for support.  |
| The  Wi-Fi and  Wi-Fi Direct lights are flashing  | A Wi-Fi connection error has occurred. Press the <b>Wi-Fi</b> button to clear the error and try again.   |
| The  ink light is on<br>The  paper light is on<br>The  Wi-Fi and  Wi-Fi Direct lights are on | An error has occurred during firmware updating. Connect your product using a USB cable and try updating the firmware again. If the error continues, contact Epson for support.   |
| The  ink light is on<br>The  paper light is on  | The product was not turned off correctly. Press the  B&W copy button or the  color copy button to clear the error, then run a nozzle check and cancel any pending print jobs. Always use the  power button to turn off the product. |

**Note:** The ink pads in the printer collect, distribute, and contain the ink that is not used on printed pages. During the life of your product it may reach a condition where either satisfactory print quality cannot be maintained or the ink pads have reached the end of their usable life. The Epson Status Monitor, your LCD screen, or lights on the control panel will advise you when these parts need replacing. If this

happens during the standard warranty of the product, the exchange of the product or replacement of the pads is covered under the standard warranty. If the product is out of warranty, the pads can be replaced by any Epson authorized service provider. The waste ink pads are not a user-replaceable part.

**Parent topic:** [Solving Problems](#)

**Related concepts**

[Print Head Nozzle Check](#)

**Related references**

[Paper Jam Problems](#)

[Where to Get Help](#)

**Related tasks**



[Loading Paper in the Sheet Feeder](#)

**Related topics**

[Wi-Fi Networking](#)

## Running a Product Check

Running a product check helps you determine if your product is operating properly.

1. Press the  power button to turn the product off.
2. Load a few sheets of plain paper in the product.
3. Hold down the  stop button and press the  power button to turn the product on.
4. When the product turns on, release both buttons.

The product prints a nozzle check pattern.

**Note:** It can take a few seconds for the nozzle check to start printing. If the nozzle check does not start printing after a few seconds, make sure there is paper loaded in the printer.



5. Check the printed pattern to see if there are gaps in the lines.

**Print head is clean**

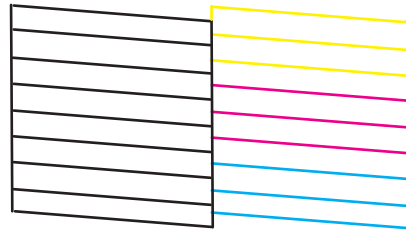

**Print head needs cleaning**

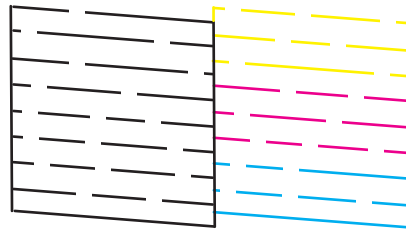

6. Do one of the following, depending on the results of the product check:
  - If the page prints and the nozzle check pattern is complete, the product is operating properly. Any operation problem you may have could be caused by your computer, cable, software, or selected settings. Check the other solutions in this book or try uninstalling and reinstalling your printer software.
  - If the page prints but the nozzle check pattern has gaps, clean or align the print head.
  - If the page prints but almost the entire nozzle check pattern is missing, perform a Power Cleaning.
  - If the page does not print, the product may have a problem. Check the other solutions in this manual. If they do not work, contact Epson.

**Parent topic:** [Solving Problems](#)

**Related concepts**

[Print Head Cleaning](#)

[Print Head Alignment](#)

[Uninstall Your Product Software](#)





[Power Cleaning](#)

**Related references**

[Where to Get Help](#)

## Resetting Network Settings

You can reset the network settings to their factory defaults.

1. Turn off your product.
2. Hold down the  network status button and press the  power button until the  Wi-Fi light and  Wi-Fi Direct light flash alternately. Then release both buttons.

When the  Wi-Fi light and  Wi-Fi Direct light turn off, the Wi-Fi settings are reset.

**Parent topic:** [Solving Problems](#)

## Solving Setup Problems

Check these sections if you have problems while setting up your product.

[Product Does Not Turn On or Off](#)

[Noise After Filling the Ink](#)

[Software Installation Problems](#)

**Parent topic:** [Solving Problems](#)

## Product Does Not Turn On or Off

If you cannot turn the product on or off, try these solutions:

- If you cannot turn on your product, make sure the power cord is securely connected and hold down the power button a little longer.
- If you cannot turn off your product, hold down the power button a little longer. If you still cannot turn off your product, unplug the power cord, plug the power cord back in, then turn your product on and off again using the power button.

**Parent topic:** [Solving Setup Problems](#)

## Noise After Filling the Ink

If you hear noises from your product after filling the ink tanks with ink, check these explanations:

- The first time you fill the tanks with ink, the product must charge its print head. Wait until charging finishes before you turn off the product, or it may charge improperly and use excess ink the next time you turn it on. Your product is finished charging the print head when the ⏻ power light stops flashing.
- If the product's ⏻ ink light is on, the charging process may not be complete. Wait until charging finishes before you turn off the product, or it may charge improperly and use excess ink the next time you turn it on.
- If the product's print head stops moving or making noise, and the charging process has not finished after approximately 20 minutes, turn off your product. Turn it back on and check to see if charging is still in progress. If it is still in progress, contact Epson for help.

**Parent topic:** [Solving Setup Problems](#)

### Related topics

[Refilling Ink](#)

## Software Installation Problems

If you have problems while installing your product software, try these solutions:

- Make sure your product is turned on and any necessary cables are securely connected at both ends. If you still have problems installing software, disconnect the cable and carefully follow the instructions on the *Start Here* sheet. Also make sure your system meets the requirements for your operating system.
- Close any other programs, including screen savers and virus protection software, and install your product software again.
- In Windows, make sure your product is selected as the default printer and the correct port is shown in the printer properties.
- If you see any error message or your software does not install correctly in Windows, you may not have software installation privileges. Contact your system administrator.
- If you are printing over a network, make sure your product is set up properly on the network.
- If the USB cable is not recognized, try using a different USB cable.

**Parent topic:** [Solving Setup Problems](#)

### Related concepts

[Uninstall Your Product Software](#)

### Related references

[Windows System Requirements](#)

[Mac System Requirements](#)

## Solving Network Problems

Check these solutions if you have problems setting up or using your product on a network.

**Note:** Breakdown or repair of this product may cause loss of network data and settings. Epson is not responsible for backing up or recovering data and settings during or after the warranty period. We recommend that you make your own backup or print out your network data and settings.

[Product Cannot Connect to a Wireless Router or Access Point](#)

[Network Software Cannot Find Product on a Network](#)

[Product Does Not Appear in Mac Printer Window](#)

[Wireless Network Connection is Unstable on a Mac](#)

[Cannot Print Over a Network](#)

[Cannot Scan Over a Network](#)

**Parent topic:** [Solving Problems](#)

### Product Cannot Connect to a Wireless Router or Access Point

If your product has trouble finding or connecting to a wireless router or access point, try these solutions:

- If you are connecting the product via Wi-Fi Protected Setup (WPS) and the  Wi-Fi light on your product is not solid green, make sure you press the **Wi-Fi** button on the product within 2 minutes of pressing the WPS button on your router. Hold down the **Wi-Fi** button on the product for 3 seconds.
- Make sure to place your product within contact range of your 2.4 GHz router or access point. Avoid placing your product near a microwave oven, 2.4 GHz cordless phone, or large metal object, such as a filing cabinet.

**Note:** If you are using a 5 GHz wireless router, set the router to operate in dual band (2.4 GHz and 5 GHz) mode. If your router uses a single network name (SSID) for both the 2.4 GHz and 5 GHz band, give each band its own network name (SSID) instead, such as Home Network 2.4 GHz and Home Network 5 GHz. See your router documentation or contact your internet service provider for instructions.

- Verify that your router or access point is operating correctly by connecting to it from your computer or another device.

- Print a network connection report and check the codes and messages on the report to help determine the cause of the problem.
- You may need to disable the firewall and any anti-virus software on your wireless router or access point.
- Try restarting your router following the instructions in your router documentation.

**Note:** If you are reading these instructions online, you will lose your Internet connection when you restart your router.

- Check to see if access restrictions, such as MAC address filtering, are set on the router or access point. If access restrictions are set, add your product's MAC address to your router's address list. Then follow the instructions in your router or access point documentation to add the address to the list.
- If your router or access point does not broadcast its network name (SSID), follow the instructions that came with your product to enter your wireless network name manually.
- If your router or access point has security enabled, determine the kind of security it is using and any required password or passphrase for connection. Then make sure to enter the exact WEP key or WPA passphrase correctly.
- Check if your computer is restricting the available wireless channels. If so, verify that your wireless access point is using one of the usable channels and change to a usable channel, if necessary.
- Turn off the devices you want to connect to the network. Wait for about 10 seconds and then turn on the devices in the following order: wireless router, computer or smart device, and then your product. Move your product and computer or smart device closer to the wireless router to help with radio wave communication, and then try to make network settings again.
- If the IP address assigned to the product is 169.254.XXX.XXX and the subnet mask is 255.255.0.0, the IP address may not be assigned correctly. Check the IP address and the subnet mask assigned to the product. Restart the wireless router or reset the network settings for the product.
- If you are using a Wi-Fi Direct connection that suddenly disconnects, the Wi-Fi direct password on your device may have been changed. If necessary, delete the existing **DIRECT-xxxxxxx** connection settings from your device and enter a new password. See your device documentation for instructions.
- If you connected your product to a Windows computer using Wi-Fi Direct and it automatically selected Access Point Mode, you may have trouble accessing a low-priority Internet connection. Check the network connection or adapter settings in the Windows Control Panel and set the **Internet metric** setting to **100** for your version of the Internet Protocol.

**Parent topic:** [Solving Network Problems](#)

### Related tasks

[Enabling Wi-Fi Direct Mode](#)

[Using WPS to Connect to a Network](#)

[Printing a Network Status Sheet](#)

[Resetting Network Settings](#)

## Network Software Cannot Find Product on a Network

If EpsonNet Setup cannot find your product on a network, try these solutions:

- Make sure your product is turned on and connected to your network. Verify the connection using your product control panel.
- Check if your network name (SSID) contains non-ASCII characters. Your product cannot display non-ASCII characters.
- Print a network connection report and check the codes and messages on the report to help determine the cause of the problem.
- Make sure your product is not connected to a guest network.
- If necessary, reinstall your product software and try running EpsonNet Setup again:
  1. Reset your product's network settings to their factory defaults.
  2. **Windows only:** Uninstall your product software.
  3. Restart your router following the instructions in your router documentation.

**Note:** If you are reading these instructions online, you will lose your Internet connection when you restart your router, so note the next step before restarting it.

4. Download your product software from the Epson website using the instructions on the *Start Here* sheet.
- If you have replaced your router, reinstall your product software to connect to the new router.

**Note:** If you are using a 5 GHz wireless router, set the router to operate in dual band (2.4 GHz and 5 GHz) mode. If your router uses a single network name (SSID) for both the 2.4 GHz and 5 GHz band, give each band its own network name (SSID) instead, such as Home Network 2.4 GHz and Home Network 5 GHz. See your router documentation or contact your internet service provider for instructions.

- Check to see if your wireless router or access point has an enabled Privacy Separator function that is preventing detection of your device over the network. See your router or access point documentation for instructions on disabling the Privacy Separator function.
- Try accessing any website from your computer to make sure that your computer's network settings are correct. If you cannot access any website, there is a problem on the computer. Check the network connection of the computer. See the documentation provided with the computer for details.

**Parent topic:** [Solving Network Problems](#)

**Related concepts**

[Uninstall Your Product Software](#)

**Related tasks**

[Enabling Wi-Fi Direct Mode](#)

[Using WPS to Connect to a Network](#)



[Printing a Network Status Sheet](#)

[Resetting Network Settings](#)

[Connecting to a New Wi-Fi Router](#)

## Product Does Not Appear in Mac Printer Window

If your product does not appear in the Mac printer window, try these solutions:

- Turn your product off, wait 30 seconds, then turn it back on again.
- If you are connecting the product via Wi-Fi Protected Setup (WPS) and the  Wi-Fi light on your product is not solid green, make sure you press the **Wi-Fi** button on the product within 2 minutes of pressing the WPS button on your router. Hold down the **Wi-Fi** button on the product for 3 seconds.
- If you are connecting the product wirelessly via EpsonNet Setup and the  Wi-Fi light on your product is not solid green, make sure your product software was installed correctly. If necessary, reinstall your software.

**Note:** If you are using a 5 GHz wireless router, set the router to operate in dual band (2.4 GHz and 5 GHz) mode. If your router uses a single network name (SSID) for both the 2.4 GHz and 5 GHz band, give each band its own network name (SSID) instead, such as Home Network 2.4 GHz and Home Network 5 GHz. See your router documentation or contact your internet service provider for instructions.

**Parent topic:** [Solving Network Problems](#)

**Related concepts**

[Uninstall Your Product Software](#)

### Related tasks

[Enabling Wi-Fi Direct Mode](#)

[Using WPS to Connect to a Network](#)

## Wireless Network Connection is Unstable on a Mac

If you connected a device to a USB 3.0 port on your Mac, you may experience wireless network interference between your product and your Mac.

If you cannot connect to your product over the wireless network or the connection becomes unstable, move the device connected to your Mac USB 3.0 port further away from your Mac.

**Parent topic:** [Solving Network Problems](#)

## Cannot Print Over a Network

If you cannot print over a network, try these solutions:

- Make sure that your product is turned on.
- Make sure you install your product's network software as described in your product documentation.
- Make sure that the latest version of your product's Epson printer driver is installed. If a genuine Epson printer driver is not installed, the available functions are limited.
- Print a network status sheet and verify that the network settings are correct. If the network status is **Disconnected**, check any cable connections and turn your product off and then on again.
- Print a network connection report and check the codes and messages on the report to help determine the cause of the problem.
- If you are using TCP/IP, make sure the product's IP address is set correctly for your network. If your network does not assign IP addresses using DHCP, set the IP address manually.
- Make sure your computer and product are both using the same wireless network.
- If network printing is slow, print a network status sheet and check the signal strength. If it is poor, place your product closer to your router or access point. Avoid placing your product near a microwave oven, cordless phone, or large metal object, such as a filing cabinet.

**Note:** If you are using a 5 GHz wireless router, set the router to operate in dual band (2.4 GHz and 5 GHz) mode. If your router uses a single network name (SSID) for both the 2.4 GHz and 5 GHz band, give each band its own network name (SSID) instead, such as Home Network 2.4 GHz and Home Network 5 GHz. See your router documentation or contact your internet service provider for instructions.



- Try restarting your router following the instructions in your router documentation.

**Note:** If you are reading these instructions online, you will lose your Internet connection when you restart your router.

- Check to see if your wireless router or access point has an enabled Privacy Separator function that is preventing printing from a device over the network. See your router or access point documentation for instructions on disabling the Privacy Separator function.
- If you are connecting the product via Wi-Fi Protected Setup (WPS) and the  Wi-Fi light on your product is not solid green, make sure you press the **Wi-Fi** button on the product within 2 minutes of pressing the WPS button on your router. Hold down the **Wi-Fi** button on the product for 3 seconds.
- If you are printing a large data size image, the computer may run out of memory. Print the image at a lower resolution or a smaller size.

**Parent topic:** [Solving Network Problems](#)

#### **Related concepts**

[Uninstall Your Product Software](#)

#### **Related tasks**

[Enabling Wi-Fi Direct Mode](#)

[Using WPS to Connect to a Network](#)

[Printing a Network Status Sheet](#)

## **Cannot Scan Over a Network**

If you have problems scanning over a network, try these solutions:

- Make sure you are scanning from a computer. If you want to scan from your product control panel, you must connect the product to your computer with a USB cable.
- Check the scanning setting assigned in Epson Event Manager.
- If you are scanning a large original at a high resolution, a network communication error may occur. Try scanning again at a lower resolution.
- If network communication was interrupted while starting Epson Scan 2, exit Epson Scan 2, wait a few seconds, and restart it. If Epson Scan 2 cannot restart, turn off your product, turn it back on, and try restarting Epson Scan 2 again.
- Check the scanner setting and reset the connection if necessary using Epson Scan 2 Utility:

**Windows 10:** Click  and select **EPSON > Epson Scan 2 Utility**. Make sure your product is selected. If necessary, select the **Other** tab and click **Reset**.

**Windows 8.x:** Navigate to the **Apps** screen, select **EPSON**, and select **Epson Scan 2 Utility**. Make sure your product is selected. If necessary, select the **Other** tab and click **Reset**.

**Windows (other versions):** Click  or **Start > All Programs** or **Programs > EPSON > Epson Scan 2 > Epson Scan 2 Utility**. Make sure your product is selected. If necessary, select the **Other** tab and click **Reset**.

**Mac:** Open the **Applications** folder, click **Epson Software**, and click **Epson Scan 2 Utility**. Make sure your product is selected. If necessary, select the **Other** tab and click **Reset**.

- You may need to disable the firewall and any anti-virus software on your wireless router or access point.

**Parent topic:** [Solving Network Problems](#)

**Related topics**

[Wi-Fi Networking](#)

[Starting a Scan](#)

## Solving Copying Problems

Check these solutions if you have problems copying with your product.

[Product Makes Noise, But Nothing Copies](#)

[Product Makes Noise When It Sits for a While](#)

[Copies are Cut Off](#)

[Copies Have Incorrect or Faint Colors](#)

[Position, Size, or Margins of Copies are Incorrect](#)

**Parent topic:** [Solving Problems](#)

## Product Makes Noise, But Nothing Copies

If your product makes a noise, but nothing copies, try these solutions:

- Run a nozzle check to see if any of the print head nozzles are clogged. Then clean the print head, if necessary.
- If the nozzle check page does not print, but the product's power is on, make sure your product software is installed correctly.
- Make sure your product is level (not tilted).

**Parent topic:** [Solving Copying Problems](#)

### Related concepts

[Print Head Nozzle Check](#)

[Print Head Cleaning](#)





## Product Makes Noise When It Sits for a While

Your product is performing routine maintenance. This is normal.

**Parent topic:** [Solving Copying Problems](#)

## Copies are Cut Off

Depending on your product, the default paper size for copies is either A4 (8.3 × 11.7 inches [210 × 297 mm]) or Letter (8.5 × 11 inches [216 × 279 mm]).

- To change the default paper size to A4 (8.3 × 11.7 inches [210 × 297 mm]), make sure the product is turned off, then hold down the  color copy button and press the  power button to turn the product on. When the product turns on, release both buttons.
- To change the default paper size to Letter (8.5 × 11 inches [216 × 279 mm]), make sure the product is turned off, then hold down the  B&W copy button and press the  power button to turn the product on. When the product turns on, release both buttons.

**Parent topic:** [Solving Copying Problems](#)

## Copies Have Incorrect or Faint Colors

If your copies have incorrect, uneven, smeared, or faint colors, try these solutions:

- Run a print head nozzle check to see if any of the nozzles are clogged. Then clean the print head, if necessary.
- Do not press too hard on the original when you copy from the scanner glass.
- Clean the scanner glass with a soft, dry, lint-free cloth or use a small amount of glass cleaner on the cloth, if necessary. Paper towels are not recommended.

**Caution:** Do not spray glass cleaner directly on the scanner glass.

- Wipe any dirt or dust off of your originals.
- Make sure your paper is not curled.
- When vertical banding appears or the paper is smeared, clean the paper path.

- When horizontal banding appears or the top or bottom of the paper is smeared, load paper in the correct direction and slide the edge guides to the edges of the paper.

**Parent topic:** [Solving Copying Problems](#)

## **Position, Size, or Margins of Copies are Incorrect**

If the position, size, or margins of your copies are incorrect, try these solutions:

- When placing originals on the scanner glass, make sure the original is placed correctly for scanning. Align the corner of the original with the corner indicated by the symbol on the scanner glass. If necessary, move the original away from the edges of the scanner glass slightly.
- Make sure the paper is loaded in the correct direction.

**Parent topic:** [Solving Copying Problems](#)

## **Solving Paper Problems**

Check these sections if you have problems using paper with your product.

[Paper Feeding Problems](#)

[Paper Jam Problems](#)

[Paper Ejection Problems](#)

**Parent topic:** [Solving Problems](#)

## **Paper Feeding Problems**

If you have problems feeding paper, try these solutions:

- Place the product on a flat surface.
- If paper does not feed for printing, remove it. Then reload it in the middle of the rear paper feed. Slide the edge guide against the edge of the paper, making sure that the paper stack is not above the arrow mark on the edge guide.
- If multiple pages feed at once, remove the paper, fan the edges to separate the sheets, and reload it.
- If multiple pages feed at once during manual 2-sided printing, remove any paper from the product before reloading paper.
- If paper jams when you load only one or two sheets, try loading more sheets at a time. Do not load more than the recommended number of sheets.
- Do not load more than the recommended number of sheets.
- If paper jams when you print on both sides of the paper, try loading fewer sheets.

- Make sure your paper meets the specifications for your product.
- Try cleaning the paper path.
- Do not place objects on the feeder guard.
- For best results, follow these guidelines:
  - Use new, smooth, high-quality paper that is not curled, creased, old, too thin, or too thick.
  - Load paper in the rear paper feed printable side up.
  - Follow any special loading instructions that came with the paper.

**Parent topic:** [Solving Paper Problems](#)

**Related references**

[Paper Loading Capacity](#)

[Paper Jam Problems](#)

**Related tasks**

[Loading Paper in the Sheet Feeder](#)

## Paper Jam Problems

If you have problems with paper jams, try these solutions:

1. Cancel the print job from your computer, if necessary.
2. Gently pull out any jammed paper from the rear paper feed slot.

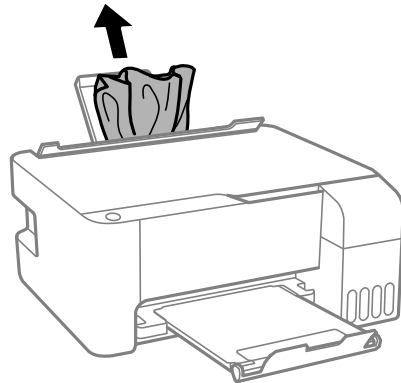

3. Open the front cover.

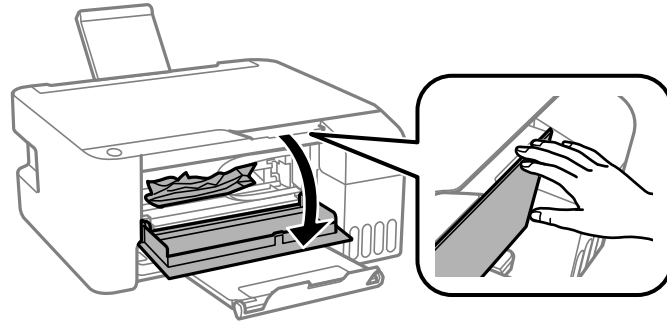

4. Open the scanner unit until it clicks.

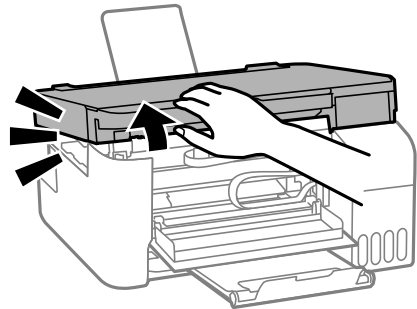

**Caution:** Do not touch the parts shown here or you may damage the product.

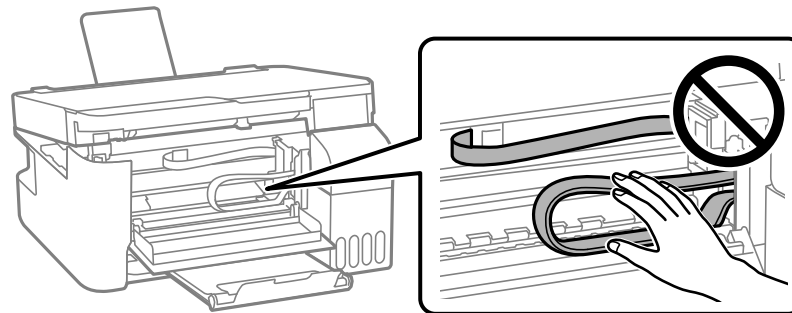

**Caution:** Never touch the buttons on the control panel while your hand is inside the printer. If the printer starts operating, it could cause an injury. Be careful not to touch the protruding parts to avoid injury.

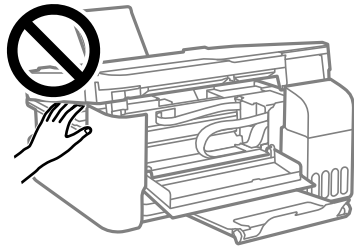
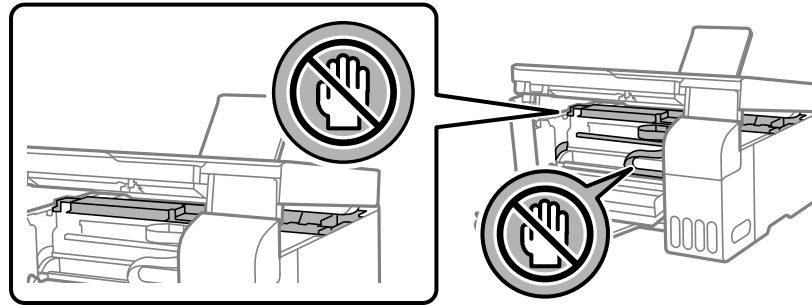

5. Gently remove any jammed paper.

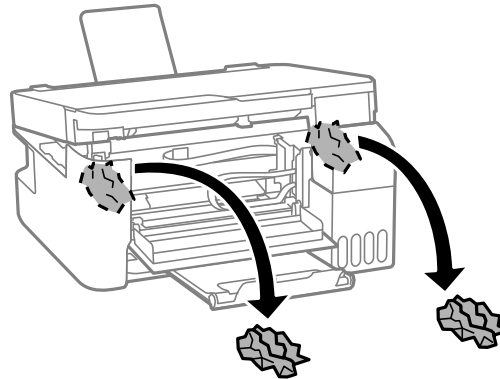
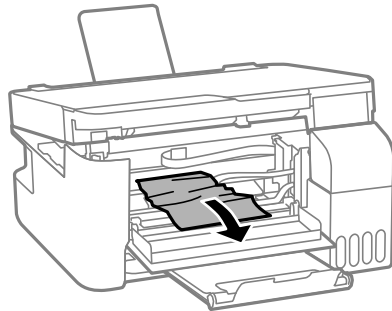

**Caution:** When removing jammed paper, avoid tilting the printer, placing it vertically, or turning it upside down; otherwise ink may leak.

6. Close the scanner unit.

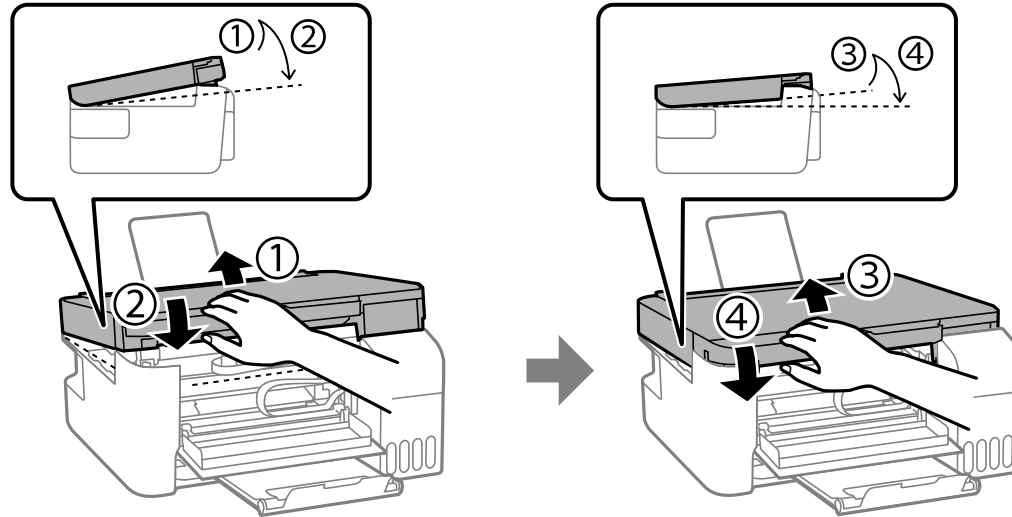

7. Close the front cover.

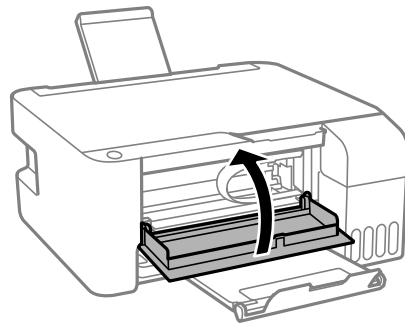

8. Carefully follow all paper loading instructions when you load new paper.

**Parent topic:** [Solving Paper Problems](#)



**Related tasks**

[Cancelling Printing Using a Product Button](#)  
[Loading Paper in the Sheet Feeder](#)

**Paper Ejection Problems**

If you have problems with paper ejecting properly, try these solutions:

- If paper does not eject fully, you may have set the wrong paper size. Cancel printing to eject the paper. Select the correct paper size when you reprint.
- If paper is wrinkled when it ejects, it may be damp or too thin. Load new paper and be sure to select the correct paper type setting when you reprint.

**Parent topic:** [Solving Paper Problems](#)

**Related references**

[Paper or Media Type Settings](#)

**Related tasks**

[Cancelling Printing Using a Product Button](#)  
[Loading Paper in the Sheet Feeder](#)

**Solving Problems Printing from a Computer**

Check these sections if you have problems while printing from your computer.

[Nothing Prints](#)

[Product Icon Does Not Appear in Windows Taskbar](#)



[Printing is Slow](#)

**Parent topic:** [Solving Problems](#)

**Nothing Prints**

If you have sent a print job and nothing prints, try these solutions:

- Make sure your product is turned on and connected to your computer.
- Make sure any interface cables are connected securely at both ends.
- If you connected your product to a USB hub, make sure it is a first-tier hub. If it still does not print, connect your product directly to your computer instead of the hub.
- If your computer is connected using a USB cable, try a different USB port on your computer or a different cable.

- Make sure the printer status is not offline or pending.
- Make sure you are using the Epson printer driver for your product or the available functions are limited.
- Run a product check to see if a test page prints. If the test page prints, check to see if your product software is installed correctly.
- Make sure your system meets the requirements for your operating system. If you are printing a high-resolution image, you may need more than the minimum requirements. Print the image at a lower resolution or if necessary, increase your system's memory.
- In Windows, make sure your product is selected as the default printer and the printer port setting matches the printer connection port.
- In Windows, delete all jobs from the Windows Spooler. Click **Print Queue** on the Maintenance tab in the printer settings window, and cancel any stalled print jobs.
- In Windows, do one of the following to open the Epson Printer Connection Checker and follow the on-screen instructions to check the connection status:
  - **Windows 10:** Click  and select **Epson Software > Epson Printer Connection Checker**.
  - **Windows 8.x:** Navigate to the **Apps** screen and select the **Epson Printer Connection Checker** icon.
  - **Windows 7:** Click  and select **All Programs > Epson Software > Epson Printer Connection Checker**.
- On a Mac, make sure the printer is added to the printer list and the printer is not paused.
- Make sure your product is selected as the printer in your printing program.

**Parent topic:** [Solving Problems Printing from a Computer](#)



#### **Related tasks**



[Running a Product Check](#)

## **Product Icon Does Not Appear in Windows Taskbar**

If you do not see your product icon in the Windows taskbar, first try restarting your computer. If that does not work, try this solution:

1. Do one of the following:

- **Windows 10:** Click  and select  (Settings) > **Devices > Printers & scanners**. Select your product name and select **Manage > Printing preferences**.

- **Windows 8.x:** Navigate to the **Apps** screen and select **Control Panel > Hardware and Sound > Devices and Printers**. Right-click your product name, select **Printing Preferences**, and select your product name again if necessary.
  - **Windows 7:** Click  and select **Devices and Printers**. Right-click your product name, select **Printing Preferences**, and select your product name again if necessary.
  - **Windows Vista:** Click , select **Control Panel**, and click **Printer** under **Hardware and Sound**. Right-click your product name, select **Printing Preferences**, and select your product name again if necessary.
2. Click the **Maintenance** tab.
  3. Click the **Extended Settings** button.
  4. Select **Enable EPSON Status Monitor 3** and click **OK**.
  5. Click the **Monitoring Preferences** button.
  6. Click the checkbox for the option that adds the shortcut icon to the taskbar.
  7. Click **OK** to close the open program windows.

**Parent topic:** [Solving Problems Printing from a Computer](#)

## Printing is Slow

If printing becomes slow, try these solutions:

- Make sure your system meets the requirements for your operating system. If you are printing a high-resolution image, you may need more than the minimum requirements. If necessary, increase your system's memory.
- If you are using Windows 7, close the **Devices and Printers** window before you print.
- On a Mac, make sure you download and install the Epson printer driver.
- Make sure **Quiet Mode** is turned off.
- Clear space on your hard drive or run a defragmentation utility to free up existing space.
- Close any programs you are not using when you print.
- If your product is connected to a USB hub, connect it directly to your computer instead.
- If printing becomes slower after printing continuously for a long time, the product may have automatically slowed down to protect the print mechanism from overheating or becoming damaged. Let the product rest with the power on for 30 minutes, then try printing again.

- If you are printing over a wireless network, factors such as interference, network traffic, or weak signal strength may affect your printing speed.

**Note:** If you are using a 5 GHz wireless router, set the router to operate in dual band (2.4 GHz and 5 GHz) mode. If your router uses a single network name (SSID) for both the 2.4 GHz and 5 GHz band, give each band its own network name (SSID) instead, such as Home Network 2.4 GHz and Home Network 5 GHz. See your router documentation or contact your internet service provider for instructions.

For the fastest printing, select the following settings in your product software:

- Make sure the paper type setting matches the type of paper you loaded.
- Turn on any high speed settings in your product software.
- Select a lower print quality setting.
- **Windows:** Click the **Maintenance** or **Utility** tab, select **Extended Settings** or **Speed and Progress**, and select the following settings:
  - **Always Spool RAW Datatype**
  - **Page Rendering Mode**
  - **Print as Bitmap**
- **Windows:** Select **Printing preferences**, click the **More Options** tab, and make sure the **Bidirectional printing** setting is enabled.
- **Mac:** Select **System Preferences**, select **Printers & Scanners**, and select your product. Select **Options & Supplies**, select **Options** (or **Driver**), and enable the **Bidirectional printing** setting.

If printing is still slow and you are using Windows 7 or Windows Vista, try the following:

1. Click  and select **Computer** or **My Computer**. Double-click the **C:** drive and open these folders: **ProgramData > EPSON > PRINTER**.

**Note:** If you do not see the ProgramData folder, open the **Organize** menu and select **Folder and search options**. In the window that appears, click the **View** tab, select **Show hidden files, folders, and drives** in the Advanced settings list, and click **OK**.

2. Right-click the **EPAUDF01.AUD** file and select **Delete**.
3. Restart your computer and try printing again.

**Parent topic:** [Solving Problems Printing from a Computer](#)

**Related references**

[Windows System Requirements](#)

[Mac System Requirements](#)

[Paper or Media Type Settings](#)

**Related tasks**

[Selecting Basic Print Settings - Windows](#)

[Selecting Extended Settings - Windows](#)

[Selecting Basic Print Settings - Mac](#)

[Selecting Printing Preferences - Mac](#)

## Solving Page Layout and Content Problems

Check these sections if you have problems with the layout or content of your printed pages.

[Inverted Image](#)

[Too Many Copies Print](#)

[Blank Pages Print](#)

[Incorrect Margins on Printout](#)

[Border Appears on Borderless Prints](#)

[Incorrect Characters Print](#)

[Incorrect Image Size or Position](#)

[Slanted Printout](#)

**Parent topic:** [Solving Problems](#)

### Inverted Image

If your printed image is inverted unexpectedly, try these solutions:

- Turn off any mirror or inversion settings in your printing application.
- Turn off the **Mirror Image**, **Flip horizontally**, or **Reverse page orientation** settings in your printer software. (This option has different names, depending on your operating system version.)

**Parent topic:** [Solving Page Layout and Content Problems](#)

**Related tasks**

[Selecting Additional Layout and Print Options - Windows](#)

[Selecting Print Layout Options - Mac](#)

## Too Many Copies Print

Make sure that the **Copies** setting in your printing program or printer software is not set for multiple copies.

**Parent topic:** [Solving Page Layout and Content Problems](#)

## Blank Pages Print

If blank pages print unexpectedly, try these solutions:

- Make sure you selected the correct paper size settings in your printing program and printer software.
- If a blank page exists in a document you are printing and you want to skip printing it, select the **Skip Blank Page** setting in your printer software, if available.
- Run a print head nozzle check to see if any of the nozzles are clogged. Then clean the print head, if necessary.
- Make sure your product is selected as the printer in your printing program.
- You may need to refill the ink. Visually check the ink levels.

**Parent topic:** [Solving Page Layout and Content Problems](#)

### Related concepts

[Print Head Nozzle Check](#)

[Print Head Cleaning](#)

### Related references

[Paper or Media Type Settings](#)

### Related tasks

[Checking Ink Levels on Your Product](#)

[Selecting Basic Print Settings - Windows](#)

[Selecting Extended Settings - Windows](#)

[Selecting Basic Print Settings - Mac](#)

[Selecting Printing Preferences - Mac](#)

## Incorrect Margins on Printout

If your printed page has incorrect margins, try these solutions:

- Make sure you selected the correct paper size settings in your printing program and printer software.
- Make sure you selected the correct margins for your paper size in your printing program.

- Make sure your paper is positioned correctly for feeding into the product.
- When placing originals on the scanner glass, align the corner of the original with the corner indicated by the arrow. If the edges of the copy are cropped, move the original slightly away from the corner.
- Clean the scanner glass and the document cover. If there is dust or stains on the glass, the copy area may extend to include the dust or stains.
- Load paper in the correct direction and slide the edge guides against the edges of the paper.

You can use the preview option in your printer software to check your margins before you print.

**Parent topic:** [Solving Page Layout and Content Problems](#)

**Related references**

[Paper or Media Type Settings](#)

**Related tasks**

[Selecting Basic Print Settings - Windows](#)

[Selecting Basic Print Settings - Mac](#)

**Related topics**

[Loading Paper](#)

## Border Appears on Borderless Prints

If you see a border on borderless prints, try these solutions:

- Make sure you are printing on a compatible borderless paper type and size.
- **Windows:** Make sure you selected the **Borderless** setting in your printer software.
- **Mac:** Make sure you selected the **Borderless** checkbox or a paper size with a **Borderless** option in your printer software.
- Adjust the **Expansion** setting to adjust the amount of image expansion on the edges of borderless prints.
- Make sure the image size and the paper size are set correctly; if the image is small, the enlargement may not be enough to cover the paper.
- Access the Extended Settings (Windows) or Printing Preferences (Mac) and select **Remove White Borders**.

**Parent topic:** [Solving Page Layout and Content Problems](#)

**Related references**

[Paper or Media Type Settings](#)

[Print Options - Mac](#)

**Related tasks**

[Selecting Basic Print Settings - Windows](#)

[Selecting Extended Settings - Windows](#)

[Selecting Basic Print Settings - Mac](#)

[Selecting Printing Preferences - Mac](#)

## **Incorrect Characters Print**

If incorrect characters appear in your prints, try these solutions before reprinting:

- Make sure any cables are securely connected at both ends.
- In Windows, delete all jobs from the Windows Spooler. Click **Print Queue** on the Maintenance tab in the printer settings window, and cancel any stalled print jobs.
- If your product is connected to a USB hub, connect it directly to your computer instead.
- If incorrect characters still appear in your prints, try connecting your product using a different cable.
- If your computer entered sleep mode the last time you printed, the next print job after your computer exits sleep mode may contain garbled characters. Print your document again.
- Make sure you are using the printer software for this product. Check the product name at the top of the driver window.

**Parent topic:** [Solving Page Layout and Content Problems](#)

**Related tasks**

[Selecting Basic Print Settings - Windows](#)

[Selecting Extended Settings - Windows](#)

## **Incorrect Image Size or Position**

If your printed image is the wrong size or in the wrong position, try these solutions:

- Make sure you selected the correct paper size and layout settings in your printing program and printer software.
- Make sure your paper is positioned correctly for feeding into the printer.
- Slide the edge guides against the edges of the paper.
- Clean the scanner glass and document cover.
- If the edges of a copy are cropped, slightly move the original away from the edges of the scanner glass.



- Make sure you selected the correct margins for your paper size in your printing program.
- If the image is slightly enlarged and cropped during borderless printing, change the **Expansion** setting.

You can use the preview option in your printer software to check your margins before you print.

**Parent topic:** [Solving Page Layout and Content Problems](#)

**Related references**

[Paper or Media Type Settings](#)

**Related tasks**

[Selecting Basic Print Settings - Windows](#)

[Selecting Basic Print Settings - Mac](#)

[Placing Originals on the Scanner Glass](#)

**Related topics**

[Loading Paper](#)

## Slanted Printout

If your printouts are slanted, try these solutions:

- Make sure your paper meets the specifications for your product.
- Do not load more than the recommended number of sheets.
- Slide the edge guides against the edges of the paper.
- Select a higher print quality setting in your printer software.
- Turn off any high speed settings in your product software.
- Align the print head.
- Adjust the print quality.
- Make sure the product is not printing while tilted or at an angle.

**Parent topic:** [Solving Page Layout and Content Problems](#)

**Related tasks**

[Selecting Basic Print Settings - Windows](#)

[Selecting Basic Print Settings - Mac](#)

**Related topics**

[Loading Paper](#)

## Solving Print Quality Problems

Check these sections if your printouts have problems with print quality, but your image looks fine on your computer screen.

[White or Dark Lines in Printout](#)

[Blurry or Smearred Printout](#)

[Faint Printout or Printout Has Gaps](#)

[Grainy Printout](#)

[Incorrect Colors](#)

**Parent topic:** [Solving Problems](#)

### White or Dark Lines in Printout

If you notice white or dark lines in your prints (also called banding), try these solutions before you reprint:

- Run a nozzle check to see if any of the print head nozzles are clogged. Then clean the print head, if necessary.
- Make sure the paper type setting matches the type of paper you loaded.
- Make sure you loaded the printable side of the paper correctly for your product.
- Turn off any high speed settings in your product software.
- Align the print head. If print quality does not improve after aligning the print head, disable the bidirectional (high speed) setting.
- Adjust the print quality in the product software.
- When horizontal banding appears or the top or bottom of the paper is smeared, load paper in the correct direction and slide the edge guides to the edges of the paper.
- When vertical banding appears or the paper is smeared, clean the paper path.
- You may need to refill the ink. Visually check the ink levels.
- If you have not used the product for a long time, run the Power Cleaning utility.

**Note:** Power Cleaning consumes a lot of ink, so run this utility only if you cannot improve print quality by cleaning the print head.

**Parent topic:** [Solving Print Quality Problems](#)

**Related concepts**

[Print Head Nozzle Check](#)

[Print Head Cleaning](#)  
[Print Head Alignment](#)  
[Power Cleaning](#)

**Related references**

[Paper or Media Type Settings](#)

**Related tasks**

[Checking Ink Levels on Your Product](#)  
[Selecting Basic Print Settings - Windows](#)  
[Selecting Basic Print Settings - Mac](#)

**Related topics**

[Loading Paper](#)  
[Refilling Ink](#)

## Blurry or Smearred Printout

If your printouts are blurry or smearred, try these solutions:

- Make sure your paper is not damp, curled, old, or loaded incorrectly in your product.
- Slide the edge guides to the edges of the paper.
- Use a support sheet with special paper, or load special paper one sheet at a time.
- Make sure your paper meets the specifications for your product.
- Use Epson papers to ensure proper saturation and absorption of genuine Epson inks.
- Do not load more than the recommended number of sheets. For plain paper, do not load above the line indicated by the triangle symbol on the edge guide.
- Make sure the paper type setting in your product software matches the type of paper you loaded.
- Make sure you loaded the printable side of the paper correctly for your product.
- If you are printing on thick paper or envelopes, make sure you select the appropriate settings. In Windows, you can also try selecting **Short Grain Paper** in Extended Settings.
- When manually printing 2-sided, make sure the ink is completely dry before loading the paper.
- Remove each sheet from the output tray as it is printed.
- Avoid handling printouts on glossy paper right after printing to allow the ink to set.
- When vertical banding appears or the paper is smearred, clean the paper path.

- When horizontal banding appears or the top or bottom of the paper is smeared, load paper in the correct direction and slide the edge guides to the edges of the paper.
- If you print on both sides of a sheet of paper, smudges may appear on the reverse side of heavily saturated or dark images. If one side of a sheet will contain a lighter image or text, print that side first. Adjust the density and/or ink drying time settings.
- The ink levels may be low and you may need to refill the ink. Visually check the ink levels.
- Run a nozzle check to see if any of the print head nozzles are clogged. Then clean the print head, if necessary.
- Adjust the print quality in the product software.
- Clean the paper path.
- If you printed when the ink levels were too low to be seen in the ink tank windows, refill the ink tanks to the upper lines and run the Power Cleaning utility. Then run a nozzle check to see if print quality has improved.
- If you have not used the product for a long time, run the Power Cleaning utility.

**Note:** Power Cleaning consumes a lot of ink, so run this utility only if you cannot improve print quality by cleaning the print head.

**Note:** Your product will not operate properly while tilted at an angle. Place it on a flat, stable surface that extends beyond the base of the product in all directions.

**Parent topic:** [Solving Print Quality Problems](#)

**Related concepts**

[Print Head Nozzle Check](#)

[Print Head Cleaning](#)

[Print Head Alignment](#)

[Power Cleaning](#)

**Related references**

[Paper or Media Type Settings](#)

[Compatible Epson Papers](#)

**Related tasks**

[Checking Ink Levels on Your Product](#)

[Selecting Basic Print Settings - Windows](#)

[Selecting Basic Print Settings - Mac](#)

[Cleaning the Paper Path](#)

**Related topics**

[Loading Paper](#)

[Refilling Ink](#)

## Faint Printout or Printout Has Gaps

If your printouts are faint or have gaps, try these solutions:

- Run a nozzle check to see if any of the print head nozzles are clogged. Then clean the print head, if necessary.
- The ink levels may be low. Visually check the ink levels.
- Make sure the paper type setting matches the type of paper you loaded.
- Make sure your paper is not damp, curled, old, or loaded incorrectly in your product.
- Align the print head.
- Adjust the print quality in the product software.
- Clean the paper path.
- If you have not used the product for a long time, run the Power Cleaning utility.

**Note:** Power Cleaning consumes a lot of ink, so run this utility only if you cannot improve print quality by cleaning the print head.

- If you cannot solve the problem using head cleaning, you can print immediately from a Windows computer with a mixture of color inks to create composite black. Select the **Use a Mixture of Color Inks to Create Black** setting from **Extended Settings** on the printer driver's Maintenance tab. You can print at **Standard** print quality when the **Paper Type** is **Plain Paper / Bright White Paper**, **Letterhead**, or **Envelope**.

**Parent topic:** [Solving Print Quality Problems](#)

**Related concepts**

[Print Head Nozzle Check](#)

[Print Head Cleaning](#)

[Print Head Alignment](#)

**Related references**

[Paper or Media Type Settings](#)

### **Related tasks**

- [Checking Ink Levels on Your Product](#)
- [Selecting Basic Print Settings - Windows](#)
- [Selecting Basic Print Settings - Mac](#)
- [Cleaning the Paper Path](#)

### **Related topics**

- [Loading Paper](#)
- [Refilling Ink](#)

## **Grainy Printout**

If your printouts are grainy, try these solutions:

- Make sure you loaded the printable side of the paper correctly for your product.
- Select a higher print quality setting and turn off any high speed settings in your product software.
- Run a nozzle check to see if any of the print head nozzles are clogged. Then clean the print head, if necessary.
- Align the print head.
- Adjust the print quality in the product software.
- You may need to increase the image resolution or print a smaller size; see your software documentation.

**Note:** Images from the Internet may be low resolution and not result in a high quality printout.

- If you enlarged the image size in an image-editing program, you need to increase the image resolution setting to retain a high image quality. Increase the image resolution by the same amount you increase the image size. For example, if the image resolution is 300 dpi (dots per inch) and you will double the image size for printing, change the resolution setting to 600 dpi.

**Note:** Higher resolution settings result in larger file sizes, which take longer to process and print. Consider the limitations of your computer system when selecting a resolution, and select the lowest possible resolution that produces acceptable quality to keep file sizes manageable.

**Parent topic:** [Solving Print Quality Problems](#)

### **Related concepts**

- [Print Head Nozzle Check](#)

[Print Head Cleaning](#)  
[Print Head Alignment](#)

**Related tasks**

[Selecting Basic Print Settings - Windows](#)  
[Selecting Basic Print Settings - Mac](#)

**Related topics**

[Loading Paper](#)

## Incorrect Colors

If your printouts have incorrect colors, try these solutions:

- Make sure the paper type setting matches the paper you loaded.
- Make sure the **Black/Grayscale** or **Grayscale** setting is not selected in your printer software.
- If you selected **Standard-Vivid** (Windows) or **Normal-Vivid** (Mac) as the quality setting in the printer software, try selecting **Standard** (Windows) or **Normal** (Mac) instead.
- Run a nozzle check to see if any of the print head nozzles are clogged. Then clean the print head, if necessary.
- The ink levels may be low and you may need to refill the ink. Visually check the ink levels.
- After you print, the colors in your printout need time to set as the ink dries. During this time, the colors may look different than you expect. To speed up drying time, do not stack your printouts on top of each other.
- Your printed colors can never exactly match your on-screen colors. However, you can use a color management system to get as close as possible. Try using the color management options in your printer software.
- Select **Custom** as the **Color Correction** setting on the More Options tab of the printer software, then click **Advanced**. Try selecting a different **Color Management** setting.
- For best results, use genuine Epson paper.
- If you have not used the product for a long time, run the Power Cleaning utility.

**Note:** Power Cleaning consumes a lot of ink, so run this utility only if you cannot improve print quality by cleaning the print head.

**Parent topic:** [Solving Print Quality Problems](#)

**Related concepts**

[Print Head Nozzle Check](#)

[Print Head Cleaning](#)

[Power Cleaning](#)

**Related references**

[Paper or Media Type Settings](#)

[Compatible Epson Papers](#)

**Related tasks**

[Checking Ink Levels on Your Product](#)

[Selecting Basic Print Settings - Windows](#)

[Selecting Basic Print Settings - Mac](#)

**Related topics**

[Refilling Ink](#)

## Solving Scanning Problems

Check these solutions if you have problems scanning with your product.

[Scanning Software Does Not Operate Correctly](#)

[Cannot Start Epson Scan 2](#)

[Scanning is Slow](#)

**Parent topic:** [Solving Problems](#)

### Scanning Software Does Not Operate Correctly

If your scanning software does not operate correctly, try these solutions:

- Make sure your computer has adequate memory and meets the system requirements for your operating system.
- Make sure your computer is not running in a power-saving mode, such as sleep or standby. If so, wake your system and restart your scanning software.
- If you upgraded your operating system but did not reinstall your scanning software, try reinstalling it.
- In Windows, make sure your product is listed as a valid device in the **Scanners and Cameras** control panel.
- Try scanning at a lower resolution or increase the free space on the computer's hard disk. Scanning stops if the total data size reaches the limit.



- Use the Epson Scan 2 Utility on your computer to reset the scanner software settings. If resetting the settings does not solve the problem, uninstall and reinstall the scanner software.

**Parent topic:** [Solving Scanning Problems](#)

#### **Related concepts**

[Uninstall Your Product Software](#)

#### **Related references**

[Windows System Requirements](#)

[Mac System Requirements](#)

## **Cannot Start Epson Scan 2**

If you cannot start Epson Scan 2, try these solutions:

- Make sure your product is turned on and any interface cables are securely connected at both ends.
- If your product is connected to a USB hub, connect it directly to your computer instead.
- Make sure Epson Scan 2 is selected as your scanning program.
- Make sure your computer is not running in a power-saving mode, such as sleep or standby. If so, wake your system and restart Epson Scan 2.
- Check the connection setting and test the connection using Epson Scan 2 Utility:

**Windows 10:** Click  and select **EPSON > Epson Scan 2 Utility**. Make sure the correct product is selected. If necessary, select the **Other** tab and click **Reset**.

**Windows 8.x:** Navigate to the **Apps** screen and select **Epson Scan 2 Utility**. Make sure the correct product is selected. If necessary, select the **Other** tab and click **Reset**.

**Windows (other versions):** Click  or **Start > All Programs** or **Programs > EPSON > Epson Scan 2 > Epson Scan 2 Utility**. Make sure the correct product is selected. If necessary, select the **Other** tab and click **Reset**.

**Mac:** Open the **Applications** folder, click **Epson Software**, and click **Epson Scan 2 Utility**. Make sure the correct product is selected. If necessary, select the **Other** tab and click **Reset**.

- Make sure you do not have multiple versions of Epson Scan 2 installed. If you do, uninstall both versions and install one version.
- If you upgraded your operating system but did not reinstall Epson Scan 2, try reinstalling it.

**Parent topic:** [Solving Scanning Problems](#)

### **Related concepts**

[Uninstall Your Product Software](#)

### **Related topics**

[Starting a Scan](#)

## **Scanning is Slow**

If scanning becomes slow, try these solutions:

- Scan your original at a lower resolution, if possible.
- Make sure your system meets the requirements for your operating system. If you are scanning a high-resolution image, you may need more than the minimum requirements. If necessary, increase your system's memory or reduce the resolution.
- In Epson Scan 2, open the Configuration screen and turn off **Quiet Mode** on the Scan tab.

**Parent topic:** [Solving Scanning Problems](#)

## **Solving Scanned Image Quality Problems**

Check these sections if a scanned image on your computer screen has a quality problem.

[Image Consists of a Few Dots Only](#)

[Line of Dots Appears in All Scanned Images](#)

[Straight Lines in an Image Appear Crooked](#)

[Scanned Image Quality Problems](#)

[Characters are Not Recognized During Conversion to Editable Text \(OCR\)](#)

[Image Colors are Patchy at the Edges](#)

[Ripple Patterns Appear in an Image](#)

[Scanned Image Edges are Cropped](#)

[Resetting the Epson Scan 2 Settings](#)

**Parent topic:** [Solving Problems](#)

## **Image Consists of a Few Dots Only**

If your scanned image consists only of a few dots, try these solutions:

- Make sure you placed your original for scanning facing the correct way.
- Make sure you select the correct **Image Type** for your original.
- Remove any lint or dirt from your original.

- Clean the scanner glass.
- Do not press on the original or the document cover with too much force.

**Parent topic:** [Solving Scanned Image Quality Problems](#)

**Related references**

[Additional Scanning Settings - Main Settings Tab](#)

**Related tasks**

[Placing Originals on the Scanner Glass](#)

## Line of Dots Appears in All Scanned Images

If a line of dots appears in all your scanned images, try these solutions:

- Clean the scanner glass with a soft, dry, lint-free cloth or use a small amount of glass cleaner on the cloth, if necessary. Paper towels are not recommended.

**Caution:** Do not spray glass cleaner directly on the scanner glass.

- Make sure any interface cables are securely connected at both ends.
- Remove any dust or dirt that may have adhered to your original.
- Do not press with too much force on the original or the document cover.
- Keep the document cover closed to prevent dirt or dust from getting inside.

**Parent topic:** [Solving Scanned Image Quality Problems](#)

**Related tasks**

[Cleaning Your Product](#)

## Straight Lines in an Image Appear Crooked

If straight lines in an original appear crooked in a scanned image, make sure to place your original straight when you scan it.

Clean the scanner glass with a soft, dry, lint-free cloth or use a small amount of glass cleaner on the cloth, if necessary. Paper towels are not recommended.

Keep the document cover closed to prevent dirt or dust from getting inside.

**Parent topic:** [Solving Scanned Image Quality Problems](#)

**Related tasks**

[Placing Originals on the Scanner Glass](#)

## Scanned Image Quality Problems

If you encounter quality problems with your scanned image, try these solutions:

### Image is Distorted or Blurry

- Make sure your original is not wrinkled or warped. This may prevent the original from laying flat on the scanner glass.
- Do not move your original or your product during scanning.
- Do not press on the document cover or the original with too much force.
- Your product will not operate properly while tilted at an angle. Place your product on a flat, stable surface that extends beyond its base in all directions.
- Adjust these Epson Scan 2 or Epson ScanSmart settings (if available) and try scanning again:
  - Increase the **Resolution** setting.
  - If the **Image Type** setting is **Black & White**, adjust the **Threshold** setting.
  - If the **Image Type** setting is **Color** or **Grayscale**, select the **Unsharp Mask** setting.
  - If the **Image Type** setting is **Black & White**, select **Text Enhancement**. If the **Image Type** setting is **Color** or **Grayscale**, change the **Text Enhancement** setting to **High**.

### Image is Too Dark

- If the **Image Type** is set to **Color** or **Grayscale**, adjust the **Brightness** setting.
- Check the brightness and contrast settings of your computer monitor.

### Back of Original Image Appears in Scanned Image

- Place a piece of black paper on the back of the original and scan it again.
- Adjust these Epson Scan 2 or Epson ScanSmart settings (if available) and try scanning again:
  - Select the **Advanced Settings** tab and adjust the **Brightness** setting.
  - If the **Image Type** is set to **Black & White**, select **Text Enhancement**. If the **Image Type** is set to **Color** or **Grayscale**, change the **Text Enhancement** setting to **High**.
  - Select **Text Enhancement**.

**Note:** The **Text Enhancement** and **Remove Background** settings depend on the selected **Image Type**.

### Scanned Image Colors Do Not Match Original Colors

Printed colors can never exactly match the colors on your computer monitor because printers and monitors use different color systems: monitors use RGB (red, green, and blue) and printers typically use CMYK (cyan, magenta, yellow, and black).

Check the color matching and color management capabilities of your computer, display adapter, and the software you are using to see if they are affecting the palette of colors you see on your screen.

To adjust the colors in your scanned image, adjust these Epson Scan 2 or Epson ScanSmart settings (if available) and try scanning again:

- If the **Image Type** setting is **Color** or **Grayscale**, adjust the **Contrast** setting.
- If the **Image Type** setting is **Black & White** or **Grayscale**, adjust the **Color Enhance** setting.

Parent topic: [Solving Scanned Image Quality Problems](#)

### Characters are Not Recognized During Conversion to Editable Text (OCR)

If characters in your scanned images are not recognized during OCR conversion, try these solutions:

- Make sure your original is loaded straight on your product.
- Use an original with clear text.
- When saving scanned images as Searchable PDFs, make sure the correct OCR language is selected.
- Adjust the following Epson Scan 2 settings if available, and try scanning again:
  - On the **Main Settings** tab, make sure you select the correct **Image Type** for your original.
  - On the **Main Settings** tab, set the **Resolution** between 200 and 600 dpi.
  - On the **Advanced Settings** tab, select **Text Enhancement** and choose a setting.

**Note:** The **Text Enhancement** setting depends on the selected **Image Type**.

- If the **Image Type** is set to **Black & White**, adjust the **Threshold** setting on the **Advanced Settings** tab. (The **Image Option** must be set to **None**.)

Parent topic: [Solving Scanned Image Quality Problems](#)

### Image Colors are Patchy at the Edges

If you are scanning a thick or warped original, cover its edges with paper to block external light as you scan it.

Parent topic: [Solving Scanned Image Quality Problems](#)

## Ripple Patterns Appear in an Image

You may see a ripple pattern (called a moiré) in scanned images of printed documents. This is caused by interference from differing pitches in the scanner's screen and your original's halftone screen. To reduce this effect, adjust these Epson Scan 2 settings (if available) and try scanning again:

- Select the **Descreening** setting.
- Select a lower **Resolution** setting.

**Parent topic:** [Solving Scanned Image Quality Problems](#)

### Related references

[Additional Scanning Settings - Main Settings Tab](#)

[Additional Scanning Settings - Advanced Settings Tab](#)

## Scanned Image Edges are Cropped

If the edges of a scanned image are cropped, make sure your original is placed correctly for scanning. If necessary, move your original away from the edges of the scanner glass slightly.

In the Epson Scan 2 or Epson ScanSmart settings, set the **Edge Fill** setting to **None**.

When scanning using Epson ScanSmart and placing multiple originals on the scanner glass, make sure there is a gap of at least 0.8 in. (20 mm) between the originals.



**Parent topic:** [Solving Scanned Image Quality Problems](#)

### Related tasks

[Placing Originals on the Scanner Glass](#)

## Resetting the Epson Scan 2 Settings

If you continue to experience image quality problems after trying all possible solutions, you may need to reset the Epson Scan 2 settings using the Epson Scan 2 Utility.

1. Do one of the following to start the Epson Scan 2 Utility:
  - **Windows 10:** Click  > **EPSON** > **Epson Scan 2 Utility**.
  - **Windows 8.x:** Navigate to the **Apps** screen and select **Epson Scan 2 Utility**.
  - **Windows (other versions):** Click  or **Start**, and select **All Programs** or **Programs**. Select **EPSON** > **Epson Scan 2** > **Epson Scan 2 Utility**.
  - **Mac:** Open the **Applications** folder, open the **Epson Software** folder, and select **Epson Scan 2 Utility**.

2. Click the **Other** tab.
3. Click **Reset** and confirm your choice.

**Note:** If resetting the Epson Scan 2 settings does not solve your problem, uninstall Epson Scan 2 and re-install it.

**Parent topic:** [Solving Scanned Image Quality Problems](#)

## Uninstall Your Product Software

If you have a problem that requires you to uninstall and re-install your software, follow the instructions for your operating system.



[Uninstalling Product Software - Windows](#)

[Uninstalling Product Software - Mac](#)

**Parent topic:** [Solving Problems](#)

## Uninstalling Product Software - Windows

You can uninstall and then re-install your product software to solve certain problems.

1. Turn off the product.
2. Disconnect any interface cables.
3. Do one of the following:
  - **Windows 10:** Click  and select  (Settings) > **Apps** or **System** > **Apps & features**. Then select the program you want to uninstall and select **Uninstall**.
  - **Windows 8.x:** Navigate to the **Apps** screen and select **Control Panel** > **Programs** > **Programs and Features**. Select the uninstall option for your Epson product, then select **Uninstall/Change**.

**Note:** If you see a **User Account Control** window, click **Yes** or **Continue**.

Select your product again, if necessary, then select **OK**, and click **Yes** to confirm the uninstallation.

- **Windows (other versions):** Click  or **Start**, and select **All Programs** or **Programs**. Select **EPSON**, select your product, then click **EPSON Printer Software Uninstall**.

**Note:** If you see a **User Account Control** window, click **Yes** or **Continue**.

In the next window, select your product and click **OK**. Then follow any on-screen instructions.

4. Do one of the following to uninstall Epson Event Manager, then follow any on-screen instructions:
  - **Windows 10/8.x:** Select **Epson Event Manager** and click **Uninstall**.
  - **Windows 7/Windows Vista:** Open the Windows **Control Panel** utility. Select **Programs and Features**. (In Classic view, select **Programs** and click **Uninstall a program**.) Select **Epson Event Manager** and click **Uninstall/Change**.
5. Do one of the following to uninstall Epson Scan 2, then follow any on-screen instructions:
  - **Windows 10:** Select **Epson Scan 2** and click **Uninstall**.
  - **Windows 8.x/Windows 7/Windows Vista:** Select **Epson Scan 2** and click **Uninstall/Change**.
6. Do one of the following to uninstall Epson ScanSmart, then follow any on-screen instructions:
  - **Windows 10:** Select **Epson ScanSmart** and click **Uninstall**.
  - **Windows 8.x/Windows 7/Windows Vista:** Select **Epson ScanSmart** and click **Uninstall/Change**.
7. Restart your computer, then see the *Start Here* sheet to re-install your software.

**Note:** If you find that re-installing your product software does not solve a problem, contact Epson.

**Parent topic:** [Uninstall Your Product Software](#)

## Uninstalling Product Software - Mac

In most cases, you do not need to uninstall your product software before re-installing it. However, you can download the Uninstaller utility from the Epson support website to uninstall your product software as described here.

**Note:** If you find that re-installing your product software does not solve a problem, contact Epson.

1. To download the Uninstaller utility, visit [latin.epson.com/support](http://latin.epson.com/support) and select your product.
2. Click **Downloads**.
3. Select your operating system, click **Utilities**, locate the Uninstaller utility, and click **Download**.
4. Run the file you downloaded.
5. Double-click the **Uninstaller** icon.
6. In the Epson Uninstaller screen, select the checkbox for each software program you want to uninstall.



7. Click **Uninstall**.
8. Follow the on-screen instructions to uninstall the software.
9. Reinstall your product software.

**Note:** If you uninstall the printer driver and your product name remains in the **Print & Fax, Print & Scan,** or **Printers & Scanners** window, select your product name and click the – (remove) icon to remove it.

**Parent topic:** [Uninstall Your Product Software](#)

## Where to Get Help

If you need additional help with your Epson product, contact Epson.

Epson provides these technical support services:

### Internet Support

Visit Epson's support website at [latin.epson.com/support](http://latin.epson.com/support) for solutions to common problems. You can download drivers and documentation, get FAQs and troubleshooting advice, or e-mail Epson with your questions.

### Speak to a Support Representative

Before you call Epson for support, please have the following information ready:

- Product name
- Product serial number (located on a label on the product)
- Proof of purchase (such as a store receipt) and date of purchase
- Computer configuration
- Description of the problem

Then call:

| Country   | Telephone                           |
|-----------|-------------------------------------|
| Argentina | (54 11) 5167-0300<br>0800-288-37766 |
| Bolivia*  | 800-100-116                         |

| Country             | Telephone   |
|---------------------|---|
| Brazil              | State capitals and metropolitan areas: 3004-6627<br>Other areas: 0800-377-6627 / 0800-EPSONBR |
| Chile               | (56 2) 2484-3400  |
| Colombia            | Bogota: (57 1) 592-2200<br>Other cities: 018000-915235  |
| Costa Rica          | 800-377-6627  |
| Dominican Republic* | 1-888-760-0068  |
| Ecuador*            | 1-800-000-044   |
| El Salvador*        | 800-6570  |
| Guatemala*          | 1-800-835-0358  |
| Mexico              | Mexico City: (52 55) 1323-2052<br>Other cities: 01-800-087-1080                               |
| Nicaragua*          | 00-1-800-226-0368   |
| Panama*             | 00-800-052-1376   |
| Paraguay            | 009-800-521-0019  |
| Peru                | Lima: (51 1) 418-0210<br>Other cities: 0800-10126   |
| Uruguay             | 00040-5210067   |
| Venezuela           | (58 212) 240-1111   |

\* Contact your local phone company to call this toll-free number from a mobile phone.

If your country does not appear in the list, contact the sales office in the nearest country. Toll or long distance charges may apply.

### **Purchase Supplies and Accessories**

You can purchase genuine Epson ink and paper from an Epson authorized reseller. To find the nearest reseller, visit [latin.epson.com](http://latin.epson.com) or call your nearest Epson sales office.

**Parent topic:** [Solving Problems](#)

---

# Technical Specifications

These sections list the technical specifications for your product.

[Windows System Requirements](#)

[Mac System Requirements](#)

[Paper Specifications](#)

[Printable Area Specifications](#)

[Scanning Specifications](#)

[Ink Specifications](#)

[Dimension Specifications](#)

[Electrical Specifications](#)

[Environmental Specifications](#)

[Interface Specifications](#)

[Network Interface Specifications](#)

## Windows System Requirements

To use your product and its software, your computer should use one of these Microsoft operating systems:

- Windows 10
- Windows 8.x
- Windows 7
- Windows Vista
- Windows Server 2019
- Windows Server 2016
- Windows Server 2012 R2
- Windows Server 2012
- Windows Server 2008 R2
- Windows Server 2008
- Windows Server 2003 R2
- Windows Server 2003 SP2 or later

Windows Server supports only the printer driver and Epson Scan 2; any additional included software is not supported.

**Note:** For the latest product software available for your operating system, visit the Epson support site at [latin.epson.com/support](http://latin.epson.com/support), select your product, and select **Downloads**.

**Parent topic:** [Technical Specifications](#)

## Mac System Requirements

To use your product and its software, your Mac should use one of these operating systems:

- macOS 11.x
- macOS 10.15.x
- macOS 10.14.x
- macOS 10.13.x
- macOS 10.12.x
- OS X 10.11.x
- OS X 10.10.x
- OS X 10.9.x
- OS X 10.8.x
- OS X 10.7.x

**Note:** For the latest product software available for your operating system, visit the Epson support site at [latin.epson.com/support](http://latin.epson.com/support), select your product, and select **Downloads**.

**Parent topic:** [Technical Specifications](#)

## Paper Specifications

**Note:** Since the quality of any particular brand or type of paper may be changed by the manufacturer at any time, Epson cannot guarantee the quality of any non-Epson brand or type of paper. Always test a sample of paper stock before purchasing large quantities or printing large jobs.

## Single-sheets

### Size

A4 (8.3 × 11.7 inches [210 × 297 mm])  
A6 (4.1 × 5.8 inches [105 × 148 mm])  
Letter (8.5 × 11 inches [216 × 279 mm])  
Legal (8.5 × 14 inches [216 × 356 mm])  
Executive (7.25 × 10.5 inches [184 × 267 mm])  
8.5 × 13 inches (216 × 330 mm)  
Mexico-Oficio (8.5 × 13.4 inches [216 × 340 mm])  
Oficio 9 (8.46 × 12.4 inches [215 × 315 mm])  
4 × 6 inches (102 × 152 mm)  
5 × 7 inches (127 × 178 mm)  
8 × 10 inches (203 × 254 mm)  
3.5 × 5 inches (89 × 127 mm)  
Half Letter (5.5 × 8.5 inches [140 × 216 mm])  
User-defined size paper from 2.12 × 3.39 inches (54 × 86 mm) to 8.5 × 47.24 inches (215.9 × 1200 mm)

### Paper types

Plain paper

**Note:** Your product also supports compatible papers distributed by Epson. See the link at the end of this topic for a list of compatible Epson papers.

### Weight

Plain paper: 17 lb (64 g/m<sup>2</sup>) to 24 lb (90 g/m<sup>2</sup>)

## Envelopes

### Size

No. 10 (4.1 × 9.5 inches [105 × 241 mm])

### Paper types

Plain paper

### Weight

20 lb (75 g/m<sup>2</sup>) to 27 lb (100 g/m<sup>2</sup>)

Parent topic: [Technical Specifications](#)

## Related references

[Compatible Epson Papers](#)

# Printable Area Specifications

**Note:** When printing borderless, quality may decline in the expanded printable area.

## Single sheets - borders

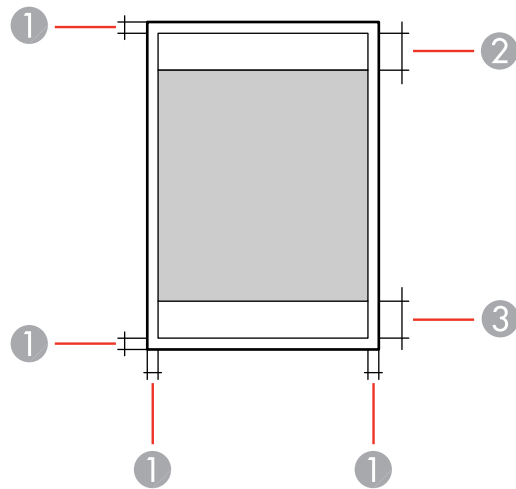

- 1 Top/bottom/left/right margins: 0.12 inch (3 mm) minimum
- 2 Reduced print quality area/top: 1.61 inches (41 mm) minimum
- 3 Reduced print quality area/bottom: 1.46 inches (37 mm) minimum

### Single sheets - borderless

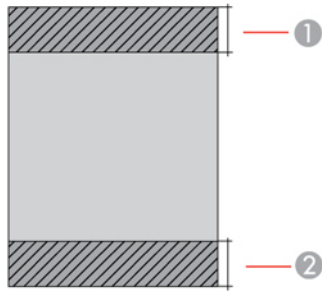

- 1 Reduced print quality area/top: 1.73 inches (44 mm) minimum
- 2 Reduced print quality area/bottom: 1.57 inches (40 mm) minimum

### Envelopes

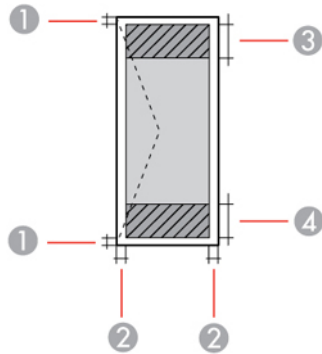

- 1 Left/right margins: 0.12 inch (3 mm) minimum
- 2 Top/bottom margins: 0.12 inch (3 mm) minimum
- 3 Reduced print quality area/right: 0.71 inch (18 mm) minimum
- 4 Reduced print quality area/left: 1.61 inches (41 mm) minimum

Parent topic: [Technical Specifications](#)

## Scanning Specifications

|                             |  |
|-----------------------------|--|
| <b>Scanner type</b>         | Flatbed, color   |
| <b>Photoelectric device</b> | CIS  |
| <b>Effective pixels</b>     | 10200 × 14040 pixels at 1200 dpi   |
| <b>Document size</b>        | Maximum: 8.5 × 11.7 inches (216 × 297 mm)<br>Scanner glass: US letter or A4  |
| <b>Scanning resolution</b>  | 1200 dpi (main scan)<br>2400 dpi (sub scan)  |
| <b>Output resolution</b>    | 50 to 9600 dpi in 1 dpi increments   |
| <b>Image data</b>           | Color:<br>48 bits per pixel internal (16 bits per pixel per color internal)<br>24 bits per pixel external (8 bits per pixel per color external)<br>Grayscale:<br>16 bits per pixel internal<br>8 bits per pixel external<br>Black and white:<br>16 bits per pixel internal<br>1 bit per pixel external |
| <b>Light source</b>         | LED  |

Parent topic: [Technical Specifications](#)

## Ink Specifications

**Note:** This product is designed to work with genuine Epson inks. Non-Epson ink or any other ink not specified for this printer could cause damage not covered by Epson's warranties.

The ink bottles that are used for initial product setup have a lower yield due to the ink charging process. This process is carried out the first time you turn on the printer and guarantees better performance. Yields vary considerably based on print jobs, print settings, paper type, frequency of use, and temperature. Do not load paper before refilling the ink tanks.



Check the ink levels in your product frequently, and refill the ink tanks if necessary.

|                    |   |
|--------------------|---|
| <b>Color</b>       | Cyan, Magenta, Yellow, Black  |
| <b>Ink life</b>    | Opened package: Use as soon as possible.<br>Unopened package: Use before the date on the package has expired.   |
| <b>Temperature</b> | Storage: -4 to 104 °F (-20 to 40 °C)<br>1 month at 104 °F (40 °C)<br>Ink freezes at 5 °F (-15 °C)<br>Ink thaws and is usable after approximately 2 hours at 77 °F (25 °C) |

**Parent topic:** [Technical Specifications](#)

**Related concepts**

[Purchase Epson Ink](#)

## Dimension Specifications

|   |  |
|---|--|
| <b>Height</b>                                 | Stored: 7.0 inches (179 mm)<br>Printing: 10.0 inches (253 mm)  |
| <b>Width</b>                                  | Stored: 14.8 inches (375 mm)<br>Printing: 14.8 inches (375 mm) |
| <b>Depth</b>                                  | Stored: 13.7 inches (347 mm)<br>Printing: 22.8 inches (578 mm) |
| <b>Weight</b><br>(without ink and power cord) | 8.6 lb (3.9 kg)  |

**Parent topic:** [Technical Specifications](#)

## Electrical Specifications

|                            |              |
|----------------------------|--------------|
| <b>Power supply rating</b> | 100 to 240 V |
|----------------------------|--------------|

|                              |  |
|------------------------------|--|
| <b>Input voltage range</b>   | 90 to 264 V  |
| <b>Rated frequency range</b> | 50/60 Hz   |
| <b>Input frequency range</b> | 49.5/60.5 Hz   |
| <b>Rated current</b>         | 0.4 to 0.2 A   |
| <b>Power consumption</b>     | Standalone copying: Approximately 12 W (ISO/IEC24712)<br>Ready mode: Approximately 4.5 W<br>Sleep mode: Approximately 0.7 W<br>Power off mode: Approximately 0.2 W |

Parent topic: [Technical Specifications](#)

## Environmental Specifications

|   |   |
|---|---|
| <b>Temperature</b>                        | Operating: 50 to 95 °F (10 to 35 °C)<br>Storage: -4 to 104 °F (-20 to 40 °C)<br>1 month at 104 °F (40 °C) |
| <b>Humidity</b><br>(without condensation) | Operating: 20 to 80% RH<br>Storage: 5 to 85% RH   |

Parent topic: [Technical Specifications](#)

## Interface Specifications

|                       |   |
|-----------------------|---|
| <b>Interface type</b> | Hi-Speed USB (Device Class for computers); USB 3.0 cables are not supported |
|-----------------------|---|

**Note:** Epson cannot guarantee the operation of externally connected devices.

Parent topic: [Technical Specifications](#)

# Network Interface Specifications

## Wi-Fi

|  |  |
|--|--|
| <b>Standard</b>                                  | IEEE 802.11 b/g/n; IEEE802.11n available only on the 20 MHz channel  |
| <b>Security</b>                                  | WEP (64/128 bit)<br>WPA2-PSK (TKIP/AES), complies with WPA2 with support for WPA/WPA2 Personal<br>WPA3-SAE (AES) |
| <b>Frequency band</b>                            | 2.4 GHz  |
| <b>Communication mode</b>                        | Infrastructure mode<br>Wi-Fi Direct (Simple AP); not supported for IEEE 802.11b                                  |
| <b>Maximum radio frequency power transmitted</b> | 20.0 dBm (EIRP)  |
| <b>Security</b>                                  |  |
| <b>Security protocol</b>                         | SSL/TLS: HTTPS Server/Client, IPPS<br>SNMPv3   |

Parent topic: [Technical Specifications](#)

---

## Notices

Check these sections for important notices about your product.

[Important Safety Instructions](#)

[FCC Compliance Statement](#)

[Binding Arbitration and Class Waiver](#)

[Trademarks](#)

[Copyright Notice](#)

## Important Safety Instructions

Before using your Epson product, read and follow these safety instructions.

[General Printer Safety Instructions](#)

[Wireless Connection Safety Instructions](#)

**Parent topic:** [Notices](#)

## General Printer Safety Instructions

- Be sure to follow all warnings and instructions marked on the printer.
- Use only the type of power source indicated on the printer's label.
- Use only the power cord that comes with the printer. Use of another cord may cause fires or shock. Do not use the cord with any other equipment.
- Make sure the AC power cord meets the relevant local safety standard.
- Place the printer near a wall outlet where the plug can be easily unplugged.
- Avoid plugging the printer into an outlet on the same circuit as a photo copier or air control system that regularly switches on and off, or on an outlet controlled by a wall switch or timer.
- Do not let the power cord become damaged or frayed.
- If you use an extension cord with the printer, make sure the total ampere rating of the devices plugged into the extension cord does not exceed the cord's ampere rating. Also, make sure the total ampere rating of all devices plugged into the wall outlet does not exceed the wall outlet's ampere rating.
- Always turn off the printer using the power button, and wait until the power light stops flashing before unplugging the printer or cutting off power to the electrical outlet.
- Place the printer on a flat, stable surface that extends beyond its base in all directions. It will not operate properly if it is tilted or at an angle.

- Keep your product at least 8.7 inches (22 cm) away from cardiac pacemakers to prevent your product's radio waves from affecting the operation of the pacemaker.
- Leave enough space above the printer to fully raise the document cover.
- Leave enough space in front of the printer for the paper to be fully ejected.
- Avoid locations that are subject to rapid changes in heat or humidity, shocks or vibrations, or dust.
- Do not place the printer near a radiator or heating vent or in direct sunlight.
- Leave enough room around the printer for sufficient ventilation. Do not block or cover openings in the case or insert objects through the slots.
- Keep the printer away from potential sources of electromagnetic interference, such as loudspeakers or the base units of cordless telephones.
- When connecting the printer to a computer or other device with a cable, ensure the correct orientation of the connectors. Each connector has only one correct orientation. Inserting a connector in the wrong orientation may damage both devices connected by the cable.
- Do not put your hand inside the printer while it is printing.
- Do not touch the flat white cable inside the printer.
- Do not move the print head by hand; this may damage the printer.
- Do not spill liquid on the printer and do not handle the printer with wet hands.
- Do not use aerosol products that contain flammable gases inside or around the printer. Doing so may cause fire.
- Except as specifically explained in your documentation, do not attempt to service the printer yourself.
- Unplug the printer and refer servicing to qualified service personnel under the following conditions: if the power cord or plug is damaged; if liquid has entered the product; if the product has been dropped or the case damaged; if the product does not operate normally or exhibits a distinct change in performance. Adjust only those controls that are covered by the operating instructions.
- If damage occurs to the plug, replace the cord set or consult a qualified electrician. If there are fuses in the plug, make sure you replace them with fuses of the correct size and rating.
- Unplug the power cord from the electrical outlet if you are not going to use the printer for an extended period.
- Before transporting the printer, make sure that the print head is in the home (far right) position.
- When storing or transporting the printer, do not tilt it, stand it on its side, or turn it upside down; otherwise, ink may leak.

- Some users that print extensively may receive a message informing them that the ink waste pad is full. The duration of the pad depends on the amount of use and usage conditions such as high humidity, heat or dusty conditions that require more cleaning cycles. The Epson Status Monitor and warning light on the control panel will indicate when the waste pad needs to be replaced. The ink pad is not a user serviceable part. Please seek service from an Epson Authorized Service Center or consider a new printer if your printing needs have changed or the printer has had a long period of extensive use.

**Parent topic:** [Important Safety Instructions](#)

## Wireless Connection Safety Instructions

Radio waves from this product may adversely affect the operation of medical equipment or automatically controlled devices, such as pacemakers, automatic doors or fire alarms. When using this product near such devices or inside a medical facility, follow the directions from authorized staff members at the facility, and follow all posted warnings and directions on the device to avoid causing an accident.

**Parent topic:** [Important Safety Instructions](#)

## FCC Compliance Statement

### For United States Users

This equipment has been tested and found to comply with the limits for a Class B digital device, pursuant to Part 15 of the FCC Rules. These limits are designed to provide reasonable protection against harmful interference in a residential installation. This equipment generates, uses, and can radiate radio frequency energy and, if not installed and used in accordance with the instructions, may cause harmful interference to radio or television reception. However, there is no guarantee that interference will not occur in a particular installation. If this equipment does cause interference to radio and television reception, which can be determined by turning the equipment off and on, the user is encouraged to try to correct the interference by one or more of the following measures:

- Reorient or relocate the receiving antenna.
- Increase the separation between the equipment and receiver.
- Connect the equipment into an outlet on a circuit different from that to which the receiver is connected.
- Consult the dealer or an experienced radio/TV technician for help.

### WARNING

The connection of a non-shielded equipment interface cable to this equipment will invalidate the FCC Certification or Declaration of this device and may cause interference levels which exceed the limits established by the FCC for this equipment. It is the responsibility of the user to obtain and use a shielded equipment interface cable with this device. If this equipment has more than one interface connector, do

not leave cables connected to unused interfaces. Changes or modifications not expressly approved by the manufacturer could void the user's authority to operate the equipment.

### **For Canadian Users**

CAN ICES-3(B)/NMB-3(B)

Parent topic: [Notices](#)

## **Binding Arbitration and Class Waiver**

### **1. DISPUTES, BINDING INDIVIDUAL ARBITRATION, AND WAIVER OF CLASS ACTIONS AND CLASS ARBITRATIONS**

**1.1 Disputes.** The terms of this Section 1 shall apply to all Disputes between you and Epson. The term "Dispute" is meant to have the broadest meaning permissible under law and includes any dispute, claim, controversy or action between you and Epson arising out of or relating to this Agreement, Epson branded products (hardware and including any related software), or other transaction involving you and Epson, whether in contract, warranty, misrepresentation, fraud, tort, intentional tort, statute, regulation, ordinance, or any other legal or equitable basis. "DISPUTE" DOES NOT INCLUDE IP CLAIMS, or more specifically, a claim or cause of action for (a) trademark infringement or dilution, (b) patent infringement, (c) copyright infringement or misuse, or (d) trade secret misappropriation (an "IP Claim"). You and Epson also agree, notwithstanding Section 1.6, that a court, not an arbitrator, may decide if a claim or cause of action is for an IP Claim.

**1.2 Binding Arbitration.** You and Epson agree that all Disputes shall be resolved by binding arbitration according to this Agreement. **ARBITRATION MEANS THAT YOU WAIVE YOUR RIGHT TO A JUDGE OR JURY IN A COURT PROCEEDING AND YOUR GROUNDS FOR APPEAL ARE LIMITED.** Pursuant to this Agreement, binding arbitration shall be administered by JAMS, a nationally recognized arbitration authority, pursuant to its code of procedures then in effect for consumer related disputes, but excluding any rules that permit joinder or class actions in arbitration (for more detail on procedure, see Section 1.6 below). You and Epson understand and agree that (a) the Federal Arbitration Act (9 U.S.C. §1, et seq.) governs the interpretation and enforcement of this Section 1, (b) this Agreement memorializes a transaction in interstate commerce, and (c) this Section 1 shall survive termination of this Agreement.

**1.3 Pre-Arbitration Steps and Notice.** Before submitting a claim for arbitration, you and Epson agree to try, for sixty (60) days, to resolve any Dispute informally. If Epson and you do not reach an agreement to resolve the Dispute within the sixty (60) days, you or Epson may commence an arbitration. Notice to Epson must be addressed to: Epson America, Inc., ATTN: Legal Department, 3131 Katella Ave., Los Alamitos, CA 90720 (the "Epson Address"). The Dispute Notice to you will be sent to the most recent address Epson has in its records for you. For this reason, it is important to notify us if your address changes by emailing us at [EAILEgal@ea.epson.com](mailto:EAILEgal@ea.epson.com) or writing us at the Epson Address above. Notice of

the Dispute shall include the sender's name, address and contact information, the facts giving rise to the Dispute, and the relief requested (the "Dispute Notice"). Following receipt of the Dispute Notice, Epson and you agree to act in good faith to resolve the Dispute before commencing arbitration.

**1.4 Small Claims Court.** Notwithstanding the foregoing, you may bring an individual action in the small claims court of your state or municipality if the action is within that court's jurisdiction and is pending only in that court.

**1.5 WAIVER OF CLASS ACTIONS AND CLASS ARBITRATIONS. YOU AND EPSON AGREE THAT EACH PARTY MAY BRING DISPUTES AGAINST THE OTHER PARTY ONLY IN AN INDIVIDUAL CAPACITY, AND NOT AS A PLAINTIFF OR CLASS MEMBER IN ANY CLASS OR REPRESENTATIVE PROCEEDING, INCLUDING WITHOUT LIMITATION FEDERAL OR STATE CLASS ACTIONS, OR CLASS ARBITRATIONS. CLASS ACTION LAWSUITS, CLASS-WIDE ARBITRATIONS, PRIVATE ATTORNEY-GENERAL ACTIONS, AND ANY OTHER PROCEEDING WHERE SOMEONE ACTS IN A REPRESENTATIVE CAPACITY ARE NOT ALLOWED. ACCORDINGLY, UNDER THE ARBITRATION PROCEDURES OUTLINED IN THIS SECTION, AN ARBITRATOR SHALL NOT COMBINE OR CONSOLIDATE MORE THAN ONE PARTY'S CLAIMS WITHOUT THE WRITTEN CONSENT OF ALL AFFECTED PARTIES TO AN ARBITRATION PROCEEDING.**

**1.6 Arbitration Procedure.** If you or Epson commences arbitration, the arbitration shall be governed by the rules of JAMS that are in effect when the arbitration is filed, excluding any rules that permit arbitration on a class or representative basis (the "JAMS Rules"), available at <https://www.jamsadr.com/about/> or by calling +1-949-224-1810 (from outside the U.S.) or 1-800-352-5267 (from within the U.S.), and under the rules set forth in this Agreement. All Disputes shall be resolved by a single neutral arbitrator, and both parties shall have a reasonable opportunity to participate in the selection of the arbitrator. The arbitrator is bound by the terms of this Agreement. The arbitrator, and not any federal, state or local court or agency, shall have exclusive authority to resolve all disputes arising out of or relating to the interpretation, applicability, enforceability or formation of this Agreement, including any claim that all or any part of this Agreement is void or voidable. Notwithstanding this broad delegation of authority to the arbitrator, a court may determine the limited question of whether a claim or cause of action is for an IP Claim, which is excluded from the definition of "Disputes" in Section 1.1 above. The arbitrator shall be empowered to grant whatever relief would be available in a court under law or in equity. The arbitrator may award you the same damages as a court could, and may award declaratory or injunctive relief only in favor of the individual party seeking relief and only to the extent necessary to provide relief warranted by that party's individual claim. In some instances, the costs of arbitration can exceed the costs of litigation and the right to discovery may be more limited in arbitration than in court. The arbitrator's award is binding and may be entered as a judgment in any court of competent jurisdiction.

You may choose to engage in arbitration hearings by telephone. Arbitration hearings not conducted by telephone shall take place in a location reasonably accessible from your primary residence, or in Orange County, California, at your option.



a) Initiation of Arbitration Proceeding. If either you or Epson decides to arbitrate a Dispute, both parties agree to the following procedure:

(i) Write a Demand for Arbitration. The demand must include a description of the Dispute and the amount of damages sought to be recovered. You can find a copy of a Demand for Arbitration at <http://www.jamsadr.com> ("Demand for Arbitration").

(ii) Send three copies of the Demand for Arbitration, plus the appropriate filing fee, to: JAMS, 500 North State College Blvd., Suite 600 Orange, CA 92868, U.S.A.

(iii) Send one copy of the Demand for Arbitration to the other party (same address as the Dispute Notice), or as otherwise agreed by the parties.

b) Hearing Format. During the arbitration, the amount of any settlement offer made shall not be disclosed to the arbitrator until after the arbitrator determines the amount, if any, to which you or Epson is entitled. The discovery or exchange of non-privileged information relevant to the Dispute may be allowed during the arbitration.

c) Arbitration Fees. Epson shall pay, or (if applicable) reimburse you for, all JAMS filings and arbitrator fees for any arbitration commenced (by you or Epson) pursuant to provisions of this Agreement.

d) Award in Your Favor. For Disputes in which you or Epson seeks \$75,000 or less in damages exclusive of attorney's fees and costs, if the arbitrator's decision results in an award to you in an amount greater than Epson's last written offer, if any, to settle the Dispute, Epson will: (i) pay you \$1,000 or the amount of the award, whichever is greater; (ii) pay you twice the amount of your reasonable attorney's fees, if any; and (iii) reimburse you for any expenses (including expert witness fees and costs) that your attorney reasonably accrues for investigating, preparing, and pursuing the Dispute in arbitration. Except as agreed upon by you and Epson in writing, the arbitrator shall determine the amount of fees, costs, and expenses to be paid by Epson pursuant to this Section 1.6d).

e) Attorney's Fees. Epson will not seek its attorney's fees and expenses for any arbitration commenced involving a Dispute under this Agreement. Your right to attorney's fees and expenses under Section 1.6d) above does not limit your rights to attorney's fees and expenses under applicable law; notwithstanding the foregoing, the arbitrator may not award duplicative awards of attorney's fees and expenses.

**1.7 Opt-out. You may elect to opt-out (exclude yourself) from the final, binding, individual arbitration procedure and waiver of class and representative proceedings specified in this Agreement by sending a written letter to the Epson Address within thirty (30) days of your assent to this Agreement (including without limitation the purchase, download, installation of the Software or other applicable use of Epson Hardware, products and services) that specifies (i) your name, (ii) your mailing address, and (iii) your request to be excluded from the final, binding individual arbitration procedure and waiver of class and representative proceedings specified in this Section 1. In the event that you opt-out consistent with the procedure set forth above, all other terms shall continue to apply, including the requirement to provide notice prior to litigation.**

**1.8 Amendments to Section 1.** Notwithstanding any provision in this Agreement to the contrary, you and Epson agree that if Epson makes any future amendments to the dispute resolution procedure and class action waiver provisions (other than a change to Epson's address) in this Agreement, Epson will obtain your affirmative assent to the applicable amendment. If you do not affirmatively assent to the applicable amendment, you are agreeing that you will arbitrate any Dispute between the parties in accordance with the language of this Section 1 (or resolve disputes as provided for in Section 1.7, if you timely elected to opt-out when you first assented to this Agreement).

**1.9 Severability.** If any provision in this Section 1 is found to be unenforceable, that provision shall be severed with the remainder of this Agreement remaining in full force and effect. **The foregoing shall not apply to the prohibition against class or representative actions as provided in Section 1.5. This means that if Section 1.5 is found to be unenforceable, the entire Section 1 (but only Section 1) shall be null and void.**

Parent topic: [Notices](#)

## Trademarks

EPSON® and Epson Smart Panel® are registered trademarks, EPSON Exceed Your Vision is a registered logomark, and Epson Connect™ and Remote Print™ are trademarks of Seiko Epson Corporation.

Windows is a registered trademark of Microsoft Corporation in the United States and/or other countries.

Apple, Mac, macOS, and OS X are trademarks of Apple Inc., registered in the U.S. and other countries.

Google® is a registered trademark and Android™, Chromebook™, Gmail™, Google Chrome™ and Google Play™ are trademarks of Google LLC.

Wi-Fi Direct® is a registered trademark of Wi-Fi Alliance®.

General Notice: Other product names used herein are for identification purposes only and may be trademarks of their respective owners. Epson disclaims any and all rights in those marks.



Parent topic: [Notices](#)

## Copyright Notice

All rights reserved. No part of this publication may be reproduced, stored in a retrieval system, or transmitted in any form or by any means, electronic, mechanical, photocopying, recording, or otherwise,

without the prior written permission of Seiko Epson Corporation. The information contained herein is designed only for use with this Epson product. Epson is not responsible for any use of this information as applied to other products.

Neither Seiko Epson Corporation nor its affiliates shall be liable to the purchaser of this product or third parties for damages, losses, costs, or expenses incurred by purchaser or third parties as a result of: accident, misuse, or abuse of this product or unauthorized modifications, repairs, or alterations to this product, or (excluding the U.S.) failure to strictly comply with Seiko Epson Corporation's operating and maintenance instructions.

Seiko Epson Corporation shall not be liable for any damages or problems arising from the use of any options or any consumable products other than those designated as Original Epson Products or Epson Approved Products by Seiko Epson Corporation.

Seiko Epson Corporation shall not be held liable for any damage resulting from electromagnetic interference that occurs from the use of any interface cables other than those designated as Epson approved Products by Seiko Epson Corporation.

This information is subject to change without notice.

[libTIFF Software Acknowledgment](#)

[A Note Concerning Responsible Use of Copyrighted Materials](#)

[Default Delay Times for Power Management for Epson Products](#)

[Copyright Attribution](#)

**Parent topic:** [Notices](#)

## **libTIFF Software Acknowledgment**

Copyright © 1988-1997 Sam Leffler

Copyright © 1991-1997 Silicon Graphics, Inc.

Permission to use, copy, modify, distribute, and sell this software and its documentation for any purpose is hereby granted without fee, provided that (i) the above copyright notices and this permission notice appear in all copies of the software and related documentation, and (ii) the names of Sam Leffler and Silicon Graphics may not be used in any advertising or publicity relating to the software without the specific, prior written permission of Sam Leffler and Silicon Graphics.

THE SOFTWARE IS PROVIDED "AS-IS" AND WITHOUT WARRANTY OF ANY KIND, EXPRESS, IMPLIED OR OTHERWISE, INCLUDING WITHOUT LIMITATION, ANY WARRANTY OF MERCHANTABILITY OR FITNESS FOR A PARTICULAR PURPOSE.

IN NO EVENT SHALL SAM LEFFLER OR SILICON GRAPHICS BE LIABLE FOR ANY SPECIAL, INCIDENTAL, INDIRECT OR CONSEQUENTIAL DAMAGES OF ANY KIND, OR ANY DAMAGES WHATSOEVER RESULTING FROM LOSS OF USE, DATA OR PROFITS, WHETHER OR NOT

ADVISED OF THE POSSIBILITY OF DAMAGE, AND ON ANY THEORY OF LIABILITY, ARISING OUT OF OR IN CONNECTION WITH THE USE OR PERFORMANCE OF THIS SOFTWARE.

**Parent topic:** [Copyright Notice](#)

## **A Note Concerning Responsible Use of Copyrighted Materials**

Epson encourages each user to be responsible and respectful of the copyright laws when using any Epson product. While some countries' laws permit limited copying or reuse of copyrighted material in certain circumstances, those circumstances may not be as broad as some people assume. Contact your legal advisor for any questions regarding copyright law.

**Parent topic:** [Copyright Notice](#)

## **Default Delay Times for Power Management for Epson Products**

This product enters sleep mode after a period of nonuse. You can adjust the time period before power management begins, but increasing the time reduces the product's energy efficiency. Energy savings can be achieved by setting the time to sleep to a shorter interval.

**Parent topic:** [Copyright Notice](#)

## **Copyright Attribution**

© 2021 Epson America, Inc.

10/21

CPD-60185R1

**Parent topic:** [Copyright Notice](#)